

**Price Book**  
**March 1, 2018**  
**Revision B**  
**Dated 01/01/2021**



## TABLE OF CONTENTS

Seating Chart	4-5		
Ganger Location Codes	6		
Nesting Table	7		
Power Location Codes	8		
Power	8-20	Harbor	121-137
Options	21-24	Island	138-144
Credenzas	25-26	Lincoln	145-177
Arlington	27	Pinnacle	178
Coby Apron	28-62	Railway 1.0	179-185
Coby Square	63-107	Supreme	186-201
Empire	108-111	Union 2.0	202-242
Gateway	112-120	Terms & Conditions	243-245

## TABLE TOP EDGE TREATMENTS

Questions? Call 816-774-4050



**Edge code: L73**  
 .75" thick laminate top.  
 EDGE: High Impact 3mm PVC  
 Square corners.



**Edge code: L76**  
 .75" thick laminate top.  
 EDGE: Self edges  
 Square corners.



**Edge code: L3**  
 1.25" thick laminate top.  
 EDGE: High Impact 3mm PVC  
 Square corners.



**Edge code: L11**  
 1.25" thick laminate top.  
 EDGE: Knife 3mm PVC / sealed  
 Square corners.



**Edge code: L6**  
 1.25" thick laminate top.  
 EDGE: Self edges  
 Square corners.



**Edge code: L8**  
 2" thick laminate top.  
 EDGE: Self Edge  
 Square corners.



**Edge code: L20**  
 1.25" thick top.  
 EDGE: Square 1.25" w x 1.25" h  
 Solid wood edges.  
 Mitered square corners.



**Edge code: L33**  
 1.25" thick laminate top.  
 EDGE: Knife 2" w x 1.25" h  
 Solid wood edges.  
 Mitered square corners.



**Edge code: L17**  
 1.25" thick laminate top.  
 EDGE: Bull nose .625" w x 1.25" h  
 Baltic birch (apple ply) wood  
 edges.  
 Mitered square corners.



**Edge code: L18**  
 1.25" thick laminate top.  
 EDGE: Knife 2" w x 1.25" h  
 Baltic birch (apple ply) wood edges.  
 Mitered square corners.

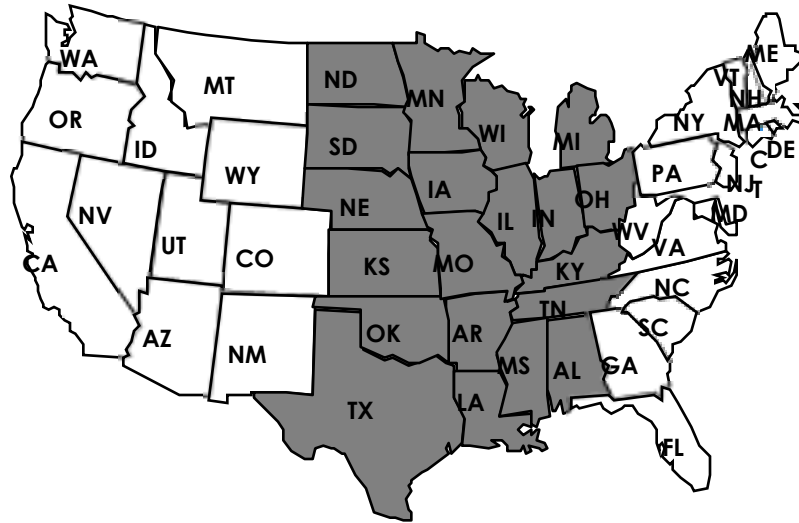

## Freight Zone Map

Grey- Zone 1 Prepaid freight on orders over \$2000 NET  
Orders under \$2000 NET - Add \$200 NET to order

White - Zone 2 Prepaid freight on orders over \$3000 NET  
Orders under \$3000 NET - Add \$300 NET to order

All products are shipped in compliance with the National Motor Freight Classification Code. All products ship unassembled unless otherwise specified by Hi5 Furniture. Freight is prepaid on a dock to dock basis for all orders exceeding zone minimum nets when shipped within the 48 contiguous states excluding Alaska and Hawaii or export.

All orders under zone minimum nets are a flat shipping fee of \$200 net for zone one and \$300 net for zone two, which will be added to the invoice. Hi5 Furniture shall not be held liable for delays caused by strikes, catastrophes, wars, riots or any other cause beyond our control.

Additional expenses will be debited from customer account and billed as "shipping/handling." Examples of additional expenses with variable charges are: Inside delivery, Residential delivery and Lift gate requirements.

Failure to inspect product at time of receipt, note damages on delivery receipt and/or notify Hi5 Furniture of damages within 10 days of the original date of receipt constitutes acceptance of products and a waiver of all claims. Neither Hi5 Furniture nor the carrier will be responsible for concealed damage claims if shipments are left unopened. CONCEALED DAMAGE MUST BE REPORTED WITHIN 7 DAYS FROM DELIVERY TO BE VALID. Any concealed damage reported after 7 days will not be accepted by Hi5 Furniture and is the responsibility of the customer.

All products are loaded on carrier trucks free from defects and/or damage. Responsibility of safe delivery and transport of products is assumed by the carrier upon loading. It is the customer's responsibility that all cartons, crates and packages be opened and inspected at time of delivery for damages or shortages regardless of condition. Any damages found during inspection must be clearly noted on the delivery receipt and packages to be left in original condition as received, failure to do so will void the ability of filing a freight claim. Hi5 Furniture should be notified immediately to assist in filing of freight claim.

# Top Shapes & Seating Chart

www.hi5furniture.com Questions? 816-774-4050

March 1, 2018



### Quarter Round

A	B	Seating Capacity
24"	33.93"	1
30"	42.43"	1
36"	50.87"	2

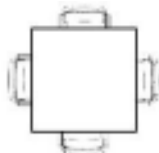
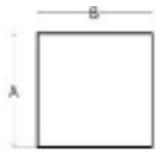

### Square + Round

A	B	Square Seating	Round Seating
24"	24"	2	2
30"	30"	2	3
36"	36"	4	3-4
42"	42"	4	4
48"	48"	4	5
54"	54"	4	5
60"	60"	8	6
72"	72"	8	7-8
84"	84"	8	9
96"	96"	12	10
108"	108"	12	11
120"	120"	16	12

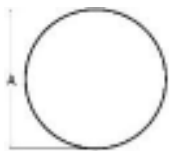

### Half Round

A	B	Seating Capacity
24"	48"	1
30"	60"	2
36"	72"	3
60"	60"	3-4

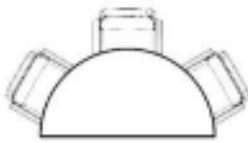
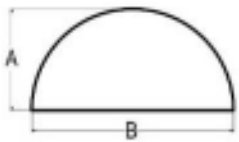

### Trapezoid

A	B	C	D	Seating Capacity
24"	60"	36"	20.75"	1
24"	72"	48"	20.75"	2
30"	60"	30"	26"	3
30"	72"	42"	26"	

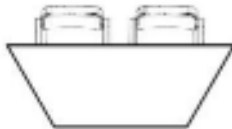
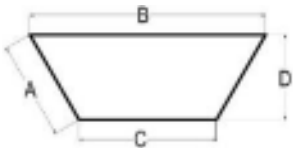

### Crescent

A	B	C	D	E	Seating Capacity
24"	48"	67.81"	31"	33.93"	2
30"	60"	84.81"	38.75"	42.43"	3

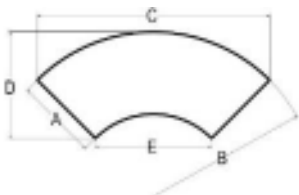

### Guitar Pick

A	B	Seating Capacity
48"	24"	4
60"	30"	4
72"	36"	5
60"	60"	6

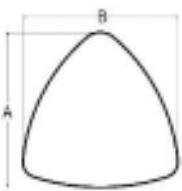

### Hexagon

A	B	C	Seating Capacity
41.57"	24"	48"	3
51.96"	30"	60"	6
62.35"	36"	72"	6
72.75"	42"	84"	6
83.14"	48"	96"	10-12
103.92"	60"	120"	12

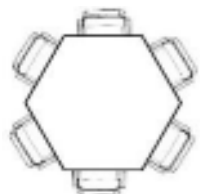
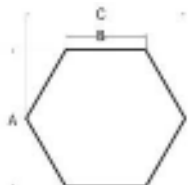

### Arlington Table Tops

A	B	C	Seating Capacity
18"	24"	2"	1

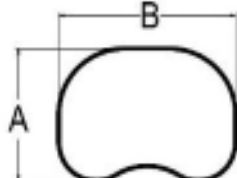
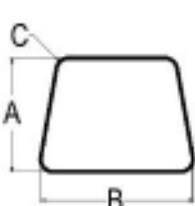
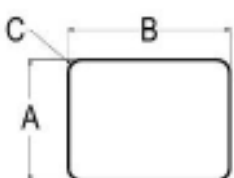

# Seating Chart – based on 30" per seat

www.hi5furniture.com Questions? 816-774-4050

March 1, 2018



**Rectangle**

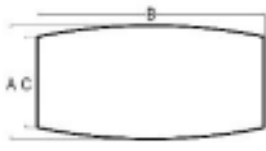

**Boat**

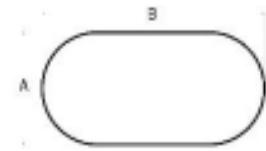
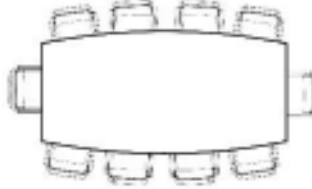

**Racetrack**

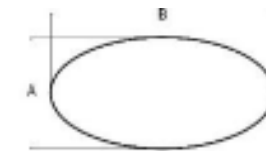
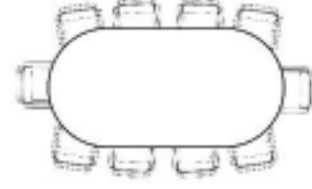

**Elliptical / Oval**

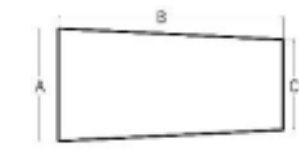
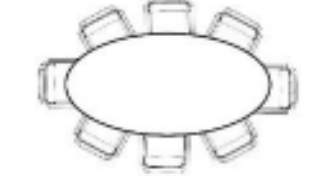

**Tele-Wedge**

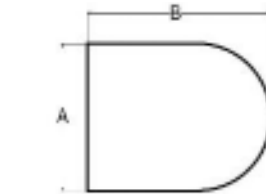

**D Shape**

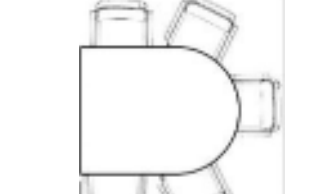

**D Shape**

Seating Capacity

A	B	Seating Capacity
24"	60"	5
24"	72"	5
24"	84"	7
24"	96"	7
30"	60"	5
30"	72"	5
30"	84"	7
30"	96"	7
36"	60"	5
36"	72"	5
36"	84"	7
36"	96"	7
42"	60"	6
42"	72"	6
42"	84"	8
42"	96"	8
48"	60"	6
48"	72"	6
48"	84"	8
48"	96"	8
60"	60"	6
60"	72"	6
60"	84"	8
60"	96"	8

A	B	C	Training	Meeting	A	B	C	Meeting
18	30	NA	1	NA	42	60	30	6
18	60	NA	2	NA	42	72	30	6
18	66	NA	2	NA	42	84	30	6
18	72	NA	2	NA	42	90	30	8
18	84	NA	3	NA	42	96	30	8
18	90	NA	3	NA	42	108	30	10
18	96	NA	3-4	NA	42	120	30	10
18	108	NA	4	NA	42	132	30	10-12
18	120	NA	4-5	NA	42	144	30	12
					42	168	30	12
24	30		1	2	42	192	30	14
24	36		1	2	42	216	30	16
24	48		1	4	42	240	30	168
24	54		2	4	42	264	30	20
24	60		2	6	42	288	30	20-22
24	66		2	6				
24	72		2	6				
24	78		3	6	48	60	36	6-8
24	84		3	6	48	72	36	6-8
24	84		3	6	48	84	36	8-10
24	90		3	8	48	90	36	8-10
24	96		3-4	8	48	96	36	8-10
24	108		4	8	48	108	36	10-12
24	120		4-5	10	48	120	36	10-12
24	132		4-5	10-12	48	132	36	12
24	144		4-5	12	48	144	36	12
					48	168	36	12-14
30	36	18	1	2	48	192	36	14-16
30	48	18	1	4	48	216	36	16-18
30	54	18	2	4	48	240	36	18-20
30	60	18	2	6	48	264	36	20-22
30	66	18	2	6	48	288	36	22
30	72	18	2	6				
30	78	18	3	6	60	72	48	8
30	84	18	3	6	60	84	48	8
30	90	18	3	8	60	90	48	10
30	96	18	3-4	8	60	96	48	10
30	108	18	4	8	60	108	48	12
30	120	18	4-5	10	60	120	48	12
30	132	18	4-5	10-12	60	132	48	12
30	144	18	4-5	12	60	144	48	14
					60	168	48	14
					60	192	48	16
36	48	24	1	4	60	216	48	18
36	54	24	2	4	60	240	48	20
36	60	24	2	6	60	264	48	22
36	66	24	2	6	60	288	48	22
36	72	24	2	6				
36	78	24	3	6				
36	84	24	3	6				
36	90	24	3	8				
36	96	24	3-4	8				
36	108	24	4	8				
36	120	24	4-5	10				
36	132	24	4-5	10-12				
36	144	24	4-5	12				

# Table Ganger Location Codes

www.hi5furniture.com Questions? 816-774-4050

March 1, 2018



Table Ganger Location A



Table Ganger Location B



Table Ganger Location C



Table Ganger Location A



Table Ganger Location A



Table Ganger Location B



Table Ganger Location C

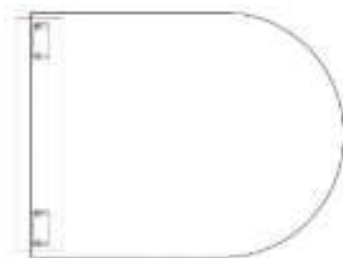

Table Ganger Location D

## Quick Leveling Gangers - Location Codes



QUICK RELEASE LOCATION "A"



QUICK RELEASE LOCATION "B"



QUICK RELEASE LOCATION "W"



QUICK RELEASE LOCATION "B"



QUICK RELEASE LOCATION "A"



QUICK RELEASE LOCATION "B"



QUICK RELEASE LOCATION "C"



QUICK RELEASE LOCATION "W"

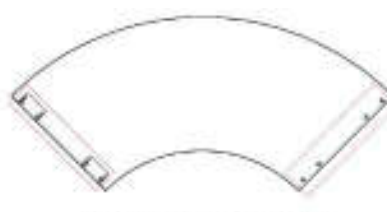

QUICK RELEASE LOCATION "A"



QUICK RELEASE LOCATION "W"

# Nesting Table Storage Information

www.hi5furniture.com Questions? 816-774-4050

March 1, 2018

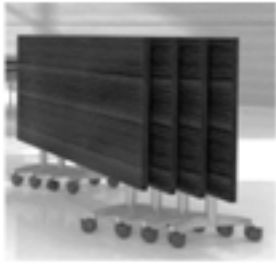

**Supreme Tables**

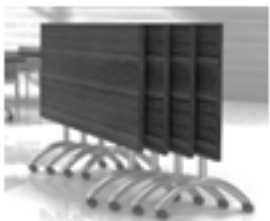
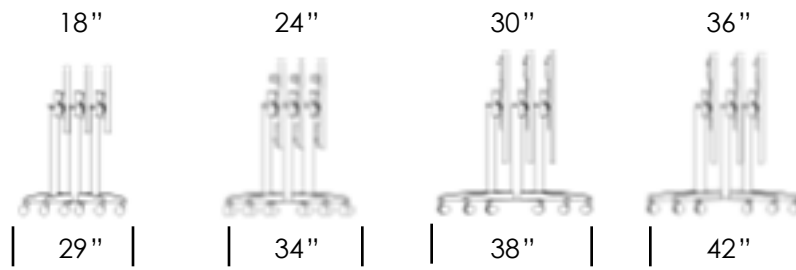

**Gateway Tables**

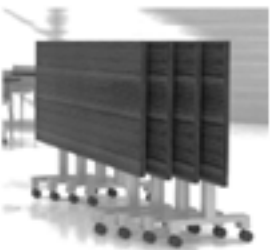
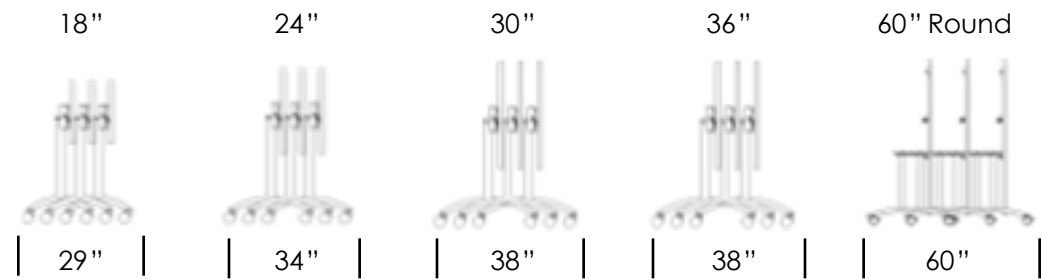

**Harbor Tables**

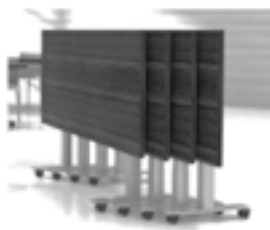
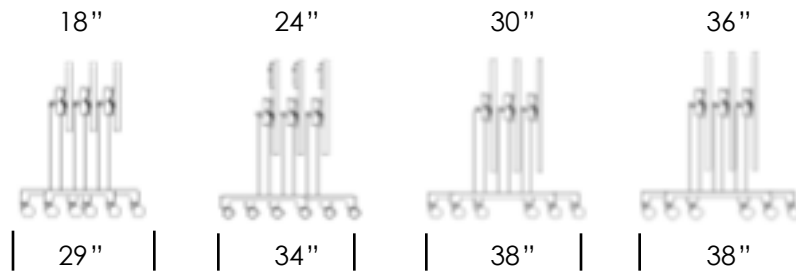

**Empire Tables**

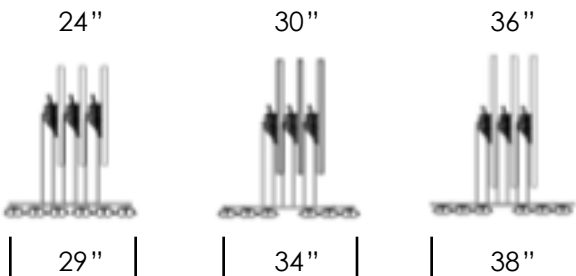

Power location code includes location on the table and the orientation of the power box.

Use these codes for mounting Cove power into Union panel bases or Pinnacle tables.

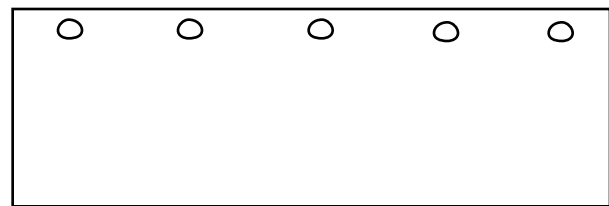
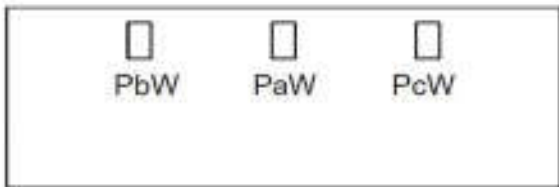
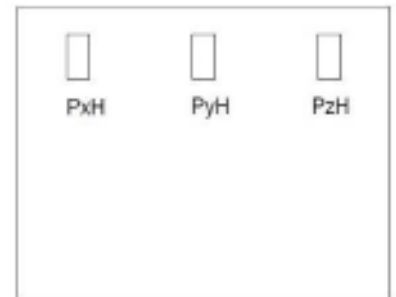
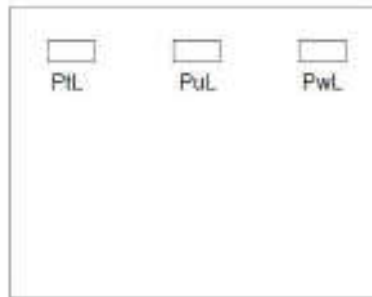

Grommet Location G1 Grommet Location G2 Grommet Location G3 Grommet Location G4 Grommet Location G5

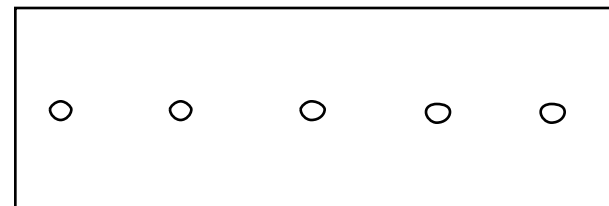
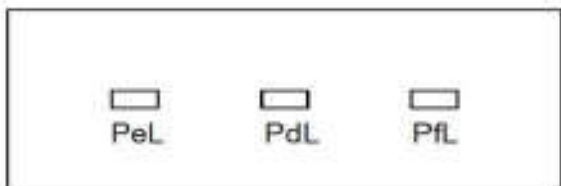

Grommet Location G6 Grommet Location G7 Grommet Location G8 Grommet Location G9 Grommet Location G10



## EDGE MOUNTED LOCATION CODES

Use these codes for mounting Cove power into aprons of Coby Apron tables. Also use these codes for Seclusion power boxes.

The example below location code is: PjL, PmL, PnL, PoL, PrL, PsL

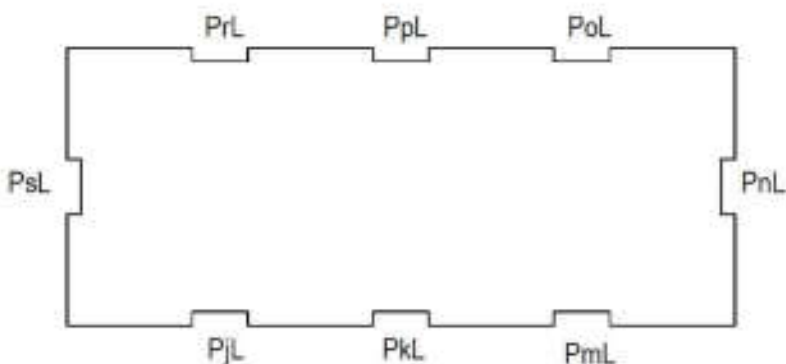



# AV PLATES FOR POWER BOXES

Questions? Call 816-774-4050



Plate #0 Add \$10 to power unit List Price.

Includes:  
One Black Plate



Plate #1 Add \$160 to power unit List Price.

Includes:  
(2) RJ-45 Punch Down Siemen Cat 6 Black



Plate #2 Add \$235 to power unit List Price.

Includes:  
(3) RJ-45 Punch Down Siemen Cat 6 Black



Plate #3 Add \$310 to power unit List Price.

Includes:  
(4) RJ-45 Punch Down Siemen Cat 6 Black



Plate #4 Add \$260 to power unit List Price.

Includes:  
(1) RJ-11 Siemen Cat 3 Black  
(1) RJ-45 Punch Down Siemen Cat 6 Black  
(1) VGA 15 Pin w/ 60" patch cord attached



Plate #6 Add \$230 to power unit List Price.

Includes:  
(1) Mini-Stereo  
(1) RJ-45 Punch Down Siemen Cat 6 Black  
(1) VGA 15 Pin w/ 60" patch cord attached



Plate #7 Add \$305 to power unit List Price.

Includes:  
(1) Mini-Stereo  
(2) RJ-45 Punch Down Siemen Cat 6 Black  
(1) VGA 15 Pin w/ 60" patch cord attached



Plate #9 Add \$130 to power unit List Price.

Includes:  
(1) RJ-11 Siemen Cat 3 Black  
(1) RJ-45 Punch Down Siemen Cat 6 Black



Plate #10 Add \$155 to power unit List Price.

Includes:  
(1) Mini-Stereo  
(1) VGA 15 Pin w/ 60" patch cord attached



Plate #11 Add \$160 to power unit List Price.

Includes:  
(1) RJ-45 Punch Down Siemen Cat 6 Black  
(1) USB Type A/A w/ 72 patch cord attached



Plate #17 Add \$330 to power unit List Price.

Includes:  
(1) HDMI with 36" patch cord attached  
(1) Mini-Stereo  
(1) VGA 15 Pin w/ 60" patch cord attached



Plate #18 Add \$300 to power unit List Price.

Includes:  
(2) RJ-45 Punch Down Siemen Cat 6 Black  
(1) VGA 15 Pin w/ 60" patch cord attached



Plate #19 Add \$160 to power unit List Price.

Includes:  
(2) USB Type A/A w/ 72 patch cord attached



Plate #21 Add \$335 to power unit List Price.

Includes:  
(1) HDMI with 36" patch cord attached  
(2) RJ-45 Punch Down Siemen Cat 6 Black



Plate #23 Add \$205 to power unit List Price.

Includes:  
(1) RJ-11 Siemen Cat 3 Black  
(2) RJ-45 Punch Down Siemen Cat 6 Black



Plate #25 Add \$360 to power unit List Price.

Includes:  
(2) HDMI with 36" patch cord attached



Plate #26 Add \$390 to power unit List Price.

Includes:  
(1) HDMI with 36" patch cord attached  
(1) RJ-45 Punch Down Siemen Cat 6 Black  
(1) VGA 15 Pin w/ 60" patch cord attached



Plate #27 Add \$280 to power unit List Price.

Includes:  
(1) RJ-11 Siemen Cat 3 Black  
(3) RJ-45 Punch Down Siemen Cat 6 Black



Plate #35 Add \$260 to power unit List Price.

Includes:  
(1) HDMI with 36" patch cord attached  
(1) USB Type A/A w/ 72 patch cord attached



Plate #39 Add \$250 to power unit List Price.

Includes:  
(2) RJ-11 Siemen Cat 3 Black  
(2) RJ-45 Punch Down Siemen Cat 6 Black



Plate #40 Add \$315 to power unit List Price.

Includes:  
(1) HDMI with 36" patch cord attached  
(1) VGA 15 Pin w/ 60" patch cord attached



Plate #43 Add \$100 to power unit List Price.

Includes:  
(2) RJ-11 Siemen Cat 3 Black



Plate #44 Add \$380 to power unit List Price.

Includes:  
(1) HDMI with 36" patch cord attached  
(1) RJ-11 Siemen Cat 3 Black  
(2) RJ-45 Punch Down Siemen Cat 6 Black



Plate #45 Add \$430 to power unit List Price.

Includes:  
(1) DVI Inline F/F  
(1) HDMI with 36" patch cord attached

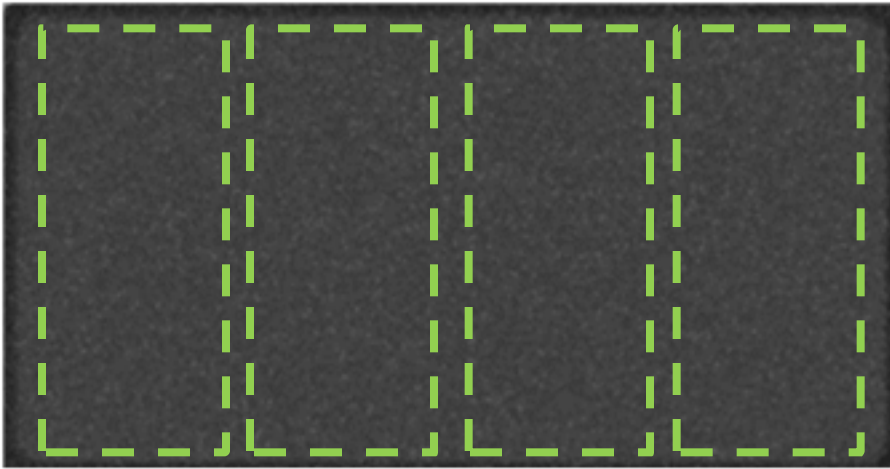

Plate #48 Add \$260 to power unit List Price.

Includes:  
(1) HDMI with 36" patch cord attached  
(1) RJ-45 Punch Down Siemen Cat 6 Black

# BUILD YOUR OWN AV PLATES FOR POWER BOXES

Questions? Call 816-774-4050



Each AV Plate has 4 zones.  
Each jack below shows how many zones the jack takes up in space.



Show n: AV Plate with Cord manager  
Brushes \$35 list per plate



**RJ 45 JACK**

\$85 list per jack

Specs: RJ-45 Punch Down Siemen Cat 6 Black

A/K/A Network jack, data jack, CAT 5 or CAT 6 jack



**VGA - 2 zones**

\$140 list per jack

Specs: VGA 15 Pin w / 60" patch cord attached

A/K/A Projector jack



**RJ 11 JACK**

\$55 list per jack

Specs: RJ-11 Siemen Cat 3 Black

A/K/A Phone Jack



**USB - 2 zones**

\$85 list per jack

Specs: USB Type A/A w / 72 patch cord attached

TO MAKE USB POWERD, MUST ADD TRANSFORMER KIT – ADD \$25 LIST PER TRANSFORMER KIT



**Mini-Stereo**

\$20 list per jack

A/K/A Stereo jack



**HDMI JACK**

\$185 list per jack

Specs: HDMI with 36" patch cord attached

# COVE POWER – NON-LINKING

Questions? Call 816-774-4050



**Specs:** The Cove is a flush mount solution. Choose from power only, power and USB charging, or power, USB charging, and AV plate cut-out configurations. Units are wired for circuit one and include a 108" long soft wired 15 AMP corded plug. Receptacles are spill resistant, 12A, 120 VAC. USB ports are 2.1 AMP. Convenience outlets located underneath units, are available on select units and are shown below. All table tops include cut-out(s) and are predrilled for units. Some assembly required. The Cove is ETL listed.

**? in the Code represents COLOR.**

**Replace ? with one of the following: B-Black, S-Silver, W-Gloss White.**

**Select the Location Code below for your power unit.**

**Select AV plates (if needed), AV plates can be found on page 8-9.**

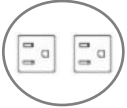

Code: PCVRD2?  
(2) Power  
List Price: \$350 per unit



Code: PCV1USB?  
(1) power, (2) USB  
List Price: \$485 per unit



Code: PCVRD1USB?  
(1) power, (2) USB  
List Price: \$485 per unit

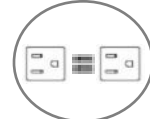

Code: PCVRD2USB?  
(2) power, (2) USB  
List Price: \$485 per unit



Code: PCV2?  
(2) power  
List Price: \$350 per unit



Code: PCV2USB?  
(2) power, (2) USB  
List Price: \$515 per unit



Code: PCV3AV?  
(3) power, (1) AV Plate cut-out  
List Price: \$540 per unit



Code: PCV2C?  
(2) power, (1) outlet under the table  
List Price: \$375 per unit



Code: PCV2USBC2?  
(2) power, (2) USB, (2) outlet under the table  
List Price: \$680 per unit



Code: PCV4AV?  
(4) power, (1) AV Plate cut-out  
List Price: \$625 per unit

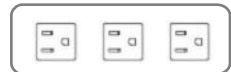

Code: PCV3?  
(3) power  
List Price: \$540 per unit



Code: PCV3USB?  
(3) power, (2) USB  
List Price: \$650 per unit



Code: PCV2USBV?  
(2) power, (2) USB, (1) AV Plate cut-out  
List Price: \$515 per unit



Code: PCV3USBC?  
(3) power, (2) USB, (1) outlet under the table  
List Price: \$650 per unit



Code: PCV3USBV?  
(3) power, (2) USB, (1) AV Plate cut-out  
List Price: \$650 per unit



Code: PCV4?  
(4) power  
List Price: \$595 per unit



Code: PCV4USB?  
(4) power, (2) USB  
List Price: \$650 per unit



Code: PCV4USBV?  
(4) power, (2) USB, (1) AV Plate cut-out  
List Price: \$650 per unit

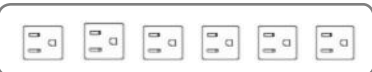

Code: PCV6?  
(6) power  
List Price: \$625 per unit



Code: PCV6USB2?  
(6) power, (4) USB  
List Price: \$870 per unit



Code: PCV6USB2V?  
(6) power, (4) USB, (1) AV Plate cut-out  
List Price: \$870 per unit

**LOCATION CODES ARE ON PAGE 6**

# COVE POWER – LINKING

Questions? Call 816-774-4050



Specs: The Cove Series is a flush mount. Choose from power only, power and USB charging, or power, USB charging, and AV plate cut-out configurations. Units are wired for two circuits and include metal flexible interconnecting cables that mount to the underside of the tops. Starter cable(s) are specified separately. Receptacles are spill resistant, 12A, 120 VAC. USB ports are 2.1 AMP. All table tops include cut-out(s) and are predrilled for units. Some assembly required. The Cove is ETL listed.

**? in the Code represents COLOR.**

**Replace ? with one of the following: B-Black, S-Silver, W-Gloss White.**

**Select the Location Code below for your power unit.**

**Select AV plates (if needed), AV plates can be found on page 8-9.**

**Select Type and # of Feeder Starter Cables required**



Code: PCVL1?  
(1) power  
List Price: \$485 per unit



Code: PCVL1USB?  
(1) power, (2) USB  
List Price: \$690 per unit



Code: PCVL2?  
(2) power  
List Price: \$550 per unit



Code: PCVL2USB?  
(2) power, (2) USB  
List Price: \$715 per unit



Code: PCVL2USBAB?  
(2) power, (2) USB, (1) AV plate cut-out  
List Price: \$715 per unit



Code: PCVL3?  
(3) Power  
List Price: \$745 per unit



Code: PCVL3USB?  
(3) power, (2) USB  
List Price: \$855 per unit



Code: PCVL3USBAB?  
(3) power, (2) USB, (1) AV Plate cut-out  
List Price: \$855 per unit

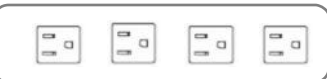

Code: PCVL4?  
(4) Power  
List Price: \$800 per unit



Code: PCVL4USB?  
(4) power, (2) USB  
List Price: \$965 per unit

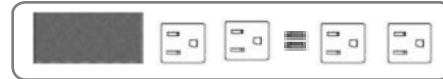

Code: PCVL4USBAB?  
(4) power, (2) USB, (1) AV Plate cut-out  
List Price: \$965 per unit

## SPEC SPARATELY HOW MANY FEEDER CABLES YOU NEED FOR YOUR LAYOUT



Code: PSTS72F - Soft wire 72" long List Price \$220 per cable  
Code: PSTS96F - Soft wire 96" long List Price \$300 per cable  
Code: PSTS108F - Soft wire 108" long List Price \$340 per cable  
Code: PSTS120F - Soft wire 120" long List Price \$350 per cable  
Code: PSTS144F - Soft wire 144" long List Price \$380 per cable



Code: PSTH72F - Hardwire 72" long List Price \$140 per cable  
Code: PSTH96F - Hardwire 96" long List Price \$170 per cable  
Code: PSTH108F - Hardwire 108" long List Price \$180 per cable  
Code: PSTH120F - Hardwire 120" long List Price \$195 per cable  
Code: PSTH144F - Hardwire 144" long List Price \$220 per cable

**LOCATION CODES ARE ON PAGE 6**

# VILLA POWER – NON LINKING

Questions? Call 816-774-4050



**Specs:** The Villa Series is a two part unit which is mounted below the surface and a flush mount grommet which is secured with screws. Grommets are available in black, silver, and gloss white. Units include 2 power outlets, 2 USB ports, 2 data jacks, and 2 charging ports, and data jacks. Units are wired for circuit one and include a 108" long soft wired 15 AMP cord. Units are spill resistant, 12A, 120 VAC, USB ports are 2.1 AMP and data jacks are Cat 6. Convenience outlets are located underneath units, additional outlets available on select units and are shown below. All table tops include cut-out(s) and are predrilled for units. Some assembly required. The Villa is ETL listed.

**AS OF 2021  
PRODUCT DISCONTINUED**

**? in the Code represents COLOR.**  
**Replace ? with one of the following: B-Black, S-Silver, W-Gloss White.**

**Select the Location Code below for your power unit.**

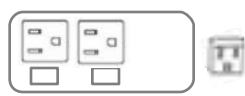

Code: PV?  
 (2) power, (2) data jack knockouts and  
 (1) outlet under the table  
 List Price: \$330 per unit



Code: PV1?  
 (2) power, (2) data jacks  
 (1) outlet under the table  
 List Price: \$470 per unit



Code: PVUSB?  
 (2) power, (2) USB, (2) data jack knockouts  
 (1) outlet under the table  
 List Price: \$495 per unit



Code: PV1USB?  
 (2) power, (2) USB, (2) data jacks  
 (1) outlet under the table  
 List Price: \$635 per unit



Code: PVP?  
 (2) power, (2) data jack knockouts  
 (3) outlets under the table  
 List Price: \$415 per unit



Code: PVP1?  
 (2) power, (2) data jacks  
 (3) outlets under the table  
 List Price: \$550 per unit



Code: PVPUSB?  
 (2) power, (2) USB, (2) data jack knockouts  
 (3) outlets under the table  
 List Price: \$580 per unit



Code: PVP1USB?  
 (2) power, (2) USB, (2) data jacks  
 (3) outlets under the table  
 List Price: \$650 per unit

**UNDER TABLE ONLY**

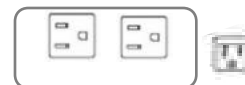

Code: PVUM2CB  
 (3) outlets under the table  
 List Price: \$260 per unit

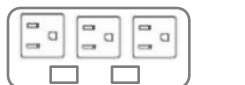

Code: PVUM3DB  
 (3) outlets under the table  
 (2) data jacks knockouts  
 List Price: \$305 per unit

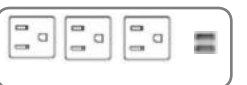

Code: PVUM3USBB  
 (3) outlets under the table  
 (2) USB under the table  
 List Price: \$440 per unit

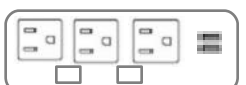

Code: PVUM3DUSBB  
 (3) outlets under the table  
 (2) USB under the table  
 (2) data jacks knockouts  
 List Price: \$470 per unit

**LOCATION CODES ARE ON PAGE 6**

# 5 VILLA POWER – LINKING

Questions? Call 816-774-4050



**Specs:** The Villa Series is a two part unit which is mounted below the surface and a flush mount grommet which is secured with screws. Grommets are available in black, silver, and gloss blend powder, USB charging ports, and data into a variety of applications. One or circuit 2 and include metal flexible connecting cables that neatly mount to the top. Screws and cable clamps are included, power starter cable(s) are specified separately. Receptacles are spill resistant, 12A, 120 VAC, USB ports are 2.1 AMP and data jacks are Cat 6. All table tops include cut-out(s) and are predrilled for units. Some assembly required. The Villa is ETL listed.

**AS OF 2021  
PRODUCT DISCONTINUED**

**? in the Code represents COLOR.**

**Replace ? with one of the following: B-Black, S-Silver, W-Gloss White.**

**Select the Location Code below for your power unit.**

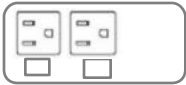

Code: PVL?  
(2) power, (2) data jack knockouts  
List Price: \$550 per unit



Code: PVL1?  
(2) power, (2) data jacks  
List Price: \$690 per unit



Code: PVLUSB?  
(2) power, (2) USB, (2) data jack knockouts  
List Price: \$715 per unit

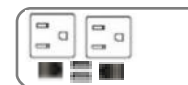

Code: PVL1USB?  
(2) power, (2) USB, (2) data jacks  
List Price: \$880 per unit



Code: PVPL?  
(2) power, (2) data jack knockouts  
(2) outlet under the table  
List Price: \$635 per unit



Code: PVPL1?  
(2) power, (2) data jacks  
(2) outlet under the table  
List Price: \$770 per unit



Code: PVPLUSB?  
(2) power, (2) USB, (1) data jack knockout  
(2) outlet under the table  
List Price: \$800 per unit



Code: PVPL1USB?  
(2) power, (2) USB, (1) data jack  
(2) outlet under the table  
List Price: \$870 per unit

## UNDER TABLE ONLY



Code: PVUMLB  
(2) power  
List Price: \$480 per unit

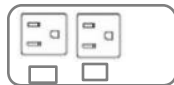

Code: PVUML1B  
(2) power, (2) data jack knockouts  
List Price: \$505 per unit

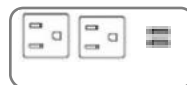

Code: PVUMLUSBB  
(2) power, (2) USB  
List Price: \$645 per unit

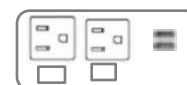

Code: PVUML1USBB  
(2) power, (2) USB, (2) data jack knockouts  
List Price: \$670 per unit

## SPEC SPARATELY HOW MANY FEEDER CABLES YOU NEED FOR YOUR LAYOUT



Code: PSTS72F - Soft wire 72" long List Price \$220 per cable  
Code: PSTS96F - Soft wire 96" long List Price \$300 per cable  
Code: PSTS108F - Soft wire 108" long List Price \$340 per cable  
Code: PSTS120F - Soft wire 120" long List Price \$350 per cable  
Code: PSTS144F - Soft wire 144" long List Price \$380 per cable



Code: PSTH72F - Hardwire 72" long List Price \$140 per cable  
Code: PSTH96F - Hardwire 96" long List Price \$170 per cable  
Code: PSTH108F - Hardwire 108" long List Price \$180 per cable  
Code: PSTH120F - Hardwire 120" long List Price \$195 per cable  
Code: PSTH144F - Hardwire 144" long List Price \$220 per cable

**LOCATION CODES ARE ON PAGE 6**

# SECLUSION POWER – NON - LINKING

Questions? Call 816-774-4050



Specs: The Seclusion Series is an edge mount unit. Choose from power only, power and USB charging, or power, USB charging, and AV plate cut-out configurations. Units are wired for circuit one and include a 72" long soft wired 15 AMP corded plug.

? in the Code represents COLOR.

Replace ? with one of the following: **B-Black, S-Silver, W-Gloss White.**

\* Premium Upcharge Colors for \$50 list per box are: **LG-Light Green, LB-Light Blue, SR-Signal Red, PO-Pure Orange, SY-Sulfur Yellow**

Select the Location Code below for your power unit.



Code: PSE2?  
(2) power  
List Price: \$290 per unit



Code: PSE1D?  
(1) power, (1) datajacks  
List Price: \$320 per unit



Code: PSE1USB?  
(1) power, (2) USB  
List Price: \$440 per unit



Code: PSE1USB AV?  
(1) power, (2) USB, (1) AV plate cut-out  
List Price: \$440 per unit

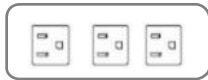

Code: PSE3?  
(3) power  
List Price: \$330 per unit



Code: PSE2D2?  
(2) power, (2) datajacks  
List Price: \$385 per unit



Code: PSE3USB?  
(3) power, (2) USB  
List Price: \$455 per unit

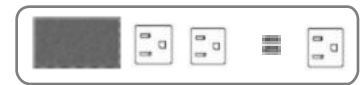

Code: PSE3USB AV?  
(3) power, (2) USB, (1) AV plate cut-out  
List Price: \$455 per unit

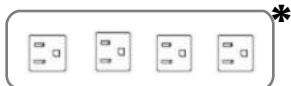

Code: PSE4?  
(4) Power  
List Price: \$375 per unit



Code: PSE3AV?  
(3) power, (1) AV plate cut-out  
List Price: \$400 per unit

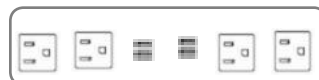

Code: PSE4USB2?  
(4) power, (4) USB  
List Price: \$635 per unit



Code: PSE4USB2 AV?  
(4) power, (4) USB, (1) AV plate cut-out  
List Price: \$635 per unit

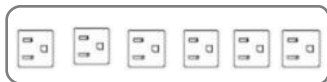

Code: PSE6?  
(6) Power  
List Price: \$445 per unit

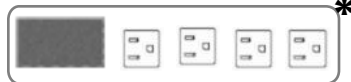

Code: PSE4AV?  
(4) power, (1) AV plate cut-out  
List Price: \$440 per unit



Code: PSE5USB?  
(5) power, (2) USB  
List Price: \$550 per unit

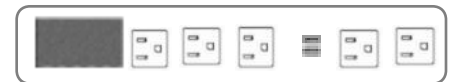

Code: PSE5USB AV?  
(5) power, (2) USB, (1) AV plate cut-out  
List Price: \$550 per unit

**LOCATION CODES ARE ON PAGE 6**

# SECLUSION POWER – LINKING

Questions? Call 816-774-4050

**AS OF 2021  
PRODUCT DISCONTINUED**

Specs: The Seclusion Series is an edge table with power and USB charging, or power, USB charging, and AV plates. They are wired for two circuits and include metal flexible interconnects on the underside of the tops. Starter cable(s) are specified separately.



**? in the Code represents COLOR.**  
Replace ? with one of the following: **B-Black, S-Silver**

**Select the Location Code below for your power unit.**  
**Select AV plates (if needed), AV plates can be found on page 8-9.**  
**Select Type and # of Feeder Starter Cables required**



Code: PSEL1D?  
(1) power, (1) data jacks  
List Price: \$665 per unit



Code: PSEL2D2?  
(2) power, (2) data jacks  
List Price: \$760 per unit



Code: PSEL2?  
(2) power  
List Price: \$665 per unit

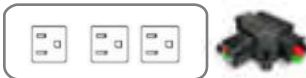

Code: PSEL3?  
(3) power  
List Price: \$705 per unit

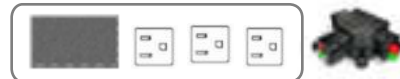

Code: PSEL3AV?  
(3) power, (1) AV plate cut-out  
List Price: \$790 per unit



Code: PSEL4?  
(4) Power  
List Price: \$750 per unit



Code: PSEL4AV?  
(4) power, (1) AV plate cut-out  
List Price: \$840 per unit

## SPEC SPARATELY HOW MANY FEEDER CABLES YOU NEED FOR YOUR LAYOUT



- Code: PSTS72F - Soft wire 72" long List Price \$220 per cable
- Code: PSTS96F - Soft wire 96" long List Price \$300 per cable
- Code: PSTS108F - Soft wire 108" long List Price \$340 per cable
- Code: PSTS120F - Soft wire 120" long List Price \$350 per cable
- Code: PSTS144F - Soft wire 144" long List Price \$380 per cable



- Code: PSTH72F - Hardwire 72" long List Price \$140 per cable
- Code: PSTH96F - Hardwire 96" long List Price \$170 per cable
- Code: PSTH108F - Hardwire 108" long List Price \$180 per cable
- Code: PSTH120F - Hardwire 120" long List Price \$195 per cable
- Code: PSTH144F - Hardwire 144" long List Price \$220 per cable

## LOCATION CODES ARE ON PAGE 6



# INTERACT G2 POWER - NON-LINKING

Questions? Call 816-774-4050



Specs: The Interact G2 Series is designed for small conference areas and meeting rooms. Choose from power or power and USB charging. Both options include (1) AV plate knock-out, (2) data/phone jack knockouts, (2) cord pass throughs and (1) convenience outlet located underneath for added utility power.

Units are wired for circuit one and include 72" hardwired or soft-wired power cords. All table tops include cut-out(s) and are predrilled for units. Some assembly required. The G2 is ETL listed.

**? in the Code represents COLOR.**

**Replace ? with one of the following: B-Black, S-Silver, W-Gloss White.**

**Select the Location Code below for your power unit.**

**Select AV plates (if needed), AV plates can be found on page 8-9.**

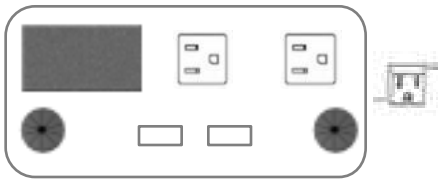

### SOFT-WIRED POWER

Code: PIG2S B/S/W

Includes (2) power, (1) AV plate cut-out, (2) data jack knockouts, (2) cord pass throughs, and (1) convenience outlet located on bottom of unit with 72" long soft-wired corded plug. Table tops include cut outs and are pre-drilled.

List Price: \$415 per unit

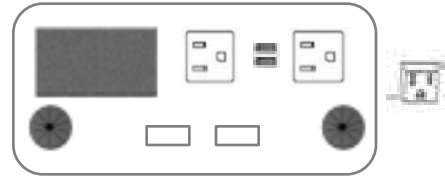

### SOFT-WIRED POWER/USB

Code: PIG2USBS B/S/W

Includes (2) power, (2) USB ports, (1) AV plate cut-out, (2) data jack knockouts, (2) cord pass throughs, and (1) convenience outlet located on bottom of unit with 72" long soft-wired corded plug. Table tops include cut outs and are pre-drilled.

List Price: \$580 per unit

### HARD-WIRED POWER

Code: PIG2H B/S/W

Includes (2) power, (1) AV plate cut-out, (2) data jack knockouts, (2) cord pass throughs, and (1) convenience outlet located on bottom of unit with 72" long hard-wired cord. Table tops include cut outs and are pre-drilled.

List Price: \$460 per unit

### HARD-WIRED POWER

Code: PIG2USBH B/S/W

Includes (2) power, (2) USB ports, (1) AV plate cut-out, (2) data jack knockouts, (2) cord pass throughs, and (1) convenience outlet located on bottom of unit with 72" long hard-wired cord. Table tops include cut outs and are pre-drilled.

List Price: \$635 per unit

**LOCATION CODES ARE ON PAGE 6**

# INTERFACE IITT POWER - NON-LINKING

Questions? Call 816-774-4050

**AS OF 2021  
PRODUCT DISCONTINUED**



Specs: The Interface IITT Series... convenience outlet located underneath... Units are wired for circuit one and include 108" long soft-wired... cords. Optional feeder cable lengths include 72", 144"... tops include cut-out(s) and are predrilled for units. Some assemblies...

**? in the Code represents COLOR.**

**Replace ? with one of the following: B-Black, S-Silver**

**Select the Location Code below for your power unit.**

**Select AV plates (if needed), AV plates can be found on page 8-9.**

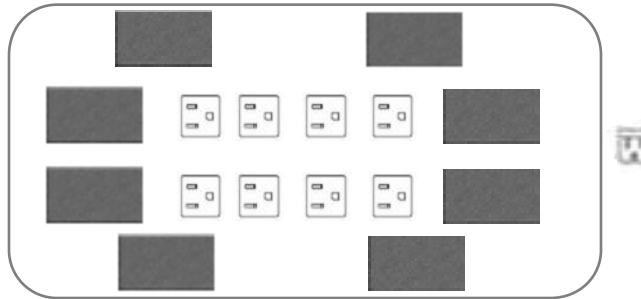

### SOFT-WIRED POWER

Code: PIN8S B/S

Includes (8) power, (8) AV plate cut-outs, and (1) convenience outlet located on bottom of unit with 108" long soft-wired corded plug. Table tops include cut outs and are pre-drilled.

List Price: \$1665 per unit

### HARD-WIRED POWER

Code: PIN8H B/S

Includes (8) power, (8) AV plate cut-out, and (1) convenience outlet located on bottom of unit with 108" long hard-wired corded plug. Table tops include cut outs and are pre-drilled.

List Price: \$1665 per unit

**LOCATION CODES ARE ON PAGE 6**

# REEF POWER - NON-LINKING AND LINKING

Questions? Call 816-774-4050

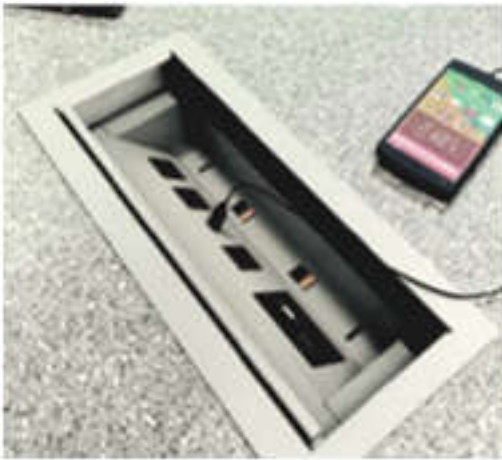

Specs: The Reef is a drop in table top units offering capabilities of combining power, USB, data, and additional AV options. It features a retractable lid. Receptacles are 12A, 120 VAC. USB ports are 2.1 AMP. Reef units include (2) data/phone jack knockouts. Data Jacks and AV Plates are specified separately. All table tops include cut-out(s) and are predrilled for units. Some assembly required. UL listed.

Reef non-linking units are wired for circuit one and feature a 108" soft-wire corded plug.

Linking units are wired two circuits and include metal flexible interconnecting cables that mount to the underside of the top.

## SPEC SPARATELY HOW MANY FEEDER CABLES YOU NEED FOR YOUR LAYOUT

? in the Code represents **COLOR**.

Replace ? with one of the following: **B-Black, S-Silver, W-Gloss White.**

Select the Location Code below for your power unit.

Select Data Jacks or AV plates (if needed), found on page 8-9.

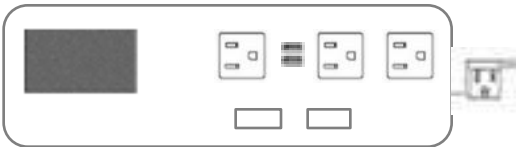

NON-LINKING

Code: PRF3USBAVC?

(3) Power, (2) USB, (1) AV Plate cut-out, (2) data jack knockouts (1) outlets under the table.

List Price: \$1240 per unit



NON-LINKING

Code: PRF4USBAV?

(4) Power, (2) USB, (1) AV Plate cut-out, and (2) data jack knockouts

List Price: \$1240 List



LINKING

Code: PRFL3USBAV?

(3) Power, (2) USB, (1) AV Plate cut-out, (2) data jack knockouts

List Price: \$1840 List

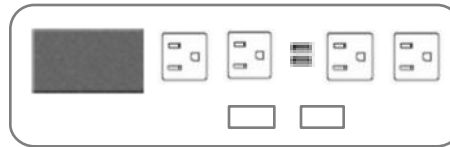

LINKING

Code: PRFL4USBAV?

(4) Power, (2) USB, (1) AV Plate cut-out, and (2) data jack knockouts

List Price: \$1840 List

## SPEC SPARATELY HOW MANY FEEDER CABLES YOU NEED FOR YOUR LAYOUT



- Code: PSTS72F - Soft wire 72" long List Price \$220 per cable
- Code: PSTS96F - Soft wire 96" long List Price \$300 per cable
- Code: PSTS108F - Soft wire 108" long List Price \$340 per cable
- Code: PSTS120F - Soft wire 120" long List Price \$350 per cable
- Code: PSTS144F - Soft wire 144" long List Price \$380 per cable



- Code: PSTH72F - Hardwire 72" long List Price \$140 per cable
- Code: PSTH96F - Hardwire 96" long List Price \$170 per cable
- Code: PSTH108F - Hardwire 108" long List Price \$180 per cable
- Code: PSTH120F - Hardwire 120" long List Price \$195 per cable
- Code: PSTH144F - Hardwire 144" long List Price \$220 per cable

**LOCATION CODES ARE ON PAGE 6**

# MINI - OASIS POWER - LINKING

Questions? Call 816-774-4050



Specs: The Mini-Oasis is a drop in table top units offering capabilities of combining power, USB, data, and additional AV options. It features two retractable lids.

Linking units are wired for two circuits and include metal flexible interconnecting cables that mount to the underside of the tops. Data Jacks and AV Plates are specified separately. All table tops include cut-out(s), and cover pan for the underside and are predrilled for units. Some assembly required. UL listed.

**SPEC SPARATELY HOW MANY FEEDER CABLES YOU NEED FOR YOUR LAYOUT**

**? in the Code represents COLOR.**

**Replace ? with one of the following: B-Black, S-Silver, W-Gloss White.**

**Select the Location Code below for your power unit.**

**Select Data Jacks or AV plates (if needed), found on page 8-9.**

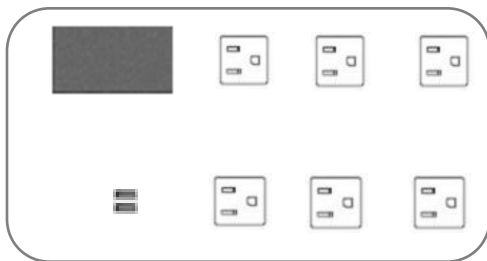

Code: PM L6USBAV?  
(6) Power, (2) USB, and (1) AV Plate cut-out.

List Price: \$2720 per unit

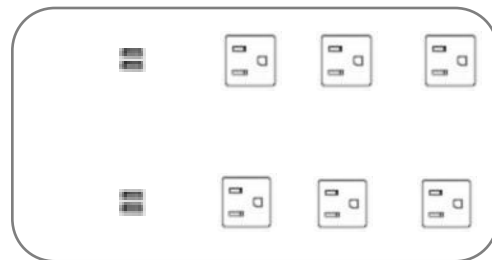

Code: PM L6USB2?  
(6) Power and (4) USB.

List Price: \$2910 per unit



Code: PM L6AV2?  
(6) Power and (2) AV Plate cut-outs.

List Price: \$2530 per unit



Code: PM L4AV3?  
(4) Power and (3) AV Plate cut-outs.

List Price: \$2530 per unit

## SPEC SPARATELY HOW MANY FEEDER CABLES YOU NEED FOR YOUR LAYOUT



- Code: PSTS72F - Soft wire 72" long List Price \$220 per cable
- Code: PSTS96F - Soft wire 96" long List Price \$300 per cable
- Code: PSTS108F - Soft wire 108" long List Price \$340 per cable
- Code: PSTS120F - Soft wire 120" long List Price \$350 per cable
- Code: PSTS144F - Soft wire 144" long List Price \$380 per cable



- Code: PSTH72F - Hardwired 72" long List Price \$140 per cable
- Code: PSTH96F - Hardwired 96" long List Price \$170 per cable
- Code: PSTH108F - Hardwired 108" long List Price \$180 per cable
- Code: PSTH120F - Hardwired 120" long List Price \$195 per cable
- Code: PSTH144F - Hardwired 144" long List Price \$220 per cable

**LOCATION CODES ARE ON PAGE 6**

## PERFORATED METAL MODESTY PANEL

9" High, 20 gauge steel with a durable powder coat finish. Available in black or silver. Modesty panels are free swinging on all tables. Not available on folding tables. Modesty panel and the underside of the table top are predrilled. Attachment Hardware and assembly instructions are included for field installation. Ganging plate and screws provided for tables longer than 72".

Model Code: MM??

30" table	\$185 list price	48" table	\$230 list price	For 84" tables spec two 42" panels	\$450 list price
36" table	\$190 list price	60" table	\$245 list price	For 96" tables spec two 48" panels	\$460 list price
42" table	\$225 list price	72" table	\$265 list price		

## LAMINATED MODESTY PANEL

9" High, .75" thick particle board. Finished with laminate both sides and all edges. Modesty panel and the underside of the table top are predrilled. Attachment Hardware and assembly instructions are included for field installation.

Model Code: ML??

30" table	\$210 list price	48" table	\$250 list price	For 84" tables spec two 42" panels	\$480 list price
36" table	\$230 list price	60" table	\$270 list price	For 96" tables spec two 48" panels	\$500 list price
42" table	\$240 list price	72" table	\$300 list price		

## VERTICAL ABS PLASTIC WIRE MANAGEMENT - ROUND

Half round shaped 2.68" x 1", combination of rigid and flexible PVC, vertical wire management. Heavy duty self-adhesive sticky tape is pre-installed on hinged edges of 22" long piece which allows track to conform easily to curved surface. Available in Black or Silver. Field Installed.

Model Code: WVB (black) or WVS (silver) \$25 list price per base

## VERTICAL ABS PLASTIC WIRE MANAGEMENT - RECTANGLE

Rectangle shaped 1" x 2", combination of rigid and flexible PVC, vertical wire management. Heavy duty self-adhesive sticky tape is pre-installed on hinged edges of 22" long piece which allows track to conform easily to surface. Available in Black or Silver. Field Installed.

Model Code: WRB (black) or WRS (silver) \$25 list price per base

## VERTICAL LASER CUT HOLE WIRE MANAGEMENT

1.5" x 2.5" holes cut in top and bottom of column to feed wire(s) in and out of base.

Model Code: WB \$50 list price per base

## HORIZONTAL WIRE MANAGEMENT TRACK

3" x .75" 4-channel wire management track, a co-extrusion with rigid sides and a softer top. Each channel is .75" x .625". In the center of each channel is a slot which has a memory, so it closes back up. Sold in 36" lengths, easily cut to desired length in the field. Features two strips of factory installed double sided tape on each 36" piece. Field Installed.

Model Code: WH \$80 list price per piece

## HORIZONTAL CONFERENCE WIRE MANAGEMENT TROUGH

12" wide x 34" long x 6" high 18 gage steel track, with eight 6" access holes, powder coated black.

Attachment hardware and installation instructions are included. Field installed.

Model Code: WT \$475 list price per trough

## METAL MODESTY PANEL WIRE MANAGEMENT J-CHANNEL

16 gage x 3.5" high x 2.37" deep horizontal J-Channel that hangs on free swinging perforated metal modesty panel. J-Channel simply clips into modesty panel slots, no hardware required. Sits 4.75" below bottom of top. Available in black or silver powder coat. Field Installed.

Model Code: WJ \$210 list price per piece

## ROUND WIRE MANAGEMENT GROMMET

2.5" round abs plastic grommet. Tables are drilled out at factory for correct hole size. Insert and cap ship loose and are easily installed, no hardware required. Field installed.

Model code: GS (silver) or GB (black) \$20 list price each



### CANYON WIRE MANAGEMENT

**AS OF 2021  
PRODUCT DISCONTINUED**

After wire management holes located 3" to center of hole to accommodate pass through of wire(s) from base to access door is 8" wide x 10" high and is located starting 2" from edge of hole. Door features a 1" x .75" finger pull and is attached with a hinge to allow easy access of wire(s) and floor receptacle. The 18" bases feature 12" openings in top and bottom and can accommodate up to a regular power box. The 24" bases feature 18" openings in top and bottom and can accommodate up to a Double power box or Mini Oasis.  
Model Code: ADCN \$300 list price per door for Canyon bases



**AS OF 2021  
PRODUCT DISCONTINUED**

18" x 3" wide rectangle 14 gage steel (\$300 list per base)  
Steel Wire Management Color: Any Hi5 standard powder coat



### TABLE GANGER

3.5" diameter 2-piece zinc die-cast table ganger. Simply twist and lock in place. See page 19 for possible configurations and location codes. Sold in sets, which consists of two gangers, four pieces. Attached with #10 x 3/4" screws. Factory installed.  
Not available on solid surface table tops or wood edged table tops.  
Not available on knife edge profiles.  
Model code: TG-LOCATION \$135 list price per set /table

### QUICK RELEASE PLATE

Constructed of 11 gage heavy duty steel, the 3" x 6" quick release plates are designed for supporting pie/quarter round shaped tops without a base or ganging larger tables. Simply loosen the hand knobs, slide tables together, tighten hand knobs and tops are joined level and secure. The low profile knob eliminates any conflict between the user and the release mechanism. Inserts are factory installed, plate and knobs are field installed. Plate has a black powder coat finish, knobs are rigid molded plastic.  
Available on solid surface table tops and wood edged table tops.  
Not available on knife edge profiles.  
Model Code: QR \$100 list price each plate

### MULTIPLE PIECE TABLES

Tables in multiple pieces require a field joint. Field joints have routed special shaped cut-outs on bottom of top and a grooved edge and use connector bolts and spline material to join tops together. Spline material is inserted into edge to guide and hold pieces together, the connector bolt is inserted into cut-out and tightened until seam is level and tight. Connector bolt is zinc plated, high carbon steel, 3.5" long, threaded about .75" of its length, with 1" cross pieces. Spline material is .125" hardboard cut in 1" widths and various lengths, dependent on table size. Field Installed.  
Model Code: FJ \$300 list price each additional joint on tables 10' and under.  
\*No Up-Charge, standard on tables longer than 10'

### FLAT PLATES

3" x 6", .125" thick fixed flat plates are used to provide additional leveling and support on multiple piece tops where there is no base support. Black powder coat finish. Plate, screws, and installation instructions are provided. Field installed.  
Model Code: FP \$20 list price each plate

### ANTI-SAG BARS

12 gage fabricated steel bar attached to underside of table top. 2" wide, black powder coat finish. Factory installed.  
Model code: AS \$100 list price each bar  
\*Standard on tower collection 60", 66", and 72" tables.

### CPU HOLDER - FIXED UNIT

Securely clamps and holds CPU, steel with black epoxy finish. Height adjustment of 13.375" - 20.5".



**AS OF 2021  
PRODUCT DISCONTINUED**

\$180 List Price Ea  
\$180 List Price Ea

Securely clamps and holds CPU, steel with black epoxy finish. Height adjustment of 13.375" - 20.5", 360 degrees of swivel and 8.5" of travel provide easy access to connections on the rear of CPU.

Model Code: C3 - Width adjustment of 5.5" - 9.25" \$290 List Price Ea  
Model Code: C4 - Width adjustment of 2.75" - 5.25" \$290 List Price Ea

### DIVIDER / PRIVACY PANELS



**AS OF 2021  
PRODUCT UPDATED  
See Hi5Furniture.com**

36" high and feature polished edges and through mount hardware. Assembly instructions are provided. Field Installed. Model Code:

Complete the divider panel model code. [ex. DPA36 - is for a 36" long

30" panel \$770 list price 80" panel \$1495 list price 84" panel \$2620 list price  
36" panel \$1025 list price 66" panel \$1550 list price 96" panel \$2625 list price  
42" panel \$1380 list price 72" panel \$1905 list price

### RADIUS CORNERS



Radius Corners are available in 1", 2", 3", 4" or 5" radius. Due to the limitations of some edge profiles, please consult the factory for edge profile and radius recommendations.

Model Code: RC? Contact Factory for pricing

### METAL TO METAL CONNECTION



A metal to metal connection is recommended for tables that are dis-assembled and assembled often as the particle board core may weaken and cause stability issues with the bases. 1/4-20 Brass inserts are factory installed and 1/4-20 x 3/4" screws are provided for field installation of bases. Inserts have fins on the outside diameter which provides higher pull-out resistance and prevents splintering and splitting. Model Code: TI

\$100 list price per table

### FOLDING TABLE LEG OVER LEG BRACKET



The bracket raises one of the legs of the table so that it will overlap the other leg and fold into the storage position. Aluminum construction, black anodized finish. Two pieces per table are required, (four when used with double T bases), Factory installed.

Tables are not horizontally stackable with riser brackets.

Standard on all folding tables requiring leg over leg application



**AS OF 2021  
PRODUCT UPDATED  
See Hi5Furniture.com**

\$90 list price (C or T leg) FRIT \$160 list price (TT leg)

Folding Table Cart for Rect angle Tables up to 30 x 72 tables; Flat stack folding table cart. Holds up to 30" wide tables. Dimensions are 74.5"L x 31.5"W x 38"H. Cart weighs 96 lbs. and is black powder coated steel. Each cart holds 4-8 tables. Factory recommends to add customer's own straps to keep tables secure. Model Code: FC-72RE \$2700 list price



**AS OF 2021  
PRODUCT UPDATED  
See Hi5Furniture.com**

Folding Table Cart for Rect angle Tables up to 30 x 96 tables; Flat stack folding table cart. Holds up to 30" wide tables. Dimensions are 105"L x 31.5"W x 38"H. Cart weighs 104 lbs. and is black powder coated steel. Each cart holds 4-8 tables. Factory recommends to add customer's own straps to keep tables secure. Model Code: FC-Rect \$2700 list price

Folding Table Cart for Round Tables up to 72" round; Edge stack folding table cart. Holds 48", 60" and 72" round folding tables. Overall dimensions are 38.5" wide x 32.75" length x 50" height. Cart weighs 56 lbs and is black powder coated steel. Each cart holds four-six tables. Factory recommends to add customer's own straps to keep tables secure. Model Code: FC-Round \$2500 list price



## PUSH BUTTON ADJUSTABLE HEIGHT

The push button adjustable height option is a spring-clip column that allows adjustments in 1" increments. Available in two different ranges and various collections. Available in the following collections: Gateway, Harbor, Liberty, Supreme, and Tower.

Table Height Range: 26" - 35"

C's, T's, and Post legs	Model Code :AHC1, AHT1, AHP1	List Price: \$160 each base
X-Base, Supreme only	Model Code: AHX1	List Price: \$220 each base
TI-Base, Supreme only	Model Code: AHTT	List Price: \$300 each base

Table Height Range: 29" - 42"

C's, T's, and Post legs	Model Code: AHBC1, AHBT1, AHBP1	List Price: \$220 each base
X-Base, Supreme only	Model Code: AHX1	List Price: \$280 each base
TI-Base, Supreme only	Model Code: AHTT	List Price: \$430 each base

## HAND CRANK ADJUSTABLE HEIGHT

Adjustment at the turn of the handle. Available in the Liberty and the Empire collections



Empire - Screw thread adjustment with infinite stop positions. Adjust with manual crank handle at a rate of 6-1/3 turns per inch (4mm pitch). Table height range of 9.5", 27.25" - 36.75". Handle slides under table when not in use. Maximum lifting load of 180 pounds for single column and 225 pounds for two columns, maximum of three (3) columns adjusted from one crank handle. Option for Locking Casters is available which adds 2" to starting height.

## PNEUMATIC ADJUSTABLE HEIGHT

Pneumatic adjustment with easy lever release. Available in the Empire Collection only.



Pneumatic cylinder assist with infinite stop positions with no-bounce cylinder stop. Steel roller glide system. Unintentional-release resistant lever with cable release. Table height range of 17.7", 27.25"h to 45"h. Range Lifting force of forty four (44) pounds standard. Additional lifting forces are available, Contact Factory for information. Available options include Flip-top and Locking Casters. Locking Casters add 2" to starting height.

## ELECTRIC ADJUSTABLE HEIGHT

Electric motor adjustment at the touch of a switch. Available in the Liberty and Empire collections



Empire - Infinite stop positions with adjustment speed of 1.97" per second (50mm/sec). Two table height ranges to choose from: 19.69" of range, 27.25"h to 46.94"h or 26" of range, 22.25"h to 48.25"h. Simple up and down buttons, control up to 12 columns from a single keypad. Maximum lifting force of 225 pounds for two columns. Options and accessories include: Built-in Keypad w/display, Built-in memory keypad with display, keypad cable extensions, motor cable extensions, Link Cables, and safety sensors.

## ROUND & SQUARE FLIP TOP NESTING MECHANISM

Construction consists of 11 gauge stamped steel - Used on 42" and 48" flip-top nesting tables. Tops are predrilled for mechanism, field installed.



No Upcharge-Standard

Note: 42" square is maximum size available in the Gateway Collection.

## DUAL FLIP TOP NESTING MECHANISM

Consists of two latch assemblies designed to latch table in setup position, lever arm designed to support top in flipped position. Latches and lever arm factory installed in recessed pockets in top. Mounting plates are 5" x 11" x .25" steel, Top and Base supports are two 5.5" wide aluminum extrusions, length dependent upon table size. Extrusions are finished with a black powder coat, latches and lever have a durable black epoxy finish to match.



No Upcharge-Standard on all dual flip top tables





HPL Top Self edges <b>Suffix L6</b>	HPL Top Wood edges <b>Suffix L20</b>	HPL Top Plywood edges <b>Suffix L17</b>	
HPL Top 3mm PVC <b>Suffix L3</b>	HPL Top Knife PVC <b>Suffix L11</b>	HPL Top Knife Wood <b>Suffix L33</b>	HPL Top Knife Plywood <b>Suffix L18</b>

**Pull selection:**

Replace the ? with the pull # to complete the model code. All credenzas have fully finished backs and 4" tall black or chrome round feet.

Size	Model Code	# of Doors	List Price	List Price	List Price
24 x 36 x 29h	C? 243629 L	2 door	\$4,765	\$4,895	\$5,515
24 x 36 x 34h	C? 243634 L	2 door	\$4,970	\$5,100	\$5,720
24 x 53 x 29h	C? 245329 L	3 door	\$6,040	\$6,200	\$6,770
24 x 53 x 34h	C? 245334 L	3 door	\$6,260	\$6,420	\$6,990
24 x 72 x 29h	C? 247229 L	4 door	\$7,625	\$7,835	\$8,315
24 x 72 x 34h	C? 247234 L	4 door	\$8,140	\$8,350	\$8,830

**CREDENZA OPTIONS:**

- Locking doors
- Custom Stain for wood edges or s
- Premium laminate upcharge
- AV Rack
- Louvered Panel
- Touch Latch

**MODEL CODE**

- LK,
- UCS
- UCL
- AVRACK
- CLP
- CTL

**LIST PRICE**

- \$200 per door
- \$600
- \$1850 per rack
- \$100 per panel
- \$115 per door

**CREDENZA PULL OPTIONS:**

- Pull #1 - Round Bar pull, steel, stainless steel look, .472" diameter x 8.189" tall.
- Pull #2 - Arched Bar pull, steel, dark oil-rubbed bronze, 6.02" tall.
- Pull #3 - Split Bar pull, zinc, polished chrome, 1.378" wide x 6.772" tall.
- Pull #4 - Square Bar pull, stainless steel, matte finish, .591" wide x 5.63" tall.
- Pull #5 - Flat Bar Pull, Zinc, silver aluminum finish, .315" tall x 6.693" wide
- Pull #6 - L-Shape extruded aluminum pull, silver matte anodized, .748" high x 6.614" wide.

**MODEL CODE**

- CD1
- CD2
- CD3
- CD4
- CD5
- CD6

**LIST PRICE**

- No Up-Charge
- No Up-Charge
- No Up-Charge
- No Up-Charge
- No Up-Charge
- No Up-Charge

**CREDENZA SPECS:**

**LOCKING CREDEZA DOORS** - Disc Tumbler Cam Locks are offered for credenza doors. 90 degree cam turn, key removable in locked on unlocked position. Two keys are provided and are keyed alike. Specify one lock for every two doors.

**LOUVERED PANEL** - 20" x 16" 18 gage steel louvered panel. Louvers are 3" wide and spaced 4" center to center horizontally and 2" bottom to bottom vertically. Powder coated finish.

**CREDENZA AV RACK** - Rotating slide-out AV equipment rack simplifies equipment installation in cabinet and shortens installation and service time. Detachable rack frame also allows for off-site integration. Overall dimensions are 24" h x 19.25" deep with usable space of 21" h x 19" deep and a weight capacity of 125 lbs. Features include: integral cable management, ball bearing slides, 90 degree rotation ability for equipment servicing, ability to lock in extended and rotated positions, lockable (with included hardware), and a black brushed anodized finish.



Pull #1

Pull #2

Pull #3

Pull #4

Pull #5

Pull #6



<u>Size</u>	<u>Model Code</u>	<u>List Price</u>
20w x 24l x 48h	L202448L	\$6185
20w x 36l x 48h	L203648L	\$7645

**LECTERN OPTIONS:**

- Flip up Shelf (specify left or right side)
- Locking Casters
- Custom Stain
- Premium laminate upcharge
- Round Grommets (black)
- Round Grommets (silver)

**MODEL CODE**

- FS (L/R)
- CS
- UCS
- UCL
- GB
- GS

**LIST PRICE**

- \$350
- \$250
- \$400
- 
- \$20 per grommet
- \$20 per grommet

**LECTERN SPECS:**

*LECTERN FLIP-UP SHELF* - 12"W x 15"D flip-up shelf. Shelf features multi-position 14 gage steel fold-away zinc plated bracket, and a .75" thick shelf that is finished to match lectern. Factory installed. Specify Left or Right side

*MOBILE LECTERN* - Add mobility to your lectern! Four 2.375" (60mm) black casters with silver caps on 2.375" x 2.375" steel swivel plates. Features two non-locking and two locking casters. Locking casters are located on user side of lectern for easy access. Load rating of 130 pounds per caster, factory installed.

*POWERED LECTERN* - Add Power to lectern - features Villa unit with two power receptacles, one data jack, one VGA jack, and one mini stereo. Removable inner shelf is notched to allow wires to pass through, a 2.5" wire management hole with black grommet is located on bottom fixed shelf to allow pass through of wires to power source.

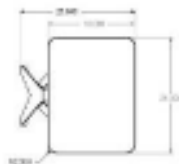

**NOTES & TIPS:**

Cast ered table comes with two locking and two non-locking casters.

Levelers lower overall height by .5"  
Casters raise overall height by .5"  
Arlington Heights are 1/8" Nominal

Weight Capacity:  
Levelers Edge Test = 275 lbs  
Levelers Center Test = 350 lbs

Caster Edge Test = 160 lbs  
Caster Center Test = 350 lbs

H x L x W	Top Shape	Function	Base Style	Model Code	Table List Price	Caster Upcharge Suffix -CS	Weight	Base Info
25" x 24 x 18	Soft Rectangle	Stationary	X	ANX1182425SRS.edge	\$950	+\$100	35lbs	Levelers
27" x 24 x 18	Soft Rectangle	Stationary	X	ANX1182427SRS.edge	\$950	+\$100	35lbs	Levelers
29" x 24 x 18	Soft Rectangle	Stationary	X	ANX1182429SRS.edge	\$950	+\$100	35lbs	Levelers
31" x 24 x 18	Soft Rectangle	Stationary	X	ANX1182431SRS.edge	\$950	+\$100	35lbs	Levelers

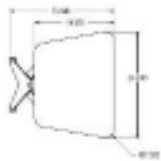

H x L x W	Top Shape	Function	Base Style	Model Code	Table List Price	Caster Upcharge	Weight	Base Info
25" x 24 x 18	Trapezoid	Stationary	X	ANX1182425STS.edge	\$950	+\$100	35lbs	Levelers
27" x 24 x 18	Trapezoid	Stationary	X	ANX1182427STS.edge	\$950	+\$100	35lbs	Levelers
29" x 24 x 18	Trapezoid	Stationary	X	ANX1182429STS.edge	\$950	+\$100	35lbs	Levelers
31" x 24 x 18	Trapezoid	Stationary	X	ANX1182431STS.edge	\$950	+\$100	35lbs	Levelers

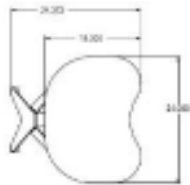

H x L x W	Top Shape	Function	Base Style	Model Code	Table List Price	Caster Upcharge	Weight	Base Info
25" x 24 x 18	Kidney	Stationary	X	ANX1182425KDS.edge	\$950	+\$100	35lbs	Levelers
27" x 24 x 18	Kidney	Stationary	X	ANX1182427KDS.edge	\$950	+\$100	35lbs	Levelers
29" x 24 x 18	Kidney	Stationary	X	ANX1182429KDS.edge	\$950	+\$100	35lbs	Levelers
31" x 24 x 18	Kidney	Stationary	X	ANX1182431KDS.edge	\$950	+\$100	35lbs	Levelers

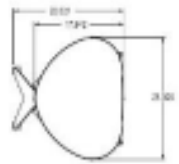

H x L x W	Top Shape	Function	Base Style	Model Code	Table List Price	Caster Upcharge	Weight	Base Info
25" x 24 x 18	Guitar Pick	Stationary	X	ANX1182425GPS.edge	\$950	+\$100	35lbs	Levelers
27" x 24 x 18	Guitar Pick	Stationary	X	ANX1182427GPS.edge	\$950	+\$100	35lbs	Levelers
29" x 24 x 18	Guitar Pick	Stationary	X	ANX1182429GPS.edge	\$950	+\$100	35lbs	Levelers
31" x 24 x 18	Guitar Pick	Stationary	X	ANX1182431GPS.edge	\$950	+\$100	35lbs	Levelers

# Coby Apron Base Placement Options

www.hi5furniture.com Questions? 816-774-4050

March 1, 2018

Up to 72" Long with 4 legs

- Can have
- No Foot Rail (CYA0)
- Centered Foot Rail (CYA1)
- Perimeter Foot Rail (CYA2)



84" to 108" Long with 4 legs

- Can have
- Centered Foot Rail (CYA1)
- Perimeter Foot Rail (CYA2)

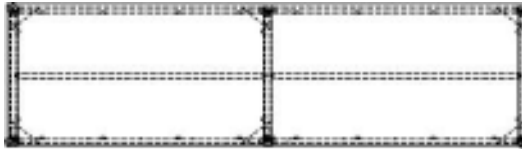

120" - 192 with 6 legs

- Can have
- Centered Foot Rail (CYA1)
- Perimeter Foot Rail (CYA2)

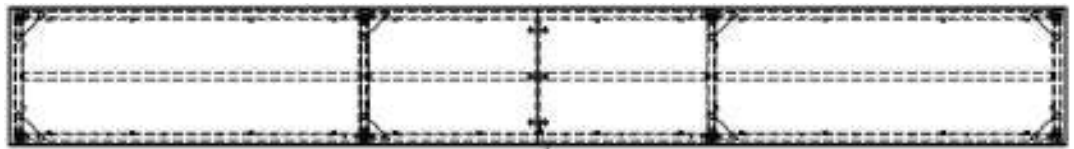

204" - 264" with 8 legs

- Can have
- Centered Foot Rail (CYA1)
- Perimeter Foot Rail (CYA2)

TOP WILL DRAW-BOLT TOGETHER

## SEATED HEIGHT

## CAFE HEIGHT

## BAR HEIGHT

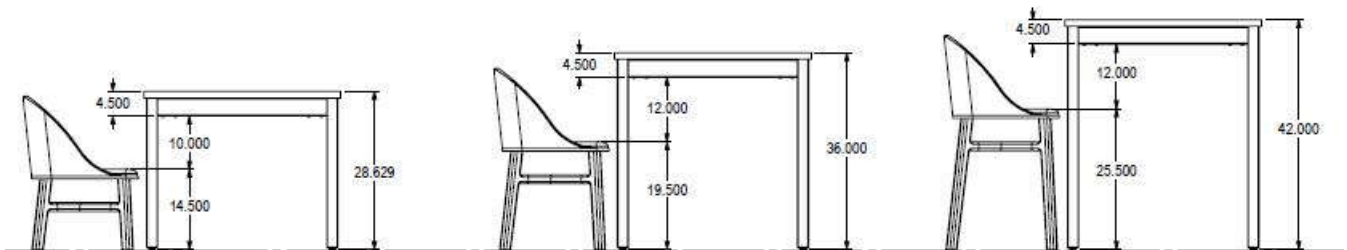

**NOTE: APRON AND TABLE TOP COMBINED ARE 4.5" HIGH**

29" SEATED HEIGHT TABLE HAS 24.5" OF CLEARANCE

36" SEATED HEIGHT TABLE HAS 31.5" OF CLEARANCE

42" SEATED HEIGHT TABLE HAS 37.5" OF CLEARANCE

IF BIFMA RECOMMENDED SPACE IS DESIRED, ORDER CUSTOM HEIGHT OF 32.5 FOR SEATED, 39.5" FOR CAFE AND 45.5" FOR BAR HEIGHT

## EDGE MOUNTED LOCATION CODES FOR POWER

Use these codes for mounting Cove power into aprons of Coby Apron tables. Also use these codes for Seclusion power boxes.

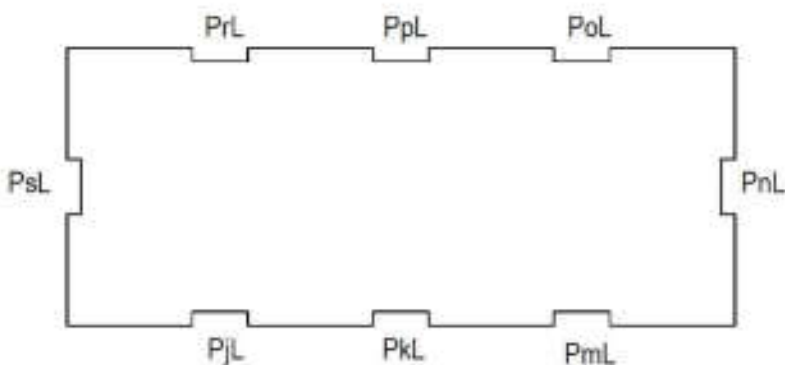

The example below location code is:  
PjL, PmL, PnL, PoL, PrL, PsL





**FINISHES NEEDED:** <http://hi5furniture.com/finishes/>

HPL Top: Hi5 Graded-in laminates or Non-Premium Wilsonart or Formica

Edge Color: Any Hi5 standard

Base Finish: Any Hi5 standard

NOTE: Raw Tube Steel with Clear Coat [RWT]

Coby Apron legs are tube steel, apron & foot rails are manufactured from sheet metal so Coby Apron bases will be two-toned if ordered in clear coat over raw steel



Table Size	Foot Rail Type	Model Code:	# of Pieces	# of Legs	List Price	List Price
18 x 18x 18" H	None	CYA0 181818SQS	1	4	\$1,840	\$1,840
18 x 18x 18" H	Centered	CYA1 181818SQS	1	4	\$2,515	\$2,515
18 x 18x 18" H	Perimeter	CYA2 181818SQS	1	4	\$2,740	\$2,740
18 x 18x 29" H	None	CYA0 181829SQS	1	4	\$1,880	\$1,880
18 x 18x 29" H	Centered	CYA1 181829SQS	1	4	\$2,555	\$2,555
18 x 18x 29" H	Perimeter	CYA2 181829SQS	1	4	\$2,780	\$2,780
18 x 18x 36" H	None	CYA0 181836SQS	1	4	\$2,000	\$2,000
18 x 18x 36" H	Centered	CYA1 181836SQS	1	4	\$2,675	\$2,675
18 x 18x 36" H	Perimeter	CYA2 181836SQS	1	4	\$2,900	\$2,900
18 x 18x 42" H	None	CYA0 181842SQS	1	4	\$2,060	\$2,060
18 x 18x 42" H	Centered	CYA1 181842SQS	1	4	\$2,735	\$2,735
18 x 18x 42" H	Perimeter	CYA2 181842SQS	1	4	\$2,960	\$2,960
24 x 24x 18" H	None	CYA0 242418SQS	1	4	\$2,180	\$2,180
24 x 24x 18" H	Centered	CYA1 242418SQS	1	4	\$2,915	\$2,915
24 x 24x 18" H	Perimeter	CYA2 242418SQS	1	4	\$3,160	\$3,160
24 x 24x 29" H	None	CYA0 242429SQS	1	4	\$2,220	\$2,220
24 x 24x 29" H	Centered	CYA1 242429SQS	1	4	\$2,955	\$2,955
24 x 24x 29" H	Perimeter	CYA2 242429SQS	1	4	\$3,200	\$3,200
24 x 24x 36" H	None	CYA0 242436SQS	1	4	\$2,340	\$2,340
24 x 24x 36" H	Centered	CYA1 242436SQS	1	4	\$3,075	\$3,075
24 x 24x 36" H	Perimeter	CYA2 242436SQS	1	4	\$3,320	\$3,320
24 x 24x 42" H	None	CYA0 242442SQS	1	4	\$2,400	\$2,400
24 x 24x 42" H	Centered	CYA1 242442SQS	1	4	\$3,135	\$3,135
24 x 24x 42" H	Perimeter	CYA2 242442SQS	1	4	\$3,380	\$3,380

POWER & A/V OPTIONS SEE PAGES 8-20

TABLE OPTIONS:

Laser cut holes in base - 1.5" x 2.5"

Locking Casters

Industrial Locking Casters

Paper Roll mounted to underside of table top

WB

CS

CS

ROLL

\$50 list for two bases

\$20 list per caster

\$70 list per caster

\$620 list per holder



**FINISHES NEEDED:** <http://hi5furniture.com/finishes/>

HPL Top: Hi5 Graded-in laminates or Non-Premium Wilsonart or Formica

Edge Color: Any Hi5 standard

Base Finish: Any Hi5 standard

NOTE: Raw Tube Steel with Clear Coat [RWT]

Coby Apron legs are tube steel, apron & foot rails are manufactured from sheet metal so Coby Apron bases will be two-toned if ordered in clear coat over raw steel



Table Size	Foot Rail Type	Model Code:	# of Pieces	# of Legs	List Price	List Price
30 x 30x 18" H	None	CYA0 303018SQS	1	4	\$2,260	\$2,260
30 x 30x 18" H	Centered	CYA1 303018SQS	1	4	\$3,010	\$3,010
30 x 30x 18" H	Perimeter	CYA2 303018SQS	1	4	\$3,260	\$3,260
30 x 30x 29" H	None	CYA0 303029SQS	1	4	\$2,300	\$2,220
30 x 30x 29" H	Centered	CYA1 303029SQS	1	4	\$3,050	\$3,050
30 x 30x 29" H	Perimeter	CYA2 303029SQS	1	4	\$3,300	\$3,300
30 x 30x 36" H	None	CYA0 303036SQS	1	4	\$2,420	\$2,420
30 x 30x 36" H	Centered	CYA1 303036SQS	1	4	\$3,170	\$3,170
30 x 30x 36" H	Perimeter	CYA2 303036SQS	1	4	\$3,420	\$3,420
30 x 30x 42" H	None	CYA0 303042SQS	1	4	\$2,480	\$2,480
30 x 30x 42" H	Centered	CYA1 303042SQS	1	4	\$3,230	\$3,230
30 x 30x 42" H	Perimeter	CYA2 303042SQS	1	4	\$3,480	\$3,480
36 x 36x 18" H	None	CYA0 363618SQS	1	4	\$2,320	\$2,320
36 x 36x 18" H	Centered	CYA1 363618SQS	1	4	\$3,295	\$3,295
36 x 36x 18" H	Perimeter	CYA2 363618SQS	1	4	\$3,620	\$3,620
36 x 36x 29" H	None	CYA0 363629SQS	1	4	\$2,360	\$2,360
36 x 36x 29" H	Centered	CYA1 363629SQS	1	4	\$3,335	\$3,335
36 x 36x 29" H	Perimeter	CYA2 363629SQS	1	4	\$3,660	\$3,660
36 x 36x 36" H	None	CYA0 363636SQS	1	4	\$2,480	\$2,480
36 x 36x 36" H	Centered	CYA1 363636SQS	1	4	\$3,455	\$3,455
36 x 36x 36" H	Perimeter	CYA2 363636SQS	1	4	\$3,780	\$3,780
36 x 36x 42" H	None	CYA0 363642SQS	1	4	\$2,540	\$2,540
36 x 36x 42" H	Centered	CYA1 363642SQS	1	4	\$3,515	\$3,515
36 x 36x 42" H	Perimeter	CYA2 363642SQS	1	4	\$3,840	\$3,840

POWER & A/V OPTIONS SEE PAGES 8-20

TABLE OPTIONS:

Laser cut holes in base - 1.5" x 2.5"

Locking Casters

Industrial Locking Casters

Paper Roll mounted to underside of table top

WB

CS

CS

ROLL

\$50 list for two bases

\$20 list per caster

\$70 list per caster

\$620 list per holder



**FINISHES NEEDED:** <http://hi5furniture.com/finishes/>

HPL Top: Hi5 Graded-in laminates or Non-Premium Wilsonart or Formica

Edge Color: Any Hi5 standard

Base Finish: Any Hi5 standard

NOTE: Raw Tube Steel with Clear Coat [RWT]

Coby Apron legs are tube steel, apron & foot rails are manufactured from sheet metal so Coby Apron bases will be two-toned if ordered in clear coat over raw steel



Table Size	Foot Rail Type	Model Code:	# of Pieces	# of Legs	List Price	List Price
42 x 42x 18" H	None	CYA0 424218SQS	1	4	\$2,420	\$2,420
42 x 42x 18" H	Centered	CYA1 424218SQS	1	4	\$3,440	\$3,440
42 x 42x 18" H	Perimeter	CYA2 424218SQS	1	4	\$3,780	\$3,780
42 x 42x 29" H	None	CYA0 424229SQS	1	4	\$2,460	\$2,460
42 x 42x 29" H	Centered	CYA1 424229SQS	1	4	\$3,480	\$3,480
42 x 42x 29" H	Perimeter	CYA2 424229SQS	1	4	\$3,820	\$3,820
42 x 42x 36" H	None	CYA0 424236SQS	1	4	\$2,580	\$2,580
42 x 42x 36" H	Centered	CYA1 424236SQS	1	4	\$3,600	\$3,600
42 x 42x 36" H	Perimeter	CYA2 424236SQS	1	4	\$3,940	\$3,940
42 x 42x 42" H	None	CYA0 424242SQS	1	4	\$2,640	\$2,640
42 x 42x 42" H	Centered	CYA1 424242SQS	1	4	\$3,660	\$3,660
42 x 42x 42" H	Perimeter	CYA2 424242SQS	1	4	\$4,000	\$4,000
48 x 48x 18" H	None	CYA0 484818SQS	1	4	\$2,500	\$2,500
48 x 48x 18" H	Centered	CYA1 484818SQS	1	4	\$3,625	\$3,625
48 x 48x 18" H	Perimeter	CYA2 484818SQS	1	4	\$4,000	\$4,000
48 x 48x 29" H	None	CYA0 484829SQS	1	4	\$2,540	\$2,540
48 x 48x 29" H	Centered	CYA1 484829SQS	1	4	\$3,665	\$3,665
48 x 48x 29" H	Perimeter	CYA2 484829SQS	1	4	\$4,040	\$4,040
48 x 48x 36" H	None	CYA0 484836SQS	1	4	\$2,660	\$2,660
48 x 48x 36" H	Centered	CYA1 484836SQS	1	4	\$3,785	\$3,785
48 x 48x 36" H	Perimeter	CYA2 484836SQS	1	4	\$4,160	\$4,160
48 x 48x 42" H	None	CYA0 484842SQS	1	4	\$2,720	\$2,720
48 x 48x 42" H	Centered	CYA1 484842SQS	1	4	\$3,845	\$3,845
48 x 48x 42" H	Perimeter	CYA2 484842SQS	1	4	\$4,220	\$4,220

POWER & A/V OPTIONS SEE PAGES 8-20

TABLE OPTIONS:

Laser cut holes in base - 1.5" x 2.5"

Locking Casters

Industrial Locking Casters

Paper Roll mounted to underside of table top

WB

CS

CS

ROLL

\$50 list for two bases

\$20 list per caster

\$70 list per caster

\$620 list per holder



**FINISHES NEEDED:** <http://hi5furniture.com/finishes/>

HPL Top: Hi5 Graded-in laminates or Non-Premium Wilsonart or Formica

Edge Color: Any Hi5 standard

Base Finish: Any Hi5 standard

NOTE: Raw Tube Steel with Clear Coat [RWT]

Coby Apron legs are tube steel, apron & foot rails are manufactured from sheet metal so Coby Apron bases will be two-toned if ordered in clear coat over raw steel



Table Size	Foot Rail Type	Model Code:	# of Pieces	# of Legs	List Price	List Price
60 x 60x 18" H	None	CYA0 606018SQS	1	4	\$2,560	\$2,560
60 x 60x 18" H	Centered	CYA1 606018SQS	1	4	\$3,970	\$3,970
60 x 60x 18" H	Perimeter	CYA2 606018SQS	1	4	\$4,440	\$4,440
60 x 60x 29" H	None	CYA0 606029SQS	1	4	\$2,600	\$2,600
60 x 60x 29" H	Centered	CYA1 606029SQS	1	4	\$4,010	\$4,010
60 x 60x 29" H	Perimeter	CYA2 606029SQS	1	4	\$4,480	\$4,480
60 x 60x 36" H	None	CYA0 606036SQS	1	4	\$2,720	\$2,720
60 x 60x 36" H	Centered	CYA1 606036SQS	1	4	\$4,130	\$4,130
60 x 60x 36" H	Perimeter	CYA2 606036SQS	1	4	\$4,600	\$4,600
60 x 60x 42" H	None	CYA0 606042SQS	1	4	\$2,780	\$2,780
60 x 60x 42" H	Centered	CYA1 606042SQS	1	4	\$4,190	\$4,190
60 x 60x 42" H	Perimeter	CYA2 606042SQS	1	4	\$4,660	\$4,660

POWER & A/V OPTIONS SEE PAGES 8-20

TABLE OPTIONS:

Laser cut holes in base - 1.5" x 2.5"

Locking Casters

Industrial Locking Casters

Paper Roll mounted to underside of table top

WB	\$50 list for two bases
CS	\$20 list per caster
CS	\$70 list per caster
ROLL	\$620 list per holder





**FINISHES NEEDED:** <http://hi5furniture.com/finishes/>

HPL Top: Hi5 Graded-in laminates or Non-Premium Wilsonart or Formica

Edge Color: Any Hi5 standard

Base Finish: Any Hi5 standard

NOTE: Raw Tube Steel with Clear Coat [RWT]

Coby Apron legs are tube steel, apron & foot rails are manufactured from sheet metal so Coby Apron bases will be two-toned if ordered in clear coat over raw steel



Table Size	Foot Rail Type	Model Code:	# of Pieces	# of Legs	List Price	List Price
18 x 36x 18" H	None	CYA0 183618RE S	1	4	\$2,470	\$2,590
18 x 36x 18" H	Centered	CYA1 183618RE S	1	4	\$3,245	\$3,365
18 x 36x 18" H	Perimeter	CYA2 183618RE S	1	4	\$3,570	\$3,690
18 x 36x 29" H	None	CYA0 183629RE S	1	4	\$2,510	\$2,630
18 x 36x 29" H	Centered	CYA1 183629RE S	1	4	\$3,285	\$3,405
18 x 36x 29" H	Perimeter	CYA2 183629RE S	1	4	\$3,610	\$3,730
18 x 36x 36" H	None	CYA0 183636RE S	1	4	\$2,630	\$2,750
18 x 36x 36" H	Centered	CYA1 183636RE S	1	4	\$3,405	\$3,525
18 x 36x 36" H	Perimeter	CYA2 183636RE S	1	4	\$3,730	\$3,850
18 x 36x 42" H	None	CYA0 183642RE S	1	4	\$2,690	\$2,810
18 x 36x 42" H	Centered	CYA1 183642RE S	1	4	\$3,465	\$3,585
18 x 36x 42" H	Perimeter	CYA2 183642RE S	1	4	\$3,790	\$3,910
18 x 42x 18" H	None	CYA0 184218RE S	1	4	\$2,570	\$2,705
18 x 42x 18" H	Centered	CYA1 184218RE S	1	4	\$3,360	\$3,495
18 x 42x 18" H	Perimeter	CYA2 184218RE S	1	4	\$3,700	\$3,835
18 x 42x 29" H	None	CYA0 184229RE S	1	4	\$2,610	\$2,745
18 x 42x 29" H	Centered	CYA1 184229RE S	1	4	\$3,400	\$3,535
18 x 42x 29" H	Perimeter	CYA2 184229RE S	1	4	\$3,740	\$3,875
18 x 42x 36" H	None	CYA0 184236RE S	1	4	\$2,730	\$2,865
18 x 42x 36" H	Centered	CYA1 184236RE S	1	4	\$3,520	\$3,655
18 x 42x 36" H	Perimeter	CYA2 184236RE S	1	4	\$3,860	\$3,995
18 x 42x 42" H	None	CYA0 184242RE S	1	4	\$2,790	\$2,925
18 x 42x 42" H	Centered	CYA1 184242RE S	1	4	\$3,580	\$3,715
18 x 42x 42" H	Perimeter	CYA2 184242RE S	1	4	\$3,920	\$4,055

POWER & A/V OPTIONS SEE PAGES 8-20

TABLE OPTIONS:

Laser cut holes in base - 1.5" x 2.5"

Locking Casters

Industrial Locking Casters

Paper Roll mounted to underside of table top

WB

CS

CS

ROLL

\$50 list for two bases

\$20 list per caster

\$70 list per caster

\$620 list per holder



**FINISHES NEEDED:** <http://hi5furniture.com/finishes/>

HPL Top: Hi5 Graded-in laminates or Non-Premium Wilsonart or Formica

Edge Color: Any Hi5 standard

Base Finish: Any Hi5 standard

NOTE: Raw Tube Steel with Clear Coat [RWT]

Coby Apron legs are tube steel, apron & foot rails are manufactured from sheet metal so Coby Apron bases will be two-toned if ordered in clear coat over raw steel



Table Size	Foot Rail Type	Model Code:	# of Pieces	# of Legs	List Price	List Price
18 x 48x 18" H	None	CYA0 184818RE S	1	4	\$2,610	\$2,745
18 x 48x 18" H	Centered	CYA1 184818RE S	1	4	\$3,435	\$3,570
18 x 48x 18" H	Perimeter	CYA2 184818RE S	1	4	\$3,810	\$3,945
18 x 48x 29" H	None	CYA0 184829RE S	1	4	\$2,650	\$2,785
18 x 48x 29" H	Centered	CYA1 184829RE S	1	4	\$3,475	\$3,610
18 x 48x 29" H	Perimeter	CYA2 184829RE S	1	4	\$3,850	\$3,985
18 x 48x 36" H	None	CYA0 184836RE S	1	4	\$2,770	\$2,905
18 x 48x 36" H	Centered	CYA1 184836RE S	1	4	\$3,595	\$3,730
18 x 48x 36" H	Perimeter	CYA2 184836RE S	1	4	\$3,970	\$4,105
18 x 48x 42" H	None	CYA0 184842RE S	1	4	\$2,830	\$2,965
18 x 48x 42" H	Centered	CYA1 184842RE S	1	4	\$3,655	\$3,790
18 x 48x 42" H	Perimeter	CYA2 184842RE S	1	4	\$4,030	\$4,165
18 x 60x 18" H	None	CYA0 186018RE S	1	4	\$2,690	\$2,840
18 x 60x 18" H	Centered	CYA1 186018RE S	1	4	\$3,610	\$3,760
18 x 60x 18" H	Perimeter	CYA2 186018RE S	1	4	\$4,080	\$4,230
18 x 60x 29" H	None	CYA0 186029RE S	1	4	\$2,730	\$2,880
18 x 60x 29" H	Centered	CYA1 186029RE S	1	4	\$3,650	\$3,800
18 x 60x 29" H	Perimeter	CYA2 186029RE S	1	4	\$4,120	\$4,270
18 x 60x 36" H	None	CYA0 186036RE S	1	4	\$2,850	\$3,000
18 x 60x 36" H	Centered	CYA1 186036RE S	1	4	\$3,770	\$3,920
18 x 60x 36" H	Perimeter	CYA2 186036RE S	1	4	\$4,240	\$4,390
18 x 60x 42" H	None	CYA0 186042RE S	1	4	\$2,910	\$3,060
18 x 60x 42" H	Centered	CYA1 186042RE S	1	4	\$3,830	\$3,980
18 x 60x 42" H	Perimeter	CYA2 186042RE S	1	4	\$4,300	\$4,450

POWER & A/V OPTIONS SEE PAGES 8-20

TABLE OPTIONS:

Laser cut holes in base - 1.5" x 2.5"

Locking Casters

Industrial Locking Casters

Paper Roll mounted to underside of table top

WB

CS

CS

ROLL

\$50 list for two bases

\$20 list per caster

\$70 list per caster

\$620 list per holder



**FINISHES NEEDED:** <http://hi5furniture.com/finishes/>

HPL Top: Hi5 Graded-in laminates or Non-Premium Wilsonart or Formica

Edge Color: Any Hi5 standard

Base Finish: Any Hi5 standard

NOTE: Raw Tube Steel with Clear Coat [RWT]

Coby Apron legs are tube steel, apron & foot rails are manufactured from sheet metal so Coby Apron bases will be two-toned if ordered in clear coat over raw steel



Table Size	Foot Rail Type	Model Code:	# of Pieces	# of Legs	List Price	List Price
18 x 72x 18" H	None	CYA0 187218RE S	1	4	\$2,860	\$3,050
18 x 72x 18" H	Centered	CYA1 187218RE S	1	4	\$4,025	\$4,215
18 x 72x 18" H	Perimeter	CYA2 187218RE S	1	4	\$4,740	\$4,930
18 x 72x 29" H	None	CYA0 187229RE S	1	4	\$2,900	\$3,090
18 x 72x 29" H	Centered	CYA1 187229RE S	1	4	\$4,065	\$4,255
18 x 72x 29" H	Perimeter	CYA2 187229RE S	1	4	\$4,780	\$4,970
18 x 72x 36" H	None	CYA0 187236RE S	1	4	\$3,020	\$3,210
18 x 72x 36" H	Centered	CYA1 187236RE S	1	4	\$4,185	\$4,375
18 x 72x 36" H	Perimeter	CYA2 187236RE S	1	4	\$4,900	\$5,090
18 x 72x 42" H	None	CYA0 183722RE S	1	4	\$3,080	\$3,270
18 x 72x 42" H	Centered	CYA1 183722RE S	1	4	\$4,245	\$4,435
18 x 72x 42" H	Perimeter	CYA2 183722RE S	1	4	\$4,960	\$5,150
18 x 84x 29" H	Centered	CYA1 188429RE S	1	4	\$4,185	\$4,405
18 x 84x 29" H	Perimeter	CYA2 188429RE S	1	4	\$4,910	\$5,130
18 x 84x 36" H	Centered	CYA1 188436RE S	1	4	\$4,305	\$4,525
18 x 84x 36" H	Perimeter	CYA2 188436RE S	1	4	\$5,030	\$5,250
18 x 84x 42" H	Centered	CYA1 188442RE S	1	4	\$4,365	\$4,585
18 x 84x 42" H	Perimeter	CYA2 188442RE S	1	4	\$5,090	\$5,310
18 x 96x 29" H	Centered	CYA1 189629RE S	1	4	\$4,225	\$4,450
18 x 96x 29" H	Perimeter	CYA2 189629RE S	1	4	\$4,960	\$5,185
18 x 96x 36" H	Centered	CYA1 189636RE S	1	4	\$4,275	\$4,500
18 x 96x 36" H	Perimeter	CYA2 189636RE S	1	4	\$5,080	\$5,305
18 x 96x 42" H	Centered	CYA1 189642RE S	1	4	\$4,405	\$4,630
18 x 96x 42" H	Perimeter	CYA2 189642RE S	1	4	\$5,140	\$5,365

POWER & A/V OPTIONS SEE PAGES 8-20

TABLE OPTIONS:

Laser cut holes in base - 1.5" x 2.5"

Locking Casters

Industrial Locking Casters

Paper Roll mounted to underside of table top

WB

CS

CS

ROLL

\$50 list for two bases

\$20 list per caster

\$70 list per caster

\$620 list per holder



**FINISHES NEEDED:** <http://hi5furniture.com/finishes/>

HPL Top: Hi5 Graded-in laminates or Non-Premium Wilsonart or Formica

Edge Color: Any Hi5 standard

Base Finish: Any Hi5 standard

NOTE: Raw Tube Steel with Clear Coat [RWT]

Coby Apron legs are tube steel, apron & foot rails are manufactured from sheet metal so Coby Apron bases will be two-toned if ordered in clear coat over raw steel



Table Size	Foot Rail Type	Model Code:	# of Pieces	# of Legs	List Price	List Price
18 x 120x 29" H	Centered	CYA1 1812029RE S	1	6	\$6,395	\$6,850
18 x 120x 29" H	Perimeter	CYA2 1812029RE S	1	6	\$7,335	\$7,790
18 x 120x 36" H	Centered	CYA1 1812036RE S	1	6	\$6,575	\$7,030
18 x 120x 36" H	Perimeter	CYA2 1812036RE S	1	6	\$7,515	\$7,970
18 x 120x 42" H	Centered	CYA1 1812042RE S	1	6	\$6,665	\$7,120
18 x 120x 42" H	Perimeter	CYA2 1812042RE S	1	6	\$7,605	\$8,060
18 x 144x 29" H	Centered	CYA1 1814429RE S	2	6	\$7,875	\$8,795
18 x 144x 29" H	Perimeter	CYA2 1814429RE S	2	6	\$9,305	\$10,225
18 x 144x 36" H	Centered	CYA1 1814436RE S	2	6	\$8,055	\$8,975
18 x 144x 36" H	Perimeter	CYA2 1814436RE S	2	6	\$9,485	\$10,405
18 x 144x 42" H	Centered	CYA1 1814442RE S	2	6	\$8,145	\$9,065
18 x 144x 42" H	Perimeter	CYA2 1814442RE S	2	6	\$9,575	\$10,495
18 x 168x 29" H	Centered	CYA1 1816829RE S	2	6	\$8,085	\$9,090
18 x 168x 29" H	Perimeter	CYA2 1816829RE S	2	6	\$9,535	\$10,540
18 x 168x 36" H	Centered	CYA1 1816836RE S	2	6	\$8,265	\$9,270
18 x 168x 36" H	Perimeter	CYA2 1816836RE S	2	6	\$9,715	\$10,720
18 x 168x 42" H	Centered	CYA1 1816842RE S	2	6	\$8,355	\$9,360
18 x 168x 42" H	Perimeter	CYA2 1816842RE S	2	6	\$9,805	\$10,810

POWER & A/V OPTIONS SEE PAGES 8-20

TABLE OPTIONS:

Laser cut holes in base - 1.5" x 2.5"

Locking Casters

Industrial Locking Casters

Paper Roll mounted to underside of table top

WB	\$50 list for two bases
CS	\$20 list per caster
CS	\$70 list per caster
ROLL	\$620 list per holder



**FINISHES NEEDED:** <http://hi5furniture.com/finishes/>

HPL Top: Hi5 Graded-in laminates or Non-Premium Wilsonart or Formica

Edge Color: Any Hi5 standard

Base Finish: Any Hi5 standard

NOTE: Raw Tube Steel with Clear Coat [RWT]

Coby Apron legs are tube steel, apron & foot rails are manufactured from sheet metal so Coby Apron bases will be two-toned if ordered in clear coat over raw steel



Table Size	Foot Rail Type	Model Code:	# of Pieces	# of Legs	List Price	List Price
18 x 192x 29" H	Centered	CYA1 1819229RE S	2	6	\$8,145	\$9,160
18 x 192x 29" H	Perimeter	CYA2 1819229RE S	2	6	\$9,615	\$10,630
18 x 192x 36" H	Centered	CYA1 1819236RE S	2	6	\$8,325	\$9,340
18 x 192x 36" H	Perimeter	CYA2 1819236RE S	2	6	\$9,795	\$10,810
18 x 192x 42" H	Centered	CYA1 1819242RE S	2	6	\$8,415	\$9,430
18 x 192x 42" H	Perimeter	CYA2 1819242RE S	2	6	\$9,885	\$10,900
18 x 240x 29" H	Centered	CYA1 1824029RE S	2	8	\$10,865	\$11,980
18 x 240x 29" H	Perimeter	CYA2 1824029RE S	2	8	\$13,010	\$14,125
18 x 240x 36" H	Centered	CYA1 1824036RE S	2	8	\$11,105	\$12,220
18 x 240x 36" H	Perimeter	CYA2 1824036RE S	2	8	\$13,250	\$14,365
18 x 240x 42" H	Centered	CYA1 1824042RE S	2	8	\$11,225	\$12,340
18 x 240x 42" H	Perimeter	CYA2 1824042RE S	2	8	\$13,370	\$14,485

POWER & A/V OPTIONS SEE PAGES 8-20

TABLE OPTIONS:

Laser cut holes in base - 1.5" x 2.5"

Locking Casters

Industrial Locking Casters

Paper Roll mounted to underside of table top

WB	\$50 list for two bases
CS	\$20 list per caster
CS	\$70 list per caster
ROLL	\$620 list per holder



**FINISHES NEEDED:** <http://hi5furniture.com/finishes/>

HPL Top: Hi5 Graded-in laminates or Non-Premium Wilsonart or Formica

Edge Color: Any Hi5 standard

Base Finish: Any Hi5 standard

NOTE: Raw Tube Steel with Clear Coat [RWT]

Coby Apron legs are tube steel, apron & foot rails are manufactured from sheet metal so Coby Apron bases will be two-toned if ordered in clear coat over raw steel



Table Size	Foot Rail Type	Model Code:	# of Pieces	# of Legs	List Price	List Price
24 x 36x 18" H	None	CYA0 243618RE S	1	4	\$2,670	\$2,800
24 x 36x 18" H	Centered	CYA1 243618RE S	1	4	\$3,485	\$3,615
24 x 36x 18" H	Perimeter	CYA2 243618RE S	1	4	\$3,810	\$3,940
24 x 36x 29" H	None	CYA0 243629RE S	1	4	\$2,710	\$2,840
24 x 36x 29" H	Centered	CYA1 243629RE S	1	4	\$3,525	\$3,655
24 x 36x 29" H	Perimeter	CYA2 243629RE S	1	4	\$3,850	\$3,980
24 x 36x 36" H	None	CYA0 243636RE S	1	4	\$2,830	\$2,960
24 x 36x 36" H	Centered	CYA1 243636RE S	1	4	\$3,645	\$3,775
24 x 36x 36" H	Perimeter	CYA2 243636RE S	1	4	\$3,970	\$4,100
24 x 36x 42" H	None	CYA0 243642RE S	1	4	\$2,890	\$3,020
24 x 36x 42" H	Centered	CYA1 243642RE S	1	4	\$3,705	\$3,835
24 x 36x 42" H	Perimeter	CYA2 243642RE S	1	4	\$4,030	\$4,160
24 x 42x 18" H	None	CYA0 244218RE S	1	4	\$2,770	\$2,915
24 x 42x 18" H	Centered	CYA1 244218RE S	1	4	\$3,600	\$3,745
24 x 42x 18" H	Perimeter	CYA2 244218RE S	1	4	\$3,940	\$4,085
24 x 42x 29" H	None	CYA0 244229RE S	1	4	\$2,810	\$2,955
24 x 42x 29" H	Centered	CYA1 244229RE S	1	4	\$3,640	\$3,785
24 x 42x 29" H	Perimeter	CYA2 244229RE S	1	4	\$3,980	\$4,125
24 x 42x 36" H	None	CYA0 244236RE S	1	4	\$2,930	\$3,075
24 x 42x 36" H	Centered	CYA1 244236RE S	1	4	\$3,760	\$3,905
24 x 42x 36" H	Perimeter	CYA2 244236RE S	1	4	\$4,100	\$4,245
24 x 42x 42" H	None	CYA0 244242RE S	1	4	\$2,990	\$3,135
24 x 42x 42" H	Centered	CYA1 244242RE S	1	4	\$3,820	\$3,965
24 x 42x 42" H	Perimeter	CYA2 244242RE S	1	4	\$4,160	\$4,305

POWER & A/V OPTIONS SEE PAGES 8-20

TABLE OPTIONS:

Laser cut holes in base - 1.5" x 2.5"

Locking Casters

Industrial Locking Casters

Paper Roll mounted to underside of table top

WB

CS

CS

ROLL

\$50 list for two bases

\$20 list per caster

\$70 list per caster

\$620 list per holder



**FINISHES NEEDED:** <http://hi5furniture.com/finishes/>

HPL Top: Hi5 Graded-in laminates or Non-Premium Wilsonart or Formica

Edge Color: Any Hi5 standard

Base Finish: Any Hi5 standard

NOTE: Raw Tube Steel with Clear Coat [RWT]

Coby Apron legs are tube steel, apron & foot rails are manufactured from sheet metal so Coby Apron bases will be two-toned if ordered in clear coat over raw steel



Table Size	Foot Rail Type	Model Code:	# of Pieces	# of Legs	List Price	List Price
24 x 48x 18" H	None	CYA0 244818RE S	1	4	\$2,820	\$2,965
24 x 48x 18" H	Centered	CYA1 244818RE S	1	4	\$3,685	\$3,830
24 x 48x 18" H	Perimeter	CYA2 244818RE S	1	4	\$4,060	\$4,205
24 x 48x 29" H	None	CYA0 244829RE S	1	4	\$2,860	\$3,005
24 x 48x 29" H	Centered	CYA1 244829RE S	1	4	\$3,725	\$3,870
24 x 48x 29" H	Perimeter	CYA2 244829RE S	1	4	\$4,100	\$4,245
24 x 48x 36" H	None	CYA0 244836RE S	1	4	\$2,980	\$3,125
24 x 48x 36" H	Centered	CYA1 244836RE S	1	4	\$3,845	\$3,990
24 x 48x 36" H	Perimeter	CYA2 244836RE S	1	4	\$4,220	\$4,365
24 x 48x 42" H	None	CYA0 244842RE S	1	4	\$3,040	\$3,185
24 x 48x 42" H	Centered	CYA1 244842RE S	1	4	\$3,905	\$4,050
24 x 48x 42" H	Perimeter	CYA2 244842RE S	1	4	\$4,280	\$4,425
24 x 60x 18" H	None	CYA0 246018RE S	1	4	\$2,900	\$3,060
24 x 60x 18" H	Centered	CYA1 246018RE S	1	4	\$3,860	\$4,020
24 x 60x 18" H	Perimeter	CYA2 246018RE S	1	4	\$4,330	\$4,490
24 x 60x 29" H	None	CYA0 246029RE S	1	4	\$2,940	\$3,100
24 x 60x 29" H	Centered	CYA1 246029RE S	1	4	\$3,900	\$4,060
24 x 60x 29" H	Perimeter	CYA2 246029RE S	1	4	\$4,370	\$4,530
24 x 60x 36" H	None	CYA0 246036RE S	1	4	\$3,060	\$3,220
24 x 60x 36" H	Centered	CYA1 246036RE S	1	4	\$4,020	\$4,180
24 x 60x 36" H	Perimeter	CYA2 246036RE S	1	4	\$4,490	\$4,650
24 x 60x 42" H	None	CYA0 246042RE S	1	4	\$3,120	\$3,280
24 x 60x 42" H	Centered	CYA1 246042RE S	1	4	\$4,080	\$4,240
24 x 60x 42" H	Perimeter	CYA2 246042RE S	1	4	\$4,550	\$4,710

POWER & A/V OPTIONS SEE PAGES 8-20

TABLE OPTIONS:

Laser cut holes in base - 1.5" x 2.5"

Locking Casters

Industrial Locking Casters

Paper Roll mounted to underside of table top

WB

CS

CS

ROLL

\$50 list for two bases

\$20 list per caster

\$70 list per caster

\$620 list per holder



**FINISHES NEEDED:** <http://hi5furniture.com/finishes/>

HPL Top: Hi5 Graded-in laminates or Non-Premium Wilsonart or Formica

Edge Color: Any Hi5 standard

Base Finish: Any Hi5 standard

NOTE: Raw Tube Steel with Clear Coat [RWT]

Coby Apron legs are tube steel, apron & foot rails are manufactured from sheet metal so Coby Apron bases will be two-toned if ordered in clear coat over raw steel



Table Size	Foot Rail Type	Model Code:	# of Pieces	# of Legs	List Price	List Price
24 x 72x 18" H	None	CYA0 247218RE S	1	4	\$3,100	\$3,310
24 x 72x 18" H	Centered	CYA1 247218RE S	1	4	\$4,305	\$4,515
24 x 72x 18" H	Perimeter	CYA2 247218RE S	1	4	\$5,020	\$5,230
24 x 72x 29" H	None	CYA0 247229RE S	1	4	\$3,140	\$3,350
24 x 72x 29" H	Centered	CYA1 247229RE S	1	4	\$4,345	\$4,555
24 x 72x 29" H	Perimeter	CYA2 247229RE S	1	4	\$5,060	\$5,270
24 x 72x 36" H	None	CYA0 247236RE S	1	4	\$3,260	\$3,470
24 x 72x 36" H	Centered	CYA1 247236RE S	1	4	\$4,465	\$4,675
24 x 72x 36" H	Perimeter	CYA2 247236RE S	1	4	\$5,180	\$5,390
24 x 72x 42" H	None	CYA0 243722RE S	1	4	\$3,320	\$3,530
24 x 72x 42" H	Centered	CYA1 243722RE S	1	4	\$4,525	\$4,735
24 x 72x 42" H	Perimeter	CYA2 243722RE S	1	4	\$5,240	\$5,450
24 x 84x 29" H	Centered	CYA1 248429RE S	1	4	\$4,465	\$4,705
24 x 84x 29" H	Perimeter	CYA2 248429RE S	1	4	\$5,190	\$5,430
24 x 84x 36" H	Centered	CYA1 248436RE S	1	4	\$4,585	\$4,825
24 x 84x 36" H	Perimeter	CYA2 248436RE S	1	4	\$5,310	\$5,550
24 x 84x 42" H	Centered	CYA1 248442RE S	1	4	\$4,645	\$4,885
24 x 84x 42" H	Perimeter	CYA2 248442RE S	1	4	\$5,370	\$5,610
24 x 96x 29" H	Centered	CYA1 249629RE S	1	4	\$4,495	\$4,740
24 x 96x 29" H	Perimeter	CYA2 249629RE S	1	4	\$5,230	\$5,475
24 x 96x 36" H	Centered	CYA1 249636RE S	1	4	\$4,545	\$4,790
24 x 96x 36" H	Perimeter	CYA2 249636RE S	1	4	\$5,350	\$5,595
24 x 96x 42" H	Centered	CYA1 249642RE S	1	4	\$4,675	\$4,920
24 x 96x 42" H	Perimeter	CYA2 249642RE S	1	4	\$5,410	\$5,655

POWER & A/V OPTIONS SEE PAGES 8-20

TABLE OPTIONS:

Laser cut holes in base - 1.5" x 2.5"

Locking Casters

Industrial Locking Casters

Paper Roll mounted to underside of table top

WB

CS

CS

ROLL

\$50 list for two bases

\$20 list per caster

\$70 list per caster

\$620 list per holder





**FINISHES NEEDED:** <http://hi5furniture.com/finishes/>

HPL Top: Hi5 Graded-in laminates or Non-Premium Wilsonart or Formica

Edge Color: Any Hi5 standard

Base Finish: Any Hi5 standard

NOTE: Raw Tube Steel with Clear Coat [RWT]

Coby Apron legs are tube steel, apron & foot rails are manufactured from sheet metal so Coby Apron bases will be two-toned if ordered in clear coat over raw steel



Table Size	Foot Rail Type	Model Code:	# of Pieces	# of Legs	List Price	List Price
24 x 120x 29" H	Centered	CYA1 2412029RE S	1	6	\$6,490	\$6,700
24 x 120x 29" H	Perimeter	CYA2 2412029RE S	1	6	\$7,680	\$8,150
24 x 120x 36" H	Centered	CYA1 2412036RE S	1	6	\$6,920	\$7,390
24 x 120x 36" H	Perimeter	CYA2 2412036RE S	1	6	\$7,860	\$8,330
24 x 120x 42" H	Centered	CYA1 2412042RE S	1	6	\$7,010	\$7,480
24 x 120x 42" H	Perimeter	CYA2 2412042RE S	1	6	\$7,950	\$8,420
24 x 144x 29" H	Centered	CYA1 2414429RE S	2	6	\$8,290	\$9,260
24 x 144x 29" H	Perimeter	CYA2 2414429RE S	2	6	\$9,720	\$10,690
24 x 144x 36" H	Centered	CYA1 2414436RE S	2	6	\$8,470	\$9,440
24 x 144x 36" H	Perimeter	CYA2 2414436RE S	2	6	\$9,900	\$10,870
24 x 144x 42" H	Centered	CYA1 2414442RE S	2	6	\$8,560	\$9,530
24 x 144x 42" H	Perimeter	CYA2 2414442RE S	2	6	\$9,990	\$10,960
24 x 168x 29" H	Centered	CYA1 2416829RE S	2	6	\$8,530	\$9,600
24 x 168x 29" H	Perimeter	CYA2 2416829RE S	2	6	\$9,980	\$11,050
24 x 168x 36" H	Centered	CYA1 2416836RE S	2	6	\$8,710	\$9,780
24 x 168x 36" H	Perimeter	CYA2 2416836RE S	2	6	\$10,160	\$11,230
24 x 168x 42" H	Centered	CYA1 2416842RE S	2	6	\$8,800	\$9,870
24 x 168x 42" H	Perimeter	CYA2 2416842RE S	2	6	\$10,250	\$11,320

POWER & A/V OPTIONS SEE PAGES 8-20

TABLE OPTIONS:

Laser cut holes in base - 1.5" x 2.5"

Locking Casters

Industrial Locking Casters

Paper Roll mounted to underside of table top

WB

CS

CS

ROLL

\$50 list for two bases

\$20 list per caster

\$70 list per caster

\$620 list per holder



**FINISHES NEEDED:** <http://hi5furniture.com/finishes/>

HPL Top: Hi5 Graded-in laminates or Non-Premium Wilsonart or Formica

Edge Color: Any Hi5 standard

Base Finish: Any Hi5 standard

NOTE: Raw Tube Steel with Clear Coat [RWT]

Coby Apron legs are tube steel, apron & foot rails are manufactured from sheet metal so Coby Apron bases will be two-toned if ordered in clear coat over raw steel



Table Size	Foot Rail Type	Model Code:	# of Pieces	# of Legs	List Price	List Price
24 x 192x 29" H	Centered	CYA1 2419229RE S	2	6	\$8,590	\$9,670
24 x 192x 29" H	Perimeter	CYA2 2419229RE S	2	6	\$10,060	\$11,140
24 x 192x 36" H	Centered	CYA1 2419236RE S	2	6	\$8,770	\$9,850
24 x 192x 36" H	Perimeter	CYA2 2419236RE S	2	6	\$10,240	\$11,320
24 x 192x 42" H	Centered	CYA1 2419242RE S	2	6	\$8,860	\$9,940
24 x 192x 42" H	Perimeter	CYA2 2419242RE S	2	6	\$10,330	\$11,410
24 x 240x 29" H	Centered	CYA1 2424029RE S	2	8	\$11,445	\$12,640
24 x 240x 29" H	Perimeter	CYA2 2424029RE S	2	8	\$13,590	\$14,785
24 x 240x 36" H	Centered	CYA1 2424036RE S	2	8	\$11,685	\$12,880
24 x 240x 36" H	Perimeter	CYA2 2424036RE S	2	8	\$13,830	\$15,025
24 x 240x 42" H	Centered	CYA1 2424042RE S	2	8	\$11,805	\$13,000
24 x 240x 42" H	Perimeter	CYA2 2424042RE S	2	8	\$13,950	\$15,145

POWER & A/V OPTIONS SEE PAGES 8-20

TABLE OPTIONS:

Laser cut holes in base - 1.5" x 2.5"

Locking Casters

Industrial Locking Casters

Paper Roll mounted to underside of table top

WB	\$50 list for two bases
CS	\$20 list per caster
CS	\$70 list per caster
ROLL	\$620 list per holder



**FINISHES NEEDED:** <http://hi5furniture.com/finishes/>

HPL Top: Hi5 Graded-in laminates or Non-Premium Wilsonart or Formica

Edge Color: Any Hi5 standard

Base Finish: Any Hi5 standard

NOTE: Raw Tube Steel with Clear Coat [RWT]

Coby Apron legs are tube steel, apron & foot rails are manufactured from sheet metal so Coby Apron bases will be two-toned if ordered in clear coat over raw steel



Table Size	Foot Rail Type	Model Code:	# of Pieces	# of Legs	List Price	List Price
30 x 36x 18" H	None	CYA0 303618RE S	1	4	\$2,750	\$2,890
30 x 36x 18" H	Centered	CYA1 303618RE S	1	4	\$3,575	\$3,715
30 x 36x 18" H	Perimeter	CYA2 303618RE S	1	4	\$3,900	\$4,040
30 x 36x 29" H	None	CYA0 303629RE S	1	4	\$2,790	\$2,930
30 x 36x 29" H	Centered	CYA1 303629RE S	1	4	\$3,615	\$3,755
30 x 36x 29" H	Perimeter	CYA2 303629RE S	1	4	\$3,940	\$4,080
30 x 36x 36" H	None	CYA0 303636RE S	1	4	\$2,910	\$3,050
30 x 36x 36" H	Centered	CYA1 303636RE S	1	4	\$3,735	\$3,875
30 x 36x 36" H	Perimeter	CYA2 303636RE S	1	4	\$4,060	\$4,200
30 x 36x 42" H	None	CYA0 303642RE S	1	4	\$2,970	\$3,110
30 x 36x 42" H	Centered	CYA1 303642RE S	1	4	\$3,795	\$3,935
30 x 36x 42" H	Perimeter	CYA2 303642RE S	1	4	\$4,120	\$4,260
30 x 42x 18" H	None	CYA0 304218RE S	1	4	\$2,870	\$3,030
30 x 42x 18" H	Centered	CYA1 304218RE S	1	4	\$3,710	\$3,870
30 x 42x 18" H	Perimeter	CYA2 304218RE S	1	4	\$4,050	\$4,210
30 x 42x 29" H	None	CYA0 304229RE S	1	4	\$2,910	\$3,070
30 x 42x 29" H	Centered	CYA1 304229RE S	1	4	\$3,750	\$3,910
30 x 42x 29" H	Perimeter	CYA2 304229RE S	1	4	\$4,090	\$4,250
30 x 42x 36" H	None	CYA0 304236RE S	1	4	\$3,030	\$3,190
30 x 42x 36" H	Centered	CYA1 304236RE S	1	4	\$3,870	\$4,030
30 x 42x 36" H	Perimeter	CYA2 304236RE S	1	4	\$4,210	\$4,370
30 x 42x 42" H	None	CYA0 304242RE S	1	4	\$3,090	\$3,250
30 x 42x 42" H	Centered	CYA1 304242RE S	1	4	\$3,930	\$4,090
30 x 42x 42" H	Perimeter	CYA2 304242RE S	1	4	\$4,270	\$4,430

POWER & A/V OPTIONS SEE PAGES 8-20

TABLE OPTIONS:

Laser cut holes in base - 1.5" x 2.5"

Locking Casters

Industrial Locking Casters

Paper Roll mounted to underside of table top

WB

CS

CS

ROLL

\$50 list for two bases

\$20 list per caster

\$70 list per caster

\$620 list per holder



**FINISHES NEEDED:** <http://hi5furniture.com/finishes/>

HPL Top: Hi5 Graded-in laminates or Non-Premium Wilsonart or Formica

Edge Color: Any Hi5 standard

Base Finish: Any Hi5 standard

NOTE: Raw Tube Steel with Clear Coat [RWT]

Coby Apron legs are tube steel, apron & foot rails are manufactured from sheet metal so Coby Apron bases will be two-toned if ordered in clear coat over raw steel



Table Size	Foot Rail Type	Model Code:	# of Pieces	# of Legs	List Price	List Price
30 x 48x 18" H	None	CYA0 304818RE S	1	4	\$2,920	\$3,085
30 x 48x 18" H	Centered	CYA1 304818RE S	1	4	\$3,795	\$3,960
30 x 48x 18" H	Perimeter	CYA2 304818RE S	1	4	\$4,170	\$4,335
30 x 48x 29" H	None	CYA0 304829RE S	1	4	\$2,960	\$3,125
30 x 48x 29" H	Centered	CYA1 304829RE S	1	4	\$3,835	\$4,000
30 x 48x 29" H	Perimeter	CYA2 304829RE S	1	4	\$4,210	\$4,375
30 x 48x 36" H	None	CYA0 304836RE S	1	4	\$3,080	\$3,245
30 x 48x 36" H	Centered	CYA1 304836RE S	1	4	\$3,955	\$4,120
30 x 48x 36" H	Perimeter	CYA2 304836RE S	1	4	\$4,330	\$4,495
30 x 48x 42" H	None	CYA0 304842RE S	1	4	\$3,140	\$3,305
30 x 48x 42" H	Centered	CYA1 304842RE S	1	4	\$4,015	\$4,180
30 x 48x 42" H	Perimeter	CYA2 304842RE S	1	4	\$4,390	\$4,555
30 x 60x 18" H	None	CYA0 306018RE S	1	4	\$3,010	\$3,190
30 x 60x 18" H	Centered	CYA1 306018RE S	1	4	\$3,980	\$4,160
30 x 60x 18" H	Perimeter	CYA2 306018RE S	1	4	\$4,450	\$4,630
30 x 60x 29" H	None	CYA0 306029RE S	1	4	\$3,050	\$3,230
30 x 60x 29" H	Centered	CYA1 306029RE S	1	4	\$4,020	\$4,200
30 x 60x 29" H	Perimeter	CYA2 306029RE S	1	4	\$4,490	\$4,670
30 x 60x 36" H	None	CYA0 306036RE S	1	4	\$3,170	\$3,350
30 x 60x 36" H	Centered	CYA1 306036RE S	1	4	\$4,140	\$4,320
30 x 60x 36" H	Perimeter	CYA2 306036RE S	1	4	\$4,610	\$4,790
30 x 60x 42" H	None	CYA0 306042RE S	1	4	\$3,230	\$3,410
30 x 60x 42" H	Centered	CYA1 306042RE S	1	4	\$4,200	\$4,380
30 x 60x 42" H	Perimeter	CYA2 306042RE S	1	4	\$4,670	\$4,850

POWER & A/V OPTIONS SEE PAGES 8-20

TABLE OPTIONS:

Laser cut holes in base - 1.5" x 2.5"

Locking Casters

Industrial Locking Casters

Paper Roll mounted to underside of table top

WB

CS

CS

ROLL

\$50 list for two bases

\$20 list per caster

\$70 list per caster

\$620 list per holder



**FINISHES NEEDED:** <http://hi5furniture.com/finishes/>

HPL Top: Hi5 Graded-in laminates or Non-Premium Wilsonart or Formica

Edge Color: Any Hi5 standard

Base Finish: Any Hi5 standard

NOTE: Raw Tube Steel with Clear Coat [RWT]

Coby Apron legs are tube steel, apron & foot rails are manufactured from sheet metal so Coby Apron bases will be two-toned if ordered in clear coat over raw steel



Table Size	Foot Rail Type	Model Code:	# of Pieces	# of Legs	List Price	List Price
30 x 72x 18" H	None	CYA0 307218RE S	1	4	\$3,220	\$3,455
30 x 72x 18" H	Centered	CYA1 307218RE S	1	4	\$4,435	\$4,670
30 x 72x 18" H	Perimeter	CYA2 307218RE S	1	4	\$5,150	\$5,385
30 x 72x 29" H	None	CYA0 307229RE S	1	4	\$3,260	\$3,495
30 x 72x 29" H	Centered	CYA1 307229RE S	1	4	\$4,475	\$4,710
30 x 72x 29" H	Perimeter	CYA2 307229RE S	1	4	\$5,190	\$5,425
30 x 72x 36" H	None	CYA0 307236RE S	1	4	\$3,380	\$3,615
30 x 72x 36" H	Centered	CYA1 307236RE S	1	4	\$4,595	\$4,830
30 x 72x 36" H	Perimeter	CYA2 307236RE S	1	4	\$5,310	\$5,545
30 x 72x 42" H	None	CYA0 303722RE S	1	4	\$3,440	\$3,675
30 x 72x 42" H	Centered	CYA1 303722RE S	1	4	\$4,655	\$4,890
30 x 72x 42" H	Perimeter	CYA2 303722RE S	1	4	\$5,370	\$5,605
30 x 84x 29" H	Centered	CYA1 308429RE S	1	4	\$4,615	\$4,885
30 x 84x 29" H	Perimeter	CYA2 308429RE S	1	4	\$5,340	\$5,610
30 x 84x 36" H	Centered	CYA1 308436RE S	1	4	\$4,735	\$5,005
30 x 84x 36" H	Perimeter	CYA2 308436RE S	1	4	\$5,460	\$5,730
30 x 84x 42" H	Centered	CYA1 308442RE S	1	4	\$4,795	\$5,065
30 x 84x 42" H	Perimeter	CYA2 308442RE S	1	4	\$5,520	\$5,790
30 x 96x 29" H	Centered	CYA1 309629RE S	1	4	\$4,645	\$4,920
30 x 96x 29" H	Perimeter	CYA2 309629RE S	1	4	\$5,380	\$5,655
30 x 96x 36" H	Centered	CYA1 309636RE S	1	4	\$4,695	\$4,970
30 x 96x 36" H	Perimeter	CYA2 309636RE S	1	4	\$5,500	\$5,775
30 x 96x 42" H	Centered	CYA1 309642RE S	1	4	\$4,825	\$5,100
30 x 96x 42" H	Perimeter	CYA2 309642RE S	1	4	\$5,560	\$5,835

POWER & A/V OPTIONS SEE PAGES 8-20

TABLE OPTIONS:

Laser cut holes in base - 1.5" x 2.5"

Locking Casters

Industrial Locking Casters

Paper Roll mounted to underside of table top

WB

CS

CS

ROLL

\$50 list for two bases

\$20 list per caster

\$70 list per caster

\$620 list per holder



**FINISHES NEEDED:** <http://hi5furniture.com/finishes/>

HPL Top: Hi5 Graded-in laminates or Non-Premium Wilsonart or Formica

Edge Color: Any Hi5 standard

Base Finish: Any Hi5 standard

NOTE: Raw Tube Steel with Clear Coat [RWT]

Coby Apron legs are tube steel, apron & foot rails are manufactured from sheet metal so Coby Apron bases will be two-toned if ordered in clear coat over raw steel



Table Size	Foot Rail Type	Model Code:	# of Pieces	# of Legs	List Price	List Price
30 x 120x 29" H	Centered	CYA1 3012029RE S	1	6	\$6,935	\$7,465
30 x 120x 29" H	Perimeter	CYA2 3012029RE S	1	6	\$7,875	\$8,405
30 x 120x 36" H	Centered	CYA1 3012036RE S	1	6	\$7,115	\$7,645
30 x 120x 36" H	Perimeter	CYA2 3012036RE S	1	6	\$8,055	\$8,585
30 x 120x 42" H	Centered	CYA1 3012042RE S	1	6	\$7,205	\$7,735
30 x 120x 42" H	Perimeter	CYA2 3012042RE S	1	6	\$8,145	\$8,675
30 x 144x 29" H	Centered	CYA1 3014429RE S	2	6	\$8,575	\$9,650
30 x 144x 29" H	Perimeter	CYA2 3014429RE S	2	6	\$10,005	\$11,080
30 x 144x 36" H	Centered	CYA1 3014436RE S	2	6	\$8,755	\$9,830
30 x 144x 36" H	Perimeter	CYA2 3014436RE S	2	6	\$10,185	\$11,260
30 x 144x 42" H	Centered	CYA1 3014442RE S	2	6	\$8,845	\$9,920
30 x 144x 42" H	Perimeter	CYA2 3014442RE S	2	6	\$10,275	\$11,350
30 x 168x 29" H	Centered	CYA1 3016829RE S	2	6	\$8,855	\$10,050
30 x 168x 29" H	Perimeter	CYA2 3016829RE S	2	6	\$10,305	\$11,500
30 x 168x 36" H	Centered	CYA1 3016836RE S	2	6	\$9,035	\$10,230
30 x 168x 36" H	Perimeter	CYA2 3016836RE S	2	6	\$10,485	\$11,680
30 x 168x 42" H	Centered	CYA1 3016842RE S	2	6	\$9,125	\$10,320
30 x 168x 42" H	Perimeter	CYA2 3016842RE S	2	6	\$10,575	\$11,770

POWER & A/V OPTIONS SEE PAGES 8-20

TABLE OPTIONS:

Laser cut holes in base - 1.5" x 2.5"

Locking Casters

Industrial Locking Casters

Paper Roll mounted to underside of table top

WB	\$50 list for two bases
CS	\$20 list per caster
CS	\$70 list per caster
ROLL	\$620 list per holder



**FINISHES NEEDED:** <http://hi5furniture.com/finishes/>

HPL Top: Hi5 Graded-in laminates or Non-Premium Wilsonart or Formica

Edge Color: Any Hi5 standard

Base Finish: Any Hi5 standard

NOTE: Raw Tube Steel with Clear Coat [RWT]

Coby Apron legs are tube steel, apron & foot rails are manufactured from sheet metal so Coby Apron bases will be two-toned if ordered in clear coat over raw steel



Table Size	Foot Rail Type	Model Code:	# of Pieces	# of Legs	List Price	List Price
30 x 192x 29" H	Centered	CYA1 3019229RE S	2	6	\$8,925	\$10,135
30 x 192x 29" H	Perimeter	CYA2 3019229RE S	2	6	\$10,395	\$11,605
30 x 192x 36" H	Centered	CYA1 3019236RE S	2	6	\$9,105	\$10,315
30 x 192x 36" H	Perimeter	CYA2 3019236RE S	2	6	\$10,575	\$11,785
30 x 192x 42" H	Centered	CYA1 3019242RE S	2	6	\$9,195	\$10,405
30 x 192x 42" H	Perimeter	CYA2 3019242RE S	2	6	\$10,665	\$11,875
30 x 240x 29" H	Centered	CYA1 3024029RE S	2	8	\$11,845	\$13,190
30 x 240x 29" H	Perimeter	CYA2 3024029RE S	2	8	\$13,990	\$15,335
30 x 240x 36" H	Centered	CYA1 3024036RE S	2	8	\$12,085	\$13,430
30 x 240x 36" H	Perimeter	CYA2 3024036RE S	2	8	\$14,230	\$15,575
30 x 240x 42" H	Centered	CYA1 3024042RE S	2	8	\$12,205	\$13,550
30 x 240x 42" H	Perimeter	CYA2 3024042RE S	2	8	\$14,350	\$15,695

POWER & A/V OPTIONS SEE PAGES 8-20

TABLE OPTIONS:

Laser cut holes in base - 1.5" x 2.5"

Locking Casters

Industrial Locking Casters

Paper Roll mounted to underside of table top

WB	\$50 list for two bases
CS	\$20 list per caster
CS	\$70 list per caster
ROLL	\$620 list per holder



**FINISHES NEEDED:** <http://hi5furniture.com/finishes/>

HPL Top: Hi5 Graded-in laminates or Non-Premium Wilsonart or Formica

Edge Color: Any Hi5 standard

Base Finish: Any Hi5 standard

NOTE: Raw Tube Steel with Clear Coat [RWT]

Coby Apron legs are tube steel, apron & foot rails are manufactured from sheet metal so Coby Apron bases will be two-toned if ordered in clear coat over raw steel



Table Size	Foot Rail Type	Model Code:	# of Pieces	# of Legs	List Price	List Price
36 x 42x 18" H	None	CYA0 364218RE S	1	4	\$2,950	\$3,125
36 x 42x 18" H	Centered	CYA1 364218RE S	1	4	\$3,940	\$4,115
36 x 42x 18" H	Perimeter	CYA2 364218RE S	1	4	\$4,280	\$4,455
36 x 42x 29" H	None	CYA0 364229RE S	1	4	\$2,990	\$3,165
36 x 42x 29" H	Centered	CYA1 364229RE S	1	4	\$3,980	\$4,155
36 x 42x 29" H	Perimeter	CYA2 364229RE S	1	4	\$4,320	\$4,495
36 x 42x 36" H	None	CYA0 364236RE S	1	4	\$3,110	\$3,285
36 x 42x 36" H	Centered	CYA1 364236RE S	1	4	\$4,100	\$4,275
36 x 42x 36" H	Perimeter	CYA2 364236RE S	1	4	\$4,440	\$4,615
36 x 42x 42" H	None	CYA0 364242RE S	1	4	\$3,170	\$3,345
36 x 42x 42" H	Centered	CYA1 364242RE S	1	4	\$4,160	\$4,335
36 x 42x 42" H	Perimeter	CYA2 364242RE S	1	4	\$4,500	\$4,675
36 x 48x 18" H	None	CYA0 364818RE S	1	4	\$3,000	\$3,180
36 x 48x 18" H	Centered	CYA1 364818RE S	1	4	\$4,025	\$4,205
36 x 48x 18" H	Perimeter	CYA2 364818RE S	1	4	\$4,400	\$4,580
36 x 48x 29" H	None	CYA0 364829RE S	1	4	\$3,040	\$3,220
36 x 48x 29" H	Centered	CYA1 364829RE S	1	4	\$4,065	\$4,245
36 x 48x 29" H	Perimeter	CYA2 364829RE S	1	4	\$4,440	\$4,620
36 x 48x 36" H	None	CYA0 364836RE S	1	4	\$3,160	\$3,340
36 x 48x 36" H	Centered	CYA1 364836RE S	1	4	\$4,185	\$4,365
36 x 48x 36" H	Perimeter	CYA2 364836RE S	1	4	\$4,560	\$4,740
36 x 48x 42" H	None	CYA0 364842RE S	1	4	\$3,220	\$3,400
36 x 48x 42" H	Centered	CYA1 364842RE S	1	4	\$4,245	\$4,425
36 x 48x 42" H	Perimeter	CYA2 364842RE S	1	4	\$4,620	\$4,800

POWER & A/V OPTIONS SEE PAGES 8-20

TABLE OPTIONS:

Laser cut holes in base - 1.5" x 2.5"

Locking Casters

Industrial Locking Casters

Paper Roll mounted to underside of table top

WB

CS

CS

ROLL

\$50 list for two bases

\$20 list per caster

\$70 list per caster

\$620 list per holder





**FINISHES NEEDED:** <http://hi5furniture.com/finishes/>

HPL Top: Hi5 Graded-in laminates or Non-Premium Wilsonart or Formica

Edge Color: Any Hi5 standard

Base Finish: Any Hi5 standard

NOTE: Raw Tube Steel with Clear Coat [RWT]

Coby Apron legs are tube steel, apron & foot rails are manufactured from sheet metal so Coby Apron bases will be two-toned if ordered in clear coat over raw steel



Table Size	Foot Rail Type	Model Code:	# of Pieces	# of Legs	List Price	List Price
36 x 60x 18" H	None	CYA0 366018RE S	1	4	\$3,110	\$3,315
36 x 60x 18" H	Centered	CYA1 366018RE S	1	4	\$4,230	\$4,435
36 x 60x 18" H	Perimeter	CYA2 366018RE S	1	4	\$4,700	\$4,905
36 x 60x 29" H	None	CYA0 366029RE S	1	4	\$3,150	\$3,355
36 x 60x 29" H	Centered	CYA1 366029RE S	1	4	\$4,270	\$4,475
36 x 60x 29" H	Perimeter	CYA2 366029RE S	1	4	\$4,740	\$4,945
36 x 60x 36" H	None	CYA0 366036RE S	1	4	\$3,270	\$3,475
36 x 60x 36" H	Centered	CYA1 366036RE S	1	4	\$4,390	\$4,595
36 x 60x 36" H	Perimeter	CYA2 366036RE S	1	4	\$4,860	\$5,065
36 x 60x 42" H	None	CYA0 366042RE S	1	4	\$3,330	\$3,535
36 x 60x 42" H	Centered	CYA1 366042RE S	1	4	\$4,450	\$4,655
36 x 60x 42" H	Perimeter	CYA2 366042RE S	1	4	\$4,920	\$5,125
36 x 72x 18" H	None	CYA0 367218RE S	1	4	\$3,320	\$3,575
36 x 72x 18" H	Centered	CYA1 367218RE S	1	4	\$4,685	\$4,940
36 x 72x 18" H	Perimeter	CYA2 367218RE S	1	4	\$5,400	\$5,655
36 x 72x 29" H	None	CYA0 367229RE S	1	4	\$3,360	\$3,615
36 x 72x 29" H	Centered	CYA1 367229RE S	1	4	\$4,725	\$4,980
36 x 72x 29" H	Perimeter	CYA2 367229RE S	1	4	\$5,440	\$5,695
36 x 72x 36" H	None	CYA0 367236RE S	1	4	\$3,480	\$3,735
36 x 72x 36" H	Centered	CYA1 367236RE S	1	4	\$4,845	\$5,100
36 x 72x 36" H	Perimeter	CYA2 367236RE S	1	4	\$5,560	\$5,815
36 x 72x 42" H	None	CYA0 367242RE S	1	4	\$3,540	\$3,795
36 x 72x 42" H	Centered	CYA1 367242RE S	1	4	\$4,905	\$5,160
36 x 72x 42" H	Perimeter	CYA2 367242RE S	1	4	\$5,620	\$5,875

POWER & A/V OPTIONS SEE PAGES 8-20

TABLE OPTIONS:

Laser cut holes in base - 1.5" x 2.5"

Locking Casters

Industrial Locking Casters

Paper Roll mounted to underside of table top

WB

CS

CS

ROLL

\$50 list for two bases

\$20 list per caster

\$70 list per caster

\$620 list per holder



**FINISHES NEEDED:** <http://hi5furniture.com/finishes/>

HPL Top: Hi5 Graded-in laminates or Non-Premium Wilsonart or Formica

Edge Color: Any Hi5 standard

Base Finish: Any Hi5 standard

NOTE: Raw Tube Steel with Clear Coat [RWT]

Coby Apron legs are tube steel, apron & foot rails are manufactured from sheet metal so Coby Apron bases will be two-toned if ordered in clear coat over raw steel



Table Size	Foot Rail Type	Model Code:	# of Pieces	# of Legs	List Price	List Price
36 x 84x 29" H	Centered	CYA1 368429RE S	1	4	\$4,895	\$5,195
36 x 84x 29" H	Perimeter	CYA2 368429RE S	1	4	\$5,620	\$5,920
36 x 84x 36" H	Centered	CYA1 368436RE S	1	4	\$5,015	\$5,315
36 x 84x 36" H	Perimeter	CYA2 368436RE S	1	4	\$5,740	\$6,040
36 x 84x 42" H	Centered	CYA1 368442RE S	1	4	\$5,075	\$5,375
36 x 84x 42" H	Perimeter	CYA2 368442RE S	1	4	\$5,800	\$6,100
36 x 96x 29" H	Centered	CYA1 369629RE S	1	4	\$4,925	\$5,230
36 x 96x 29" H	Perimeter	CYA2 369629RE S	1	4	\$5,660	\$5,965
36 x 96x 36" H	Centered	CYA1 369636RE S	1	4	\$4,975	\$5,280
36 x 96x 36" H	Perimeter	CYA2 369636RE S	1	4	\$5,780	\$6,085
36 x 96x 42" H	Centered	CYA1 369642RE S	1	4	\$5,105	\$5,410
36 x 96x 42" H	Perimeter	CYA2 369642RE S	1	4	\$5,840	\$6,145
36 x 120x 29" H	Centered	CYA1 3612029RE S	1	6	\$7,335	\$7,930
36 x 120x 29" H	Perimeter	CYA2 3612029RE S	1	6	\$8,275	\$8,870
36 x 120x 36" H	Centered	CYA1 3612036RE S	1	6	\$7,515	\$8,110
36 x 120x 36" H	Perimeter	CYA2 3612036RE S	1	6	\$8,455	\$9,050
36 x 120x 42" H	Centered	CYA1 3612042RE S	1	6	\$7,605	\$8,200
36 x 120x 42" H	Perimeter	CYA2 3612042RE S	1	6	\$8,545	\$9,140

POWER & A/V OPTIONS SEE PAGES 8-20

TABLE OPTIONS:

Laser cut holes in base - 1.5" x 2.5"

Locking Casters

Industrial Locking Casters

Paper Roll mounted to underside of table top

WB	\$50 list for two bases
CS	\$20 list per caster
CS	\$70 list per caster
ROLL	\$620 list per holder



**FINISHES NEEDED:** <http://hi5furniture.com/finishes/>

HPL Top: Hi5 Graded-in laminates or Non-Premium Wilsonart or Formica

Edge Color: Any Hi5 standard

Base Finish: Any Hi5 standard

NOTE: Raw Tube Steel with Clear Coat [RWT]

Coby Apron legs are tube steel, apron & foot rails are manufactured from sheet metal so Coby Apron bases will be two-toned if ordered in clear coat over raw steel



Table Size	Foot Rail Type	Model Code:	# of Pieces	# of Legs	List Price	List Price
36 x 144x 29" H	Centered	CYA1 3614429RE S	2	6	\$9,065	\$10,250
36 x 144x 29" H	Perimeter	CYA2 3614429RE S	2	6	\$10,495	\$11,680
36 x 144x 36" H	Centered	CYA1 3614436RE S	2	6	\$9,245	\$10,430
36 x 144x 36" H	Perimeter	CYA2 3614436RE S	2	6	\$10,675	\$11,860
36 x 144x 42" H	Centered	CYA1 3614442RE S	2	6	\$9,335	\$10,520
36 x 144x 42" H	Perimeter	CYA2 3614442RE S	2	6	\$10,765	\$11,950
36 x 168x 29" H	Centered	CYA1 3616829RE S	2	6	\$9,385	\$10,710
36 x 168x 29" H	Perimeter	CYA2 3616829RE S	2	6	\$10,835	\$12,160
36 x 168x 36" H	Centered	CYA1 3616836RE S	2	6	\$9,565	\$10,890
36 x 168x 36" H	Perimeter	CYA2 3616836RE S	2	6	\$11,015	\$12,340
36 x 168x 42" H	Centered	CYA1 3616842RE S	2	6	\$9,655	\$10,980
36 x 168x 42" H	Perimeter	CYA2 3616842RE S	2	6	\$11,105	\$12,430
36 x 192x 29" H	Centered	CYA1 3619229RE S	2	6	\$9,455	\$10,795
36 x 192x 29" H	Perimeter	CYA2 3619229RE S	2	6	\$10,925	\$12,265
36 x 192x 36" H	Centered	CYA1 3619236RE S	2	6	\$9,635	\$10,975
36 x 192x 36" H	Perimeter	CYA2 3619236RE S	2	6	\$11,105	\$12,445
36 x 192x 42" H	Centered	CYA1 3619242RE S	2	6	\$9,725	\$11,065
36 x 192x 42" H	Perimeter	CYA2 3619242RE S	2	6	\$11,195	\$12,535

POWER & A/V OPTIONS SEE PAGES 8-20

TABLE OPTIONS:

Laser cut holes in base - 1.5" x 2.5"

Locking Casters

Industrial Locking Casters

Paper Roll mounted to underside of table top

WB	\$50 list for two bases
CS	\$20 list per caster
CS	\$70 list per caster
ROLL	\$620 list per holder



**FINISHES NEEDED:** <http://hi5furniture.com/finishes/>

HPL Top: Hi5 Graded-in laminates or Non-Premium Wilsonart or Formica

Edge Color: Any Hi5 standard

Base Finish: Any Hi5 standard

NOTE: Raw Tube Steel with Clear Coat [RWT]

Coby Apron legs are tube steel, apron & foot rails are manufactured from sheet metal so Coby Apron bases will be two-toned if ordered in clear coat over raw steel



Table Size	Foot Rail Type	Model Code:	# of Pieces	# of Legs	List Price	List Price
36 x 240x 29" H	Centered	CYA1 3624029RE S	2	8	\$12,505	\$14,000
36 x 240x 29" H	Perimeter	CYA2 3624029RE S	2	8	\$14,650	\$16,145
36 x 240x 36" H	Centered	CYA1 3624036RE S	2	8	\$12,745	\$14,240
36 x 240x 36" H	Perimeter	CYA2 3624036RE S	2	8	\$14,890	\$16,385
36 x 240x 42" H	Centered	CYA1 3624042RE S	2	8	\$12,865	\$14,360
36 x 240x 42" H	Perimeter	CYA2 3624042RE S	2	8	\$15,010	\$16,505

POWER & A/V OPTIONS SEE PAGES 8-20

TABLE OPTIONS:

Laser cut holes in base - 1.5" x 2.5"

Locking Casters

Industrial Locking Casters

Paper Roll mounted to underside of table top

WB	\$50 list for two bases
CS	\$20 list per caster
CS	\$70 list per caster
ROLL	\$620 list per holder



**FINISHES NEEDED:** <http://hi5furniture.com/finishes/>

HPL Top: Hi5 Graded-in laminates or Non-Premium Wilsonart or Formica

Edge Color: Any Hi5 standard

Base Finish: Any Hi5 standard

NOTE: Raw Tube Steel with Clear Coat [RWT]

Coby Apron legs are tube steel, apron & foot rails are manufactured from sheet metal so Coby Apron bases will be two-toned if ordered in clear coat over raw steel



Table Size	Foot Rail Type	Model Code:	# of Pieces	# of Legs	List Price	List Price
42 x 48x 29" H	None	CYA0 424829RE S	1	4	\$3,190	\$3,400
42 x 48x 29" H	Centered	CYA1 424829RE S	1	4	\$4,245	\$4,455
42 x 48x 29" H	Perimeter	CYA2 424829RE S	1	4	\$4,620	\$4,830
42 x 48x 36" H	None	CYA0 424836RE S	1	4	\$3,310	\$3,520
42 x 48x 36" H	Centered	CYA1 424836RE S	1	4	\$4,365	\$4,575
42 x 48x 36" H	Perimeter	CYA2 424836RE S	1	4	\$4,740	\$4,950
42 x 48x 42" H	None	CYA0 424842RE S	1	4	\$3,370	\$3,580
42 x 48x 42" H	Centered	CYA1 424842RE S	1	4	\$4,425	\$4,635
42 x 48x 42" H	Perimeter	CYA2 424842RE S	1	4	\$4,800	\$5,010
42 x 60x 29" H	None	CYA0 426029RE S	1	4	\$3,420	\$3,690
42 x 60x 29" H	Centered	CYA1 426029RE S	1	4	\$4,570	\$4,840
42 x 60x 29" H	Perimeter	CYA2 426029RE S	1	4	\$5,040	\$5,310
42 x 60x 36" H	None	CYA0 426036RE S	1	4	\$3,540	\$3,810
42 x 60x 36" H	Centered	CYA1 426036RE S	1	4	\$4,690	\$4,960
42 x 60x 36" H	Perimeter	CYA2 426036RE S	1	4	\$5,160	\$5,430
42 x 60x 42" H	None	CYA0 426042RE S	1	4	\$3,600	\$3,870
42 x 60x 42" H	Centered	CYA1 426042RE S	1	4	\$4,750	\$5,020
42 x 60x 42" H	Perimeter	CYA2 426042RE S	1	4	\$5,220	\$5,490

POWER & A/V OPTIONS SEE PAGES 8-20

TABLE OPTIONS:

Laser cut holes in base - 1.5" x 2.5"

Locking Casters

Industrial Locking Casters

Paper Roll mounted to underside of table top

WB	\$50 list for two bases
CS	\$20 list per caster
CS	\$70 list per caster
ROLL	\$620 list per holder



**FINISHES NEEDED:** <http://hi5furniture.com/finishes/>

HPL Top: Hi5 Graded-in laminates or Non-Premium Wilsonart or Formica

Edge Color: Any Hi5 standard

Base Finish: Any Hi5 standard

NOTE: Raw Tube Steel with Clear Coat [RWT]

Coby Apron legs are tube steel, apron & foot rails are manufactured from sheet metal so Coby Apron bases will be two-toned if ordered in clear coat over raw steel



Table Size	Foot Rail Type	Model Code:	# of Pieces	# of Legs	List Price	List Price
42 x 72x 29" H	None	CYA0 427229RE S	1	4	\$3,550	\$3,850
42 x 72x 29" H	Centered	CYA1 427229RE S	1	4	\$4,945	\$5,245
42 x 72x 29" H	Perimeter	CYA2 427229RE S	1	4	\$5,660	\$5,960
42 x 72x 36" H	None	CYA0 427236RE S	1	4	\$3,670	\$3,970
42 x 72x 36" H	Centered	CYA1 427236RE S	1	4	\$5,065	\$5,365
42 x 72x 36" H	Perimeter	CYA2 427236RE S	1	4	\$5,780	\$6,080
42 x 72x 42" H	None	CYA0 423722RE S	1	4	\$3,730	\$4,030
42 x 72x 42" H	Centered	CYA1 423722RE S	1	4	\$5,125	\$5,425
42 x 72x 42" H	Perimeter	CYA2 423722RE S	1	4	\$5,840	\$6,140
42 x 84x 29" H	Centered	CYA1 428429RE S	1	4	\$5,165	\$5,525
42 x 84x 29" H	Perimeter	CYA2 428429RE S	1	4	\$5,890	\$6,250
42 x 84x 36" H	Centered	CYA1 428436RE S	1	4	\$5,285	\$5,645
42 x 84x 36" H	Perimeter	CYA2 428436RE S	1	4	\$6,010	\$6,370
42 x 84x 42" H	Centered	CYA1 428442RE S	1	4	\$5,345	\$5,705
42 x 84x 42" H	Perimeter	CYA2 428442RE S	1	4	\$6,070	\$6,430
42 x 96x 29" H	Centered	CYA1 429629RE S	1	4	\$5,205	\$5,570
42 x 96x 29" H	Perimeter	CYA2 429629RE S	1	4	\$5,940	\$6,305
42 x 96x 36" H	Centered	CYA1 429636RE S	1	4	\$5,255	\$5,620
42 x 96x 36" H	Perimeter	CYA2 429636RE S	1	4	\$6,060	\$6,425
42 x 96x 42" H	Centered	CYA1 429642RE S	1	4	\$5,385	\$5,750
42 x 96x 42" H	Perimeter	CYA2 429642RE S	1	4	\$6,120	\$6,485

POWER & A/V OPTIONS SEE PAGES 8-20

TABLE OPTIONS:

Laser cut holes in base - 1.5" x 2.5"

Locking Casters

Industrial Locking Casters

Paper Roll mounted to underside of table top

WB

CS

CS

ROLL

\$50 list for two bases

\$20 list per caster

\$70 list per caster

\$620 list per holder



**FINISHES NEEDED:** <http://hi5furniture.com/finishes/>

HPL Top: Hi5 Graded-in laminates or Non-Premium Wilsonart or Formica

Edge Color: Any Hi5 standard

Base Finish: Any Hi5 standard

NOTE: Raw Tube Steel with Clear Coat [RWT]

Coby Apron legs are tube steel, apron & foot rails are manufactured from sheet metal so Coby Apron bases will be two-toned if ordered in clear coat over raw steel



Table Size	Foot Rail Type	Model Code:	# of Pieces	# of Legs	List Price	List Price
42 x 120x 29" H	Centered	CYA1 4212029RE S	1	6	\$7,695	\$8,410
42 x 120x 29" H	Perimeter	CYA2 4212029RE S	1	6	\$8,635	\$9,350
42 x 120x 36" H	Centered	CYA1 4212036RE S	1	6	\$7,875	\$8,590
42 x 120x 36" H	Perimeter	CYA2 4212036RE S	1	6	\$8,815	\$9,530
42 x 120x 42" H	Centered	CYA1 4212042RE S	1	6	\$7,965	\$8,680
42 x 120x 42" H	Perimeter	CYA2 4212042RE S	1	6	\$8,905	\$9,620
42 x 144x 29" H	Centered	CYA1 4214429RE S	2	6	\$9,455	\$10,775
42 x 144x 29" H	Perimeter	CYA2 4214429RE S	2	6	\$10,885	\$12,205
42 x 144x 36" H	Centered	CYA1 4214436RE S	2	6	\$9,635	\$10,955
42 x 144x 36" H	Perimeter	CYA2 4214436RE S	2	6	\$11,065	\$12,385
42 x 144x 42" H	Centered	CYA1 4214442RE S	2	6	\$9,725	\$11,045
42 x 144x 42" H	Perimeter	CYA2 4214442RE S	2	6	\$11,155	\$12,475
42 x 168x 29" H	Centered	CYA1 4216829RE S	2	6	\$9,855	\$11,355
42 x 168x 29" H	Perimeter	CYA2 4216829RE S	2	6	\$11,305	\$12,805
42 x 168x 36" H	Centered	CYA1 4216836RE S	2	6	\$10,035	\$11,535
42 x 168x 36" H	Perimeter	CYA2 4216836RE S	2	6	\$11,485	\$12,985
42 x 168x 42" H	Centered	CYA1 4216842RE S	2	6	\$10,125	\$11,625
42 x 168x 42" H	Perimeter	CYA2 4216842RE S	2	6	\$11,575	\$13,075

POWER & A/V OPTIONS SEE PAGES 8-20

TABLE OPTIONS:

Laser cut holes in base - 1.5" x 2.5"

Locking Casters

Industrial Locking Casters

Paper Roll mounted to underside of table top

WB

CS

CS

ROLL

\$50 list for two bases

\$20 list per caster

\$70 list per caster

\$620 list per holder



**FINISHES NEEDED:** <http://hi5furniture.com/finishes/>

HPL Top: Hi5 Graded-in laminates or Non-Premium Wilsonart or Formica

Edge Color: Any Hi5 standard

Base Finish: Any Hi5 standard

NOTE: Raw Tube Steel with Clear Coat [RWT]

Coby Apron legs are tube steel, apron & foot rails are manufactured from sheet metal so Coby Apron bases will be two-toned if ordered in clear coat over raw steel



Table Size	Foot Rail Type	Model Code:	# of Pieces	# of Legs	List Price	List Price
42 x 192x 29" H	Centered	CYA1 4219229RE S	2	6	\$9,925	\$11,440
42 x 192x 29" H	Perimeter	CYA2 4219229RE S	2	6	\$11,395	\$12,910
42 x 192x 36" H	Centered	CYA1 4219236RE S	2	6	\$10,105	\$11,620
42 x 192x 36" H	Perimeter	CYA2 4219236RE S	2	6	\$11,575	\$13,090
42 x 192x 42" H	Centered	CYA1 4219242RE S	2	6	\$10,195	\$11,710
42 x 192x 42" H	Perimeter	CYA2 4219242RE S	2	6	\$11,665	\$13,180
42 x 240x 29" H	Centered	CYA1 4224029RE S	2	8	\$13,095	\$14,805
42 x 240x 29" H	Perimeter	CYA2 4224029RE S	2	8	\$15,240	\$16,950
42 x 240x 36" H	Centered	CYA1 4224036RE S	2	8	\$13,335	\$15,045
42 x 240x 36" H	Perimeter	CYA2 4224036RE S	2	8	\$15,480	\$17,190
42 x 240x 42" H	Centered	CYA1 4224042RE S	2	8	\$13,455	\$15,165
42 x 240x 42" H	Perimeter	CYA2 4224042RE S	2	8	\$15,600	\$17,310

POWER & A/V OPTIONS SEE PAGES 8-20

TABLE OPTIONS:

Laser cut holes in base - 1.5" x 2.5"

Locking Casters

Industrial Locking Casters

Paper Roll mounted to underside of table top

WB	\$50 list for two bases
CS	\$20 list per caster
CS	\$70 list per caster
ROLL	\$620 list per holder





**FINISHES NEEDED:** <http://hi5furniture.com/finishes/>

HPL Top: Hi5 Graded-in laminates or Non-Premium Wilsonart or Formica

Edge Color: Any Hi5 standard

Base Finish: Any Hi5 standard

NOTE: Raw Tube Steel with Clear Coat [RWT]

Coby Apron legs are tube steel, apron & foot rails are manufactured from sheet metal so Coby Apron bases will be two-toned if ordered in clear coat over raw steel



Table Size	Foot Rail Type	Model Code:	# of Pieces	# of Legs	List Price	List Price
48 x 60x 29" H	None	CYA0 486029RE S	1	4	\$3,530	\$3,820
48 x 60x 29" H	Centered	CYA1 486029RE S	1	4	\$4,750	\$5,040
48 x 60x 29" H	Perimeter	CYA2 486029RE S	1	4	\$5,220	\$5,510
48 x 60x 36" H	None	CYA0 486036RE S	1	4	\$3,650	\$3,940
48 x 60x 36" H	Centered	CYA1 486036RE S	1	4	\$4,870	\$5,160
48 x 60x 36" H	Perimeter	CYA2 486036RE S	1	4	\$5,340	\$5,630
48 x 60x 42" H	None	CYA0 486042RE S	1	4	\$3,710	\$4,000
48 x 60x 42" H	Centered	CYA1 486042RE S	1	4	\$4,930	\$5,220
48 x 60x 42" H	Perimeter	CYA2 486042RE S	1	4	\$5,400	\$5,690
48 x 72x 29" H	None	CYA0 487229RE S	1	4	\$3,590	\$3,890
48 x 72x 29" H	Centered	CYA1 487229RE S	1	4	\$5,055	\$5,355
48 x 72x 29" H	Perimeter	CYA2 487229RE S	1	4	\$5,770	\$6,070
48 x 72x 36" H	None	CYA0 487236RE S	1	4	\$3,710	\$4,010
48 x 72x 36" H	Centered	CYA1 487236RE S	1	4	\$5,175	\$5,475
48 x 72x 36" H	Perimeter	CYA2 487236RE S	1	4	\$5,890	\$6,190
48 x 72x 42" H	None	CYA0 487242RE S	1	4	\$3,770	\$4,070
48 x 72x 42" H	Centered	CYA1 487242RE S	1	4	\$5,235	\$5,535
48 x 72x 42" H	Perimeter	CYA2 487242RE S	1	4	\$5,950	\$6,250
48 x 84x 29" H	Centered	CYA1 488429RE S	1	4	\$5,275	\$5,635
48 x 84x 29" H	Perimeter	CYA2 488429RE S	1	4	\$6,000	\$6,360
48 x 84x 36" H	Centered	CYA1 488436RE S	1	4	\$5,395	\$5,755
48 x 84x 36" H	Perimeter	CYA2 488436RE S	1	4	\$6,120	\$6,480
48 x 84x 42" H	Centered	CYA1 488442RE S	1	4	\$5,455	\$5,815
48 x 84x 42" H	Perimeter	CYA2 488442RE S	1	4	\$6,180	\$6,540

POWER & A/V OPTIONS SEE PAGES 8-20

TABLE OPTIONS:

Laser cut holes in base - 1.5" x 2.5"

Locking Casters

Industrial Locking Casters

Paper Roll mounted to underside of table top

WB

CS

CS

ROLL

\$50 list for two bases

\$20 list per caster

\$70 list per caster

\$620 list per holder



**FINISHES NEEDED:** <http://hi5furniture.com/finishes/>

HPL Top: Hi5 Graded-in laminates or Non-Premium Wilsonart or Formica

Edge Color: Any Hi5 standard

Base Finish: Any Hi5 standard

NOTE: Raw Tube Steel with Clear Coat [RWT]

Coby Apron legs are tube steel, apron & foot rails are manufactured from sheet metal so Coby Apron bases will be two-toned if ordered in clear coat over raw steel



Table Size	Foot Rail Type	Model Code:	# of Pieces	# of Legs	List Price	List Price
48 x 96x 29" H	Centered	CYA1 489629RE S	1	4	\$5,315	\$5,680
48 x 96x 29" H	Perimeter	CYA2 489629RE S	1	4	\$6,050	\$6,415
48 x 96x 36" H	Centered	CYA1 489636RE S	1	4	\$4,365	\$4,730
48 x 96x 36" H	Perimeter	CYA2 489636RE S	1	4	\$6,170	\$6,535
48 x 96x 42" H	Centered	CYA1 489642RE S	1	4	\$5,495	\$5,860
48 x 96x 42" H	Perimeter	CYA2 489642RE S	1	4	\$6,230	\$6,595
48 x 120x 29" H	Centered	CYA1 4812029RE S	1	6	\$7,860	\$8,575
48 x 120x 29" H	Perimeter	CYA2 4812029RE S	1	6	\$8,800	\$9,515
48 x 120x 36" H	Centered	CYA1 4812036RE S	1	6	\$8,040	\$8,755
48 x 120x 36" H	Perimeter	CYA2 4812036RE S	1	6	\$8,980	\$9,695
48 x 120x 42" H	Centered	CYA1 4812042RE S	1	6	\$8,130	\$8,845
48 x 120x 42" H	Perimeter	CYA2 4812042RE S	1	6	\$9,070	\$9,785
48 x 144x 29" H	Centered	CYA1 4814429RE S	2	6	\$9,620	\$10,940
48 x 144x 29" H	Perimeter	CYA2 4814429RE S	2	6	\$11,050	\$12,370
48 x 144x 36" H	Centered	CYA1 4814436RE S	2	6	\$9,800	\$11,120
48 x 144x 36" H	Perimeter	CYA2 4814436RE S	2	6	\$11,230	\$12,550
48 x 144x 42" H	Centered	CYA1 4814442RE S	2	6	\$9,890	\$11,210
48 x 144x 42" H	Perimeter	CYA2 4814442RE S	2	6	\$11,320	\$12,640

POWER & A/V OPTIONS SEE PAGES 8-20

TABLE OPTIONS:

Laser cut holes in base - 1.5" x 2.5"

Locking Casters

Industrial Locking Casters

Paper Roll mounted to underside of table top

WB	\$50 list for two bases
CS	\$20 list per caster
CS	\$70 list per caster
ROLL	\$620 list per holder



**FINISHES NEEDED:** <http://hi5furniture.com/finishes/>

HPL Top: Hi5 Graded-in laminates or Non-Premium Wilsonart or Formica

Edge Color: Any Hi5 standard

Base Finish: Any Hi5 standard

NOTE: Raw Tube Steel with Clear Coat [RWT]

Coby Apron legs are tube steel, apron & foot rails are manufactured from sheet metal so Coby Apron bases will be two-toned if ordered in clear coat over raw steel



Table Size	Foot Rail Type	Model Code:	# of Pieces	# of Legs	List Price	List Price
48 x 168x 29" H	Centered	CYA1 4816829RE S	2	6	\$10,020	\$11,520
48 x 168x 29" H	Perimeter	CYA2 4816829RE S	2	6	\$11,470	\$12,970
48 x 168x 36" H	Centered	CYA1 4816836RE S	2	6	\$10,200	\$11,700
48 x 168x 36" H	Perimeter	CYA2 4816836RE S	2	6	\$11,650	\$13,150
48 x 168x 42" H	Centered	CYA1 4816842RE S	2	6	\$10,290	\$11,790
48 x 168x 42" H	Perimeter	CYA2 4816842RE S	2	6	\$11,740	\$13,240
48 x 192x 29" H	Centered	CYA1 4819229RE S	2	6	\$10,090	\$11,605
48 x 192x 29" H	Perimeter	CYA2 4819229RE S	2	6	\$11,560	\$13,075
48 x 192x 36" H	Centered	CYA1 4819236RE S	2	6	\$10,270	\$11,785
48 x 192x 36" H	Perimeter	CYA2 4819236RE S	2	6	\$11,740	\$13,255
48 x 192x 42" H	Centered	CYA1 4819242RE S	2	6	\$10,360	\$11,875
48 x 192x 42" H	Perimeter	CYA2 4819242RE S	2	6	\$11,830	\$13,345
48 x 240x 29" H	Centered	CYA1 4824029RE S	2	8	\$13,315	\$15,025
48 x 240x 29" H	Perimeter	CYA2 4824029RE S	2	8	\$15,460	\$17,170
48 x 240x 36" H	Centered	CYA1 4824036RE S	2	8	\$13,555	\$15,265
48 x 240x 36" H	Perimeter	CYA2 4824036RE S	2	8	\$15,700	\$17,410
48 x 240x 42" H	Centered	CYA1 4824042RE S	2	8	\$13,675	\$15,385
48 x 240x 42" H	Perimeter	CYA2 4824042RE S	2	8	\$15,820	\$17,530

POWER & A/V OPTIONS SEE PAGES 8-20

TABLE OPTIONS:

Laser cut holes in base - 1.5" x 2.5"

Locking Casters

Industrial Locking Casters

Paper Roll mounted to underside of table top

WB	\$50 list for two bases
CS	\$20 list per caster
CS	\$70 list per caster
ROLL	\$620 list per holder



**FINISHES NEEDED:** <http://hi5furniture.com/finishes/>

HPL Top: Hi5 Graded-in laminates or Non-Premium Wilsonart or Formica

Edge Color: Any Hi5 standard

Base Finish: Any Hi5 standard

NOTE: Raw Tube Steel with Clear Coat [RWT]

Coby Apron legs are tube steel, apron & foot rails are manufactured from sheet metal so Coby Apron bases will be two-toned if ordered in clear coat over raw steel



Table Size	Foot Rail Type	Model Code:	# of Pieces	# of Legs	List Price	List Price
60 x 72x 29" H	None	CYA0 607229RE S	1	4	\$3,790	\$4,370
60 x 72x 29" H	Centered	CYA1 607229RE S	1	4	\$5,445	\$6,025
60 x 72x 29" H	Perimeter	CYA2 607229RE S	1	4	\$6,160	\$6,740
60 x 72x 36" H	None	CYA0 607236RE S	1	4	\$3,910	\$4,490
60 x 72x 36" H	Centered	CYA1 607236RE S	1	4	\$5,565	\$6,145
60 x 72x 36" H	Perimeter	CYA2 607236RE S	1	4	\$6,280	\$6,860
60 x 72x 42" H	None	CYA0 603722RE S	1	4	\$3,970	\$4,550
60 x 72x 42" H	Centered	CYA1 603722RE S	1	4	\$5,625	\$6,205
60 x 72x 42" H	Perimeter	CYA2 603722RE S	1	4	\$6,340	\$6,920
60 x 84x 29" H	Centered	CYA1 608429RE S	1	4	\$5,715	\$6,420
60 x 84x 29" H	Perimeter	CYA2 608429RE S	1	4	\$6,440	\$7,145
60 x 84x 36" H	Centered	CYA1 608436RE S	1	4	\$5,835	\$6,540
60 x 84x 36" H	Perimeter	CYA2 608436RE S	1	4	\$6,560	\$7,265
60 x 84x 42" H	Centered	CYA1 608442RE S	1	4	\$5,895	\$6,600
60 x 84x 42" H	Perimeter	CYA2 608442RE S	1	4	\$6,620	\$7,325
60 x 96x 29" H	Centered	CYA1 609629RE S	1	4	\$5,745	\$6,455
60 x 96x 29" H	Perimeter	CYA2 609629RE S	1	4	\$6,480	\$7,190
60 x 96x 36" H	Centered	CYA1 609636RE S	1	4	\$5,795	\$6,505
60 x 96x 36" H	Perimeter	CYA2 609636RE S	1	4	\$6,600	\$7,310
60 x 96x 42" H	Centered	CYA1 609642RE S	1	4	\$5,925	\$6,635
60 x 96x 42" H	Perimeter	CYA2 609642RE S	1	4	\$6,660	\$7,370

POWER & A/V OPTIONS SEE PAGES 8-20

TABLE OPTIONS:

Laser cut holes in base - 1.5" x 2.5"

Locking Casters

Industrial Locking Casters

Paper Roll mounted to underside of table top

WB

CS

CS

ROLL

\$50 list for two bases

\$20 list per caster

\$70 list per caster

\$620 list per holder



**FINISHES NEEDED:** <http://hi5furniture.com/finishes/>

HPL Top: Hi5 Graded-in laminates or Non-Premium Wilsonart or Formica

Edge Color: Any Hi5 standard

Base Finish: Any Hi5 standard

NOTE: Raw Tube Steel with Clear Coat [RWT]

Coby Apron legs are tube steel, apron & foot rails are manufactured from sheet metal so Coby Apron bases will be two-toned if ordered in clear coat over raw steel



Table Size	Foot Rail Type	Model Code:	# of Pieces	# of Legs	List Price	List Price
60 x 120x 29" H	Centered	CYA1 6012029RE S	1	6	\$8,440	\$9,280
60 x 120x 29" H	Perimeter	CYA2 6012029RE S	1	6	\$9,380	\$10,220
60 x 120x 36" H	Centered	CYA1 6012036RE S	1	6	\$8,620	\$9,460
60 x 120x 36" H	Perimeter	CYA2 6012036RE S	1	6	\$9,560	\$10,400
60 x 120x 42" H	Centered	CYA1 6012042RE S	1	6	\$8,710	\$9,550
60 x 120x 42" H	Perimeter	CYA2 6012042RE S	1	6	\$9,650	\$10,490
60 x 144x 29" H	Centered	CYA1 6014429RE S	2	6	\$10,390	\$11,930
60 x 144x 29" H	Perimeter	CYA2 6014429RE S	2	6	\$11,820	\$13,360
60 x 144x 36" H	Centered	CYA1 6014436RE S	2	6	\$10,570	\$12,110
60 x 144x 36" H	Perimeter	CYA2 6014436RE S	2	6	\$12,000	\$13,540
60 x 144x 42" H	Centered	CYA1 6014442RE S	2	6	\$10,660	\$12,200
60 x 144x 42" H	Perimeter	CYA2 6014442RE S	2	6	\$12,090	\$13,630
60 x 168x 29" H	Centered	CYA1 6016829RE S	2	6	\$10,880	\$12,645
60 x 168x 29" H	Perimeter	CYA2 6016829RE S	2	6	\$12,330	\$14,095
60 x 168x 36" H	Centered	CYA1 6016836RE S	2	6	\$11,060	\$12,825
60 x 168x 36" H	Perimeter	CYA2 6016836RE S	2	6	\$12,510	\$14,275
60 x 168x 42" H	Centered	CYA1 6016842RE S	2	6	\$11,150	\$12,915
60 x 168x 42" H	Perimeter	CYA2 6016842RE S	2	6	\$12,600	\$14,365

POWER & A/V OPTIONS SEE PAGES 8-20

TABLE OPTIONS:

Laser cut holes in base - 1.5" x 2.5"

Locking Casters

Industrial Locking Casters

Paper Roll mounted to underside of table top

WB	\$50 list for two bases
CS	\$20 list per caster
CS	\$70 list per caster
ROLL	\$620 list per holder



**FINISHES NEEDED:** <http://hi5furniture.com/finishes/>

HPL Top: Hi5 Graded-in laminates or Non-Premium Wilsonart or Formica

Edge Color: Any Hi5 standard

Base Finish: Any Hi5 standard

NOTE: Raw Tube Steel with Clear Coat [RWT]

Coby Apron legs are tube steel, apron & foot rails are manufactured from sheet metal so Coby Apron bases will be two-toned if ordered in clear coat over raw steel



Table Size	Foot Rail Type	Model Code:	# of Pieces	# of Legs	List Price	List Price
60 x 192x 29" H	Centered	CYA1 6019229RE S	2	6	\$10,950	\$12,730
60 x 192x 29" H	Perimeter	CYA2 6019229RE S	2	6	\$12,420	\$14,200
60 x 192x 36" H	Centered	CYA1 6019236RE S	2	6	\$11,130	\$12,910
60 x 192x 36" H	Perimeter	CYA2 6019236RE S	2	6	\$12,600	\$14,380
60 x 192x 42" H	Centered	CYA1 6019242RE S	2	6	\$11,220	\$13,000
60 x 192x 42" H	Perimeter	CYA2 6019242RE S	2	6	\$12,690	\$14,470
60 x 240x 29" H	Centered	CYA1 6024029RE S	2	8	\$14,375	\$16,395
60 x 240x 29" H	Perimeter	CYA2 6024029RE S	2	8	\$16,520	\$18,540
60 x 240x 36" H	Centered	CYA1 6024036RE S	2	8	\$14,615	\$16,635
60 x 240x 36" H	Perimeter	CYA2 6024036RE S	2	8	\$16,760	\$18,780
60 x 240x 42" H	Centered	CYA1 6024042RE S	2	8	\$14,735	\$16,755
60 x 240x 42" H	Perimeter	CYA2 6024042RE S	2	8	\$16,880	\$18,900

POWER & A/V OPTIONS SEE PAGES 8-20

TABLE OPTIONS:

Laser cut holes in base - 1.5" x 2.5"

Locking Casters

Industrial Locking Casters

Paper Roll mounted to underside of table top

WB	\$50 list for two bases
CS	\$20 list per caster
CS	\$70 list per caster
ROLL	\$620 list per holder

# Coby Square Model Choices

www.hi5furniture.com Questions? 816-774-4050

March 1, 2018



Code: CYSC  
Square / Post Combo



Code: CYST  
Square Bases



Code: CYSM  
Inset Square / Post Combo



Code: CYP2  
Post Bases

## SEATED HEIGHT

## CAFE HEIGHT

## BAR HEIGHT

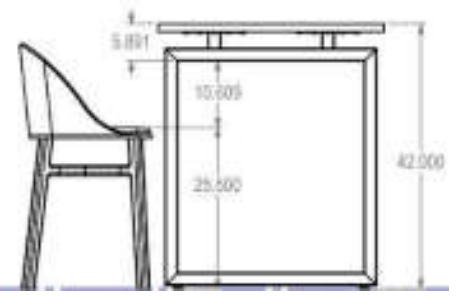
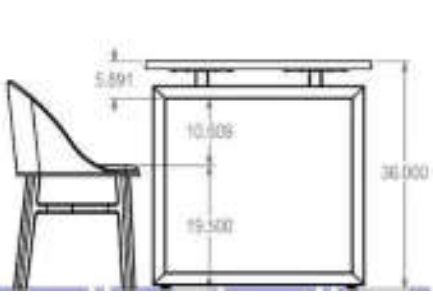
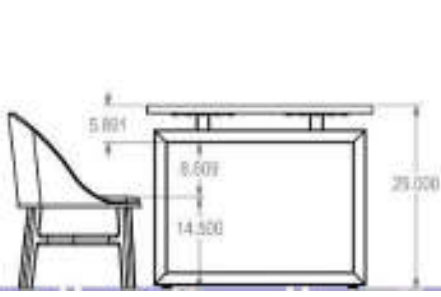

# Coby Square Base Placement

www.hi5furniture.com Questions? 816-774-4050

March 1, 2018

	Square X Code: CYX	Posts Only Code: CYP2
36"		
42"		
48"		
60"		
72"		
84"		
96"		
120"		





# Coby Square Base Placement 24" & 30" Deep

www.hi5furniture.com Questions? 816-774-4050

March 1, 2018

Square Post Combo  
Code: CYSC

Square Bases Only  
Code: CYST

Inset Square Post Combo  
Code: CYSM

Posts Only  
Code: CYP2

42" Long

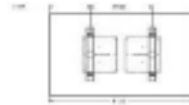
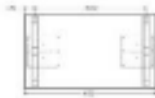

48" Long

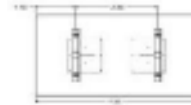

60" Long

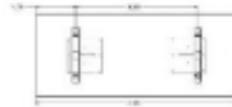

66" Long

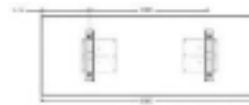

72" Long



84" Long

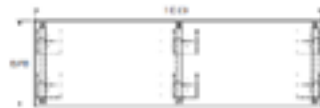

96" Long



108" Long

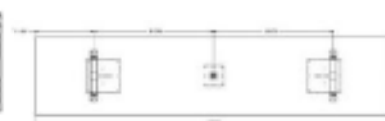
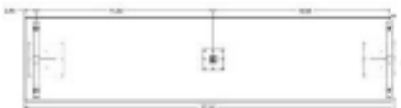

120" Long

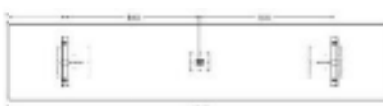
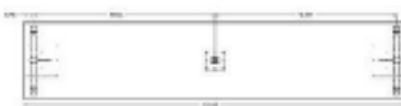

144" Long

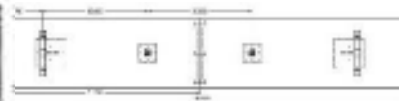
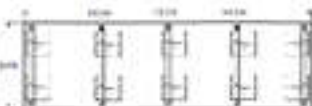

168" long

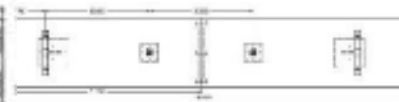
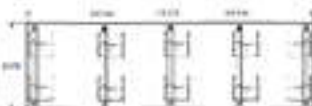



# Coby Square Base Placement 36" & 42" Deep

www.hi5furniture.com Questions? 816-774-4050

March 1, 2018

Square Post Combo  
Code: CYSC

Square Bases Only  
Code: CYST

Inset Square Post Combo  
Code: CYSM

Posts Only  
Code: CYP2

48" Long

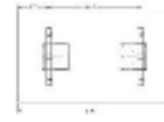
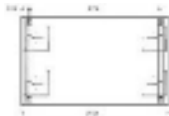

60" Long

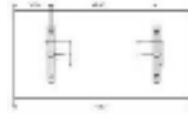

66" Long



72" Long

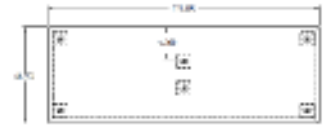

84" Long

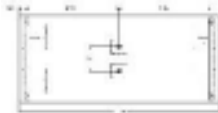

96" Long

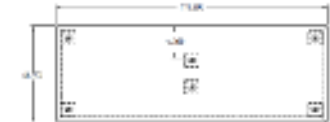
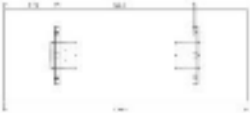
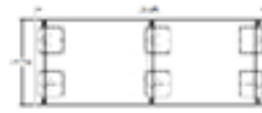
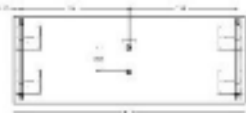

108" Long

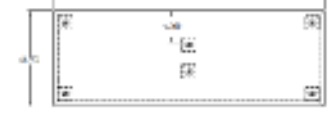
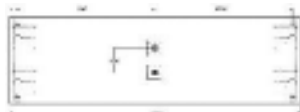

120" Long

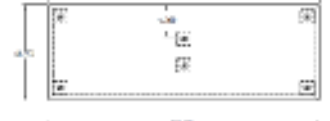
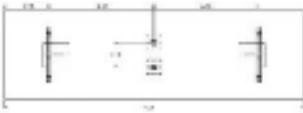
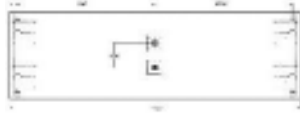

144" Long

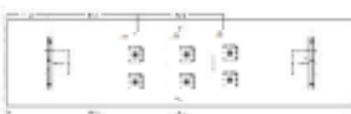
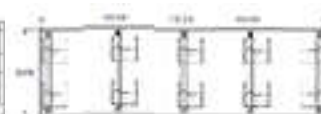

168" Long

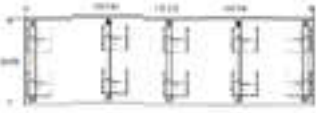

192" Long

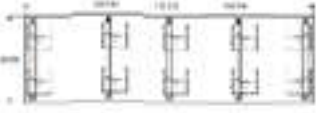
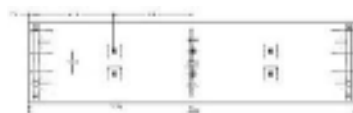

216" Long

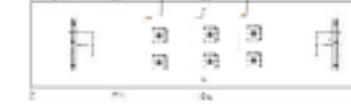

240" Long

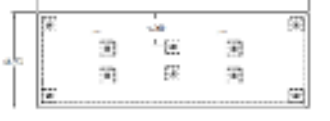
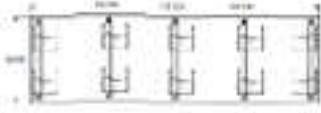
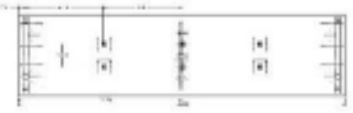

# Coby Square Base Placement 48" & 60" Deep

www.hi5furniture.com Questions? 816-774-4050

March 1, 2018

Square Post Combo  
Code: CYSC

Square Bases Only  
Code: CYST

Inset Square Post Combo  
Code: CYSM

Posts Only  
Code: CYP2

72" Long

84" Long

96" Long

108" Long

120" Long

144" Long

168" Long

192" Long

216" Long

240" Long

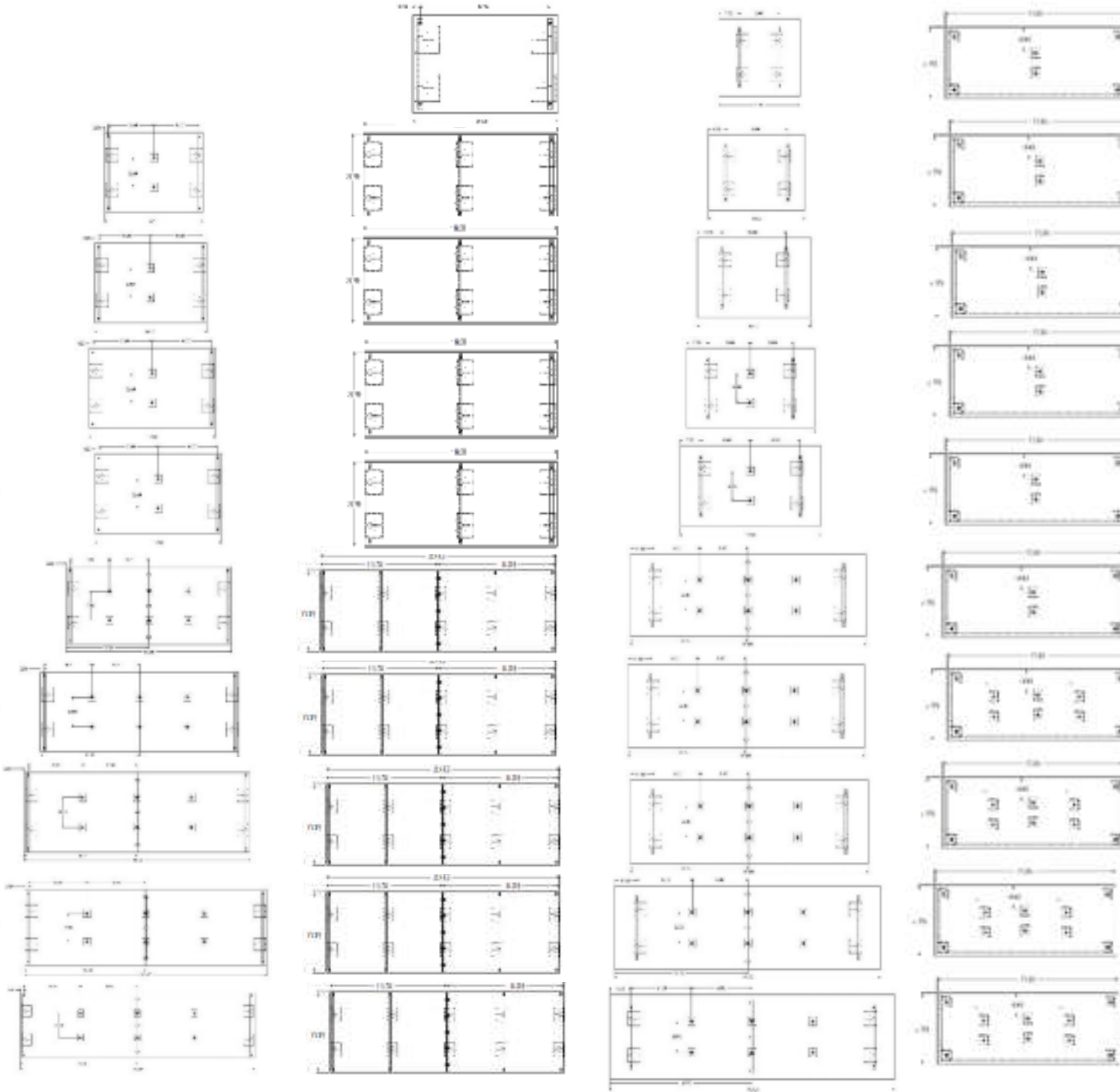

# Coby Square – SQUARE TABLES

www.hi5furniture.com Questions? 816-774-4050

March 1, 2018

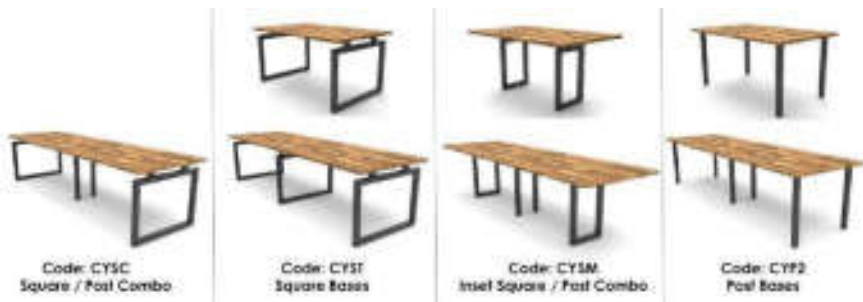

HPL Top Self edges <b>Suffix L6</b>	HPL Top Wood edges <b>Suffix L20</b>	HPL Top Plywood edges <b>Suffix L17</b>	
HPL Top 3mm PVC <b>Suffix L3</b>	HPL Top Knife PVC <b>Suffix L11</b>	HPL Top Knife Wood <b>Suffix L33</b>	HPL Top Knife Plywood <b>Suffix L18</b>

**FINISHES NEEDED:** <http://hi5furniture.com/finishes/>

HPL Top: Hi5 Graded-in laminates or Non-Premium Wilsonart or Formica

Edge Color: Any Hi5 standard

Base Finish: Any Hi5 standard

Table Size	Base Style	Model Code:	# Top Pieces	# of Posts	# of Squares	List Price	List Price	List Price
36 x 36x 29" H	Post Bases	CYP2 364229SQS	1	4	0	\$1,810	\$1,965	\$2,620
36 x 36x 29" H	Square Bases	CYST 364229SQS	1	0	2-36"	\$2,910	\$3,065	\$3,720
36 x 36x 36" H	Post Bases	CYP2 364236SQS	1	4	0	\$1,850	\$2,005	\$2,660
36 x 36x 36" H	Square Bases	CYST 364236SQS	1	0	2-36"	\$3,030	\$3,185	\$3,840
36 x 36x 42" H	Post Bases	CYP2 364242SQS	1	4	0	\$1,890	\$2,045	\$2,700
36 x 36x 42" H	Square Bases	CYST 364242SQS	1	0	2-36"	\$3,150	\$3,305	\$3,960
42 x 42x 29" H	Post Bases	CYP2 364229SQS	1	4	0	\$1,990	\$2,200	\$2,860
42 x 42x 29" H	Square Bases	CYST 364229SQS	1	0	2-42"	\$3,210	\$3,420	\$4,080
42 x 42x 36" H	Post Bases	CYP2 364236SQS	1	4	0	\$2,030	\$2,240	\$2,900
42 x 42x 36" H	Square Bases	CYST 364236SQS	1	0	2-42"	\$3,330	\$3,540	\$4,200
42 x 42x 42" H	Post Bases	CYP2 364242SQS	1	4	0	\$2,070	\$2,280	\$2,940
42 x 42x 42" H	Square Bases	CYST 364242SQS	1	0	2-42"	\$3,450	\$3,660	\$4,320
48 x 48x 29" H	Post Bases	CYP2 364229SQS	1	4	0	\$2,000	\$2,210	\$2,950
48 x 48x 29" H	Square Bases	CYST 364229SQS	1	0	2-48"	\$3,340	\$3,550	\$4,290
48 x 48x 36" H	Post Bases	CYP2 364236SQS	1	4	0	\$2,040	\$2,250	\$2,990
48 x 48x 36" H	Square Bases	CYST 364236SQS	1	0	2-48"	\$3,460	\$3,670	\$4,410
48 x 48x 42" H	Post Bases	CYP2 364242SQS	1	4	0	\$2,080	\$2,290	\$3,030
48 x 48x 42" H	Square Bases	CYST 364242SQS	1	0	2-48"	\$3,580	\$3,790	\$4,530
60 x 60x 29" H	Post Bases	CYP2 364229SQS	1	4	0	\$2,330	\$2,845	\$3,680
60 x 60x 29" H	Square Bases	CYST 364229SQS	1	0	2-60"	\$3,790	\$4,305	\$5,140
60 x 60x 36" H	Post Bases	CYP2 364236SQS	1	4	0	\$2,370	\$2,885	\$3,720
60 x 60x 36" H	Square Bases	CYST 364236SQS	1	0	2-60"	\$3,910	\$4,425	\$5,260
60 x 60x 42" H	Post Bases	CYP2 364242SQS	1	4	0	\$2,410	\$2,925	\$3,760
60 x 60x 42" H	Square Bases	CYST 364242SQS	1	0	2-60"	\$4,030	\$4,545	\$5,380

POWER & A/V OPTIONS SEE PAGES 8-20

**TABLE OPTIONS:**

Laser cut holes in base - 1.5" x 2.5"

Grommet

WB  
G (B | S)

\$100 list per table

\$20 list per table

# Coby Square – 18" deep

www.hi5furniture.com Questions? 816-774-4050

March 1, 2018

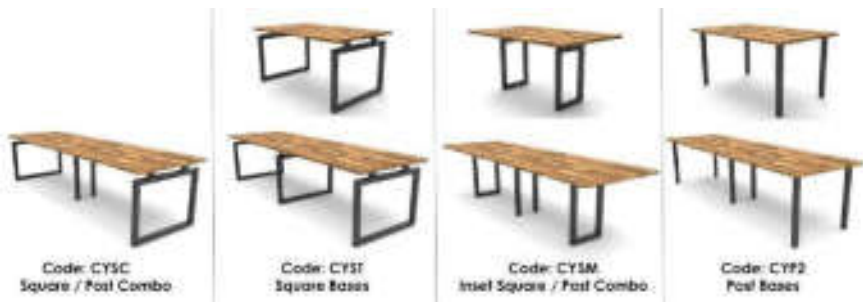

HPL Top Self edges <b>Suffix L6</b>	HPL Top Wood edges <b>Suffix L20</b>	HPL Top Plywood edges <b>Suffix L17</b>	
HPL Top 3mm PVC <b>Suffix L3</b>	HPL Top Knife PVC <b>Suffix L11</b>	HPL Top Knife Wood <b>Suffix L33</b>	HPL Top Knife Plywood <b>Suffix L18</b>

**FINISHES NEEDED:** <http://hi5furniture.com/finishes/>

HPL Top: Hi5 Graded-in laminates or Non-Premium Wilsonart or Formica

Edge Color: Any Hi5 standard

Base Finish: Any Hi5 standard

Table Size	Base Style	Model Code:	# Top Pieces	# of Posts	# of Squares	List Price	List Price	List Price
18 x 42x 29" H	Post Bases	CYP2 184229RES	1	4	0	\$1,740	\$1,875	\$2,480
18 x 42x 29" H	Square Bases	CYST 184229RES	1	0	2-18"	\$2,360	\$2,495	\$3,100
18 x 42x 36" H	Post Bases	CYP2 184236RES	1	4	0	\$1,780	\$1,915	\$2,520
18 x 42x 36" H	Square Bases	CYST 184236RES	1	0	2-18"	\$2,540	\$2,675	\$3,280
18 x 42x 42" H	Post Bases	CYP2 184182RES	1	4	0	\$1,820	\$1,955	\$2,560
18 x 42x 42" H	Square Bases	CYST 184182RES	1	0	2-18"	\$2,720	\$2,855	\$3,460
18 x 48x 29" H	Post Bases	CYP2 184829RES	1	4	0	\$1,740	\$1,875	\$2,530
18 x 48x 29" H	Square Bases	CYST 184829RES	1	0	2-18"	\$2,360	\$2,495	\$3,150
18 x 48x 36" H	Post Bases	CYP2 184836RES	1	4	0	\$1,780	\$1,915	\$2,570
18 x 48x 36" H	Square Bases	CYST 184836RES	1	0	2-18"	\$2,540	\$2,675	\$3,330
18 x 48x 42" H	Post Bases	CYP2 184842RES	1	4	0	\$1,820	\$1,955	\$2,610
18 x 48x 42" H	Square Bases	CYST 184842RES	1	0	2-18"	\$2,720	\$2,855	\$3,510
18 x 60x 29" H	Post Bases	CYP2 186029RES	1	4	Sag Bar	\$1,910	\$2,060	\$2,610
18 x 60x 29" H	Square Bases	CYST 186029RES	1	0	2-18"	\$2,410	\$2,560	\$3,110
18 x 60x 36" H	Post Bases	CYP2 186036RES	1	4	Sag Bar	\$1,950	\$2,100	\$2,650
18 x 60x 36" H	Square Bases	CYST 186036RES	1	0	2-18"	\$2,590	\$2,740	\$3,290
18 x 60x 42" H	Post Bases	CYP2 186042RES	1	4	Sag Bar	\$1,990	\$2,140	\$2,690
18 x 60x 42" H	Square Bases	CYST 186042RES	1	0	2-18"	\$2,770	\$2,920	\$3,470
18 x 66x 29" H	Post Bases	CYP2 186629RES	1	4	Sag Bar	\$1,960	\$2,125	\$2,850
18 x 66x 29" H	Square Bases	CYST 186629RES	1	0	2-18"	\$2,460	\$2,625	\$3,350
18 x 66x 36" H	Post Bases	CYP2 186636RES	1	4	Sag Bar	\$2,000	\$2,165	\$2,890
18 x 66x 36" H	Square Bases	CYST 186636RES	1	0	2-18"	\$2,640	\$2,805	\$3,530
18 x 66x 42" H	Post Bases	CYP2 186642RES	1	4	Sag Bar	\$2,040	\$2,205	\$2,930
18 x 66x 42" H	Square Bases	CYST 186642RES	1	0	2-18"	\$2,820	\$2,985	\$3,710

POWER & A/V OPTIONS SEE PAGES 8-20

TABLE OPTIONS:

Laser cut holes in base - 1.5" x 2.5"

Grommet

WB  
G (B|S)

\$100 list per table

\$20 list per table

# Coby Square – 18" deep

www.hi5furniture.com Questions? 816-774-4050

March 1, 2018

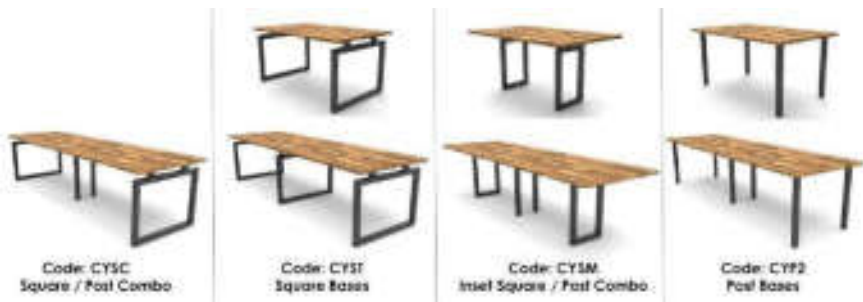

HPL Top Self edges <b>Suffix L6</b>	HPL Top Wood edges <b>Suffix L20</b>	HPL Top Plywood edges <b>Suffix L17</b>	
HPL Top 3mm PVC <b>Suffix L3</b>	HPL Top Knife PVC <b>Suffix L11</b>	HPL Top Knife Wood <b>Suffix L33</b>	HPL Top Knife Plywood <b>Suffix L18</b>

**FINISHES NEEDED:** <http://hi5furniture.com/finishes/>

HPL Top: Hi5 Graded-in laminates or Non-Premium Wilsonart or Formica

Edge Color: Any Hi5 standard

Base Finish: Any Hi5 standard

Table Size	Base Style	Model Code:	# Top Pieces	# of Posts	# of Squares	List Price	List Price	List Price
18 x 72x 29" H	Post Bases	CYP2 187229RES	1	4	Sag Bar	\$2,050	\$2,240	\$2,720
18 x 72x 29" H	Square Bases	CYST 187229RES	1	0	2-18"	\$2,670	\$2,860	\$3,340
18 x 72x 36" H	Post Bases	CYP2 187236RES	1	4	Sag Bar	\$2,090	\$2,280	\$2,760
18 x 72x 36" H	Square Bases	CYST 187236RES	1	0	2-18"	\$2,850	\$3,040	\$3,520
18 x 72x 42" H	Post Bases	CYP2 187182RES	1	4	Sag Bar	\$2,130	\$2,320	\$2,800
18 x 72x 42" H	Square Bases	CYST 187182RES	1	0	2-18"	\$3,030	\$3,220	\$3,700
18 x 84x 29" H	Post Bases	CYP2 188429RES	1	6	0	\$2,800	\$3,020	\$4,060
18 x 84x 29" H	Square/Post Combo	CYSC 188429RES	1	1	2-18"	\$2,975	\$3,195	\$4,235
18 x 84x 29" H	Square Bases	CYST 188429RES	1	0	3-18"	\$3,610	\$3,830	\$4,870
18 x 84x 36" H	Post Bases	CYP2 188436RES	1	6	0	\$2,740	\$2,960	\$4,000
18 x 84x 36" H	Square/Post Combo	CYSC 188436RES	1	1	2-18"	\$3,165	\$3,385	\$4,425
18 x 84x 36" H	Square Bases	CYST 188436RES	1	0	3-18"	\$3,880	\$4,100	\$5,140
18 x 84x 42" H	Post Bases	CYP2 188442RES	1	6	0	\$2,800	\$3,020	\$4,060
18 x 84x 42" H	Square/Post Combo	CYSC 188442RES	1	1	2-18"	\$3,355	\$3,575	\$4,615
18 x 84x 42" H	Square Bases	CYST 188442RES	1	0	3-18"	\$4,150	\$4,370	\$5,410
18 x 96x 29" H	Post Bases	CYP2 189629RES	1	6	0	\$2,700	\$2,925	\$4,030
18 x 96x 29" H	Square/Post Combo	CYSC 189629RES	1	1	2-18"	\$2,995	\$3,220	\$4,325
18 x 96x 29" H	Square Bases	CYST 189629RES	1	0	3-18"	\$3,630	\$3,855	\$4,960
18 x 96x 36" H	Post Bases	CYP2 189636RES	1	6	0	\$2,760	\$2,985	\$4,090
18 x 96x 36" H	Square/Post Combo	CYSC 189636RES	1	1	2-18"	\$3,185	\$3,410	\$4,515
18 x 96x 36" H	Square Bases	CYST 189636RES	1	0	3-18"	\$3,900	\$4,125	\$5,230
18 x 96x 42" H	Post Bases	CYP2 189642RES	1	6	0	\$2,820	\$3,045	\$4,150
18 x 96x 42" H	Square/Post Combo	CYSC 189642RES	1	1	2-18"	\$3,375	\$3,600	\$4,705
18 x 96x 42" H	Square Bases	CYST 189642RES	1	0	3-18"	\$4,170	\$4,395	\$5,500

POWER & A/V OPTIONS SEE PAGES 8-20

**TABLE OPTIONS:**

Laser cut holes in base - 1.5" x 2.5"

Grommet

WB  
G (B | S)

\$100 list per table

\$20 list per table

# Coby Square – 18" deep

www.hi5furniture.com Questions? 816-774-4050

March 1, 2018

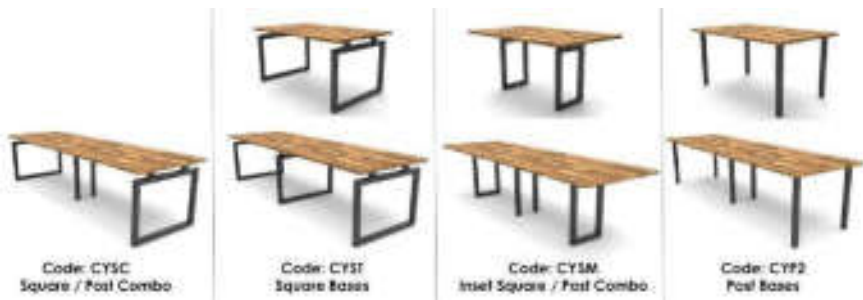

**FINISHES NEEDED:** <http://hi5furniture.com/finishes/>

HPL Top: Hi5 Graded-in laminates or Non-Premium Wilsonart or Formica

Edge Color: Any Hi5 standard

Base Finish: Any Hi5 standard

Table Size	Base Style	Model Code:	# Top Pieces	# of Posts	# of Squares	List Price	List Price	List Price
18 x 108x 29" H	Post Bases	CYP2 1810829RES	1	6	0	\$2,840	\$3,285	\$4,180
18 x 108x 29" H	Square/Post Combo	CYSC 1810829RES	1	1	2-18"	\$3,135	\$3,580	\$4,475
18 x 108x 29" H	Square Bases	CYST 1810829RES	1	0	3-18"	\$3,770	\$4,215	\$5,110
18 x 108x 36" H	Post Bases	CYP2 1810836RES	1	6	0	\$2,900	\$3,345	\$4,240
18 x 108x 36" H	Square/Post Combo	CYSC 1810836RES	1	1	2-18"	\$3,325	\$3,770	\$4,665
18 x 108x 36" H	Square Bases	CYST 1810836RES	1	0	3-18"	\$4,040	\$4,485	\$5,380
18 x 108x 42" H	Post Bases	CYP2 1810842RES	1	6	0	\$2,960	\$3,405	\$4,300
18 x 108x 42" H	Square/Post Combo	CYSC 1810842RES	1	1	2-18"	\$3,515	\$3,960	\$4,855
18 x 108x 42" H	Square Bases	CYST 1810842RES	1	0	3-18"	\$4,310	\$4,755	\$5,650
18 x 120x 29" H	Post Bases	CYP2 1812029RES	1	6	0	\$2,860	\$3,315	\$4,270
18 x 120x 29" H	Square/Post Combo	CYSC 1812029RES	1	1	2-18"	\$3,155	\$3,610	\$4,565
18 x 120x 29" H	Square Bases	CYST 1812029RES	1	0	3-18"	\$3,790	\$4,245	\$5,200
18 x 120x 36" H	Post Bases	CYP2 1812036RES	1	6	0	\$2,920	\$3,375	\$4,330
18 x 120x 36" H	Square/Post Combo	CYSC 1812036RES	1	1	2-18"	\$3,345	\$3,800	\$4,755
18 x 120x 36" H	Square Bases	CYST 1812036RES	1	0	3-18"	\$4,060	\$4,515	\$5,470
18 x 120x 42" H	Post Bases	CYP2 1812042RES	1	6	0	\$2,980	\$3,435	\$4,390
18 x 120x 42" H	Square/Post Combo	CYSC 1812042RES	1	1	2-18"	\$3,535	\$3,990	\$4,945
18 x 120x 42" H	Square Bases	CYST 1812042RES	1	0	3-18"	\$4,330	\$4,785	\$5,740
18 x 144x 29" H	Post Bases	CYP2 1814429RES	2	8	0	\$4,440	\$5,360	\$6,840
18 x 144x 29" H	Square/Post Combo	CYSC 1814429RES	2	3	2-18"	\$4,735	\$5,655	\$7,135
18 x 144x 29" H	Square Bases	CYST 1814429RES	2	0	4-18"	\$5,680	\$6,600	\$8,080
18 x 144x 36" H	Post Bases	CYP2 1814436RES	2	8	0	\$4,520	\$5,440	\$6,920
18 x 144x 36" H	Square/Post Combo	CYSC 1814436RES	2	3	2-18"	\$4,945	\$5,865	\$7,345
18 x 144x 36" H	Square Bases	CYST 1814436RES	2	0	4-18"	\$6,040	\$6,960	\$8,440
18 x 144x 42" H	Post Bases	CYP2 1814442RES	2	8	0	\$4,600	\$5,520	\$7,000
18 x 144x 42" H	Square/Post Combo	CYSC 1814442RES	2	3	2-18"	\$5,155	\$6,075	\$7,555
18 x 144x 42" H	Square Bases	CYST 1814442RES	2	0	4-18"	\$6,400	\$7,320	\$8,800

POWER & A/V OPTIONS SEE PAGES 8-20

**TABLE OPTIONS:**

Laser cut holes in base - 1.5" x 2.5"

Grommet

WB  
G (B|S)

\$100 list per table

\$20 list per table

# Coby Square – 24" deep

www.hi5furniture.com Questions? 816-774-4050

March 1, 2018

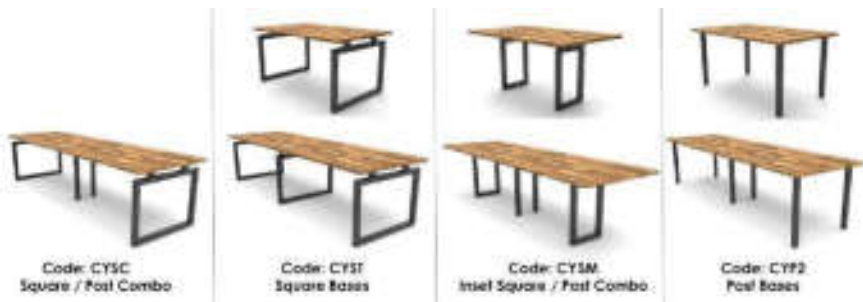

HPL Top Self edges <b>Suffix L6</b>	HPL Top Wood edges <b>Suffix L20</b>	HPL Top Plywood edges <b>Suffix L17</b>	
HPL Top 3mm PVC <b>Suffix L3</b>	HPL Top Knife PVC <b>Suffix L11</b>	HPL Top Knife Wood <b>Suffix L33</b>	HPL Top Knife Plywood <b>Suffix L18</b>

**FINISHES NEEDED:** <http://hi5furniture.com/finishes/>

HPL Top: Hi5 Graded-in laminates or Non-Premium Wilsonart or Formica

Edge Color: Any Hi5 standard

Base Finish: Any Hi5 standard

Table Size	Base Style	Model Code:	# Top Pieces	# of Posts	# of Squares	List Price	List Price	List Price
24 x 42x 29" H	Post Bases	CYP2 244229RES	1	4	0	\$1,770	\$1,915	\$2,550
24 x 42x 29" H	Inset Square	CYSM 244229RES	1	0	2-18"	\$2,390	\$2,535	\$3,170
24 x 42x 29" H	Square Bases	CYST 244229RES	1	0	2-24"	\$2,510	\$2,655	\$3,290
24 x 42x 36" H	Post Bases	CYP2 244236RES	1	4	0	\$1,810	\$1,955	\$2,590
24 x 42x 36" H	Inset Square	CYSM 244236RES	1	0	2-18"	\$2,570	\$2,715	\$3,350
24 x 42x 36" H	Square Bases	CYST 244236RES	1	0	2-24"	\$2,870	\$3,015	\$3,650
24 x 42x 42" H	Post Bases	CYP2 244242RES	1	4	0	\$1,850	\$1,995	\$2,630
24 x 42x 42" H	Inset Square	CYSM 244242RES	1	0	2-18"	\$2,750	\$2,895	\$3,530
24 x 42x 42" H	Square Bases	CYST 244242RES	1	0	2-24"	\$2,870	\$3,015	\$3,650
24 x 48x 29" H	Post Bases	CYP2 244829RES	1	4	0	\$1,780	\$1,925	\$2,600
24 x 48x 29" H	Inset Square	CYSM 244829RES	1	0	2-18"	\$2,400	\$2,545	\$3,220
24 x 48x 29" H	Square Bases	CYST 244829RES	1	0	2-24"	\$2,520	\$2,665	\$3,340
24 x 48x 36" H	Post Bases	CYP2 244836RES	1	4	0	\$1,820	\$1,965	\$2,640
24 x 48x 36" H	Inset Square	CYSM 244836RES	1	0	2-18"	\$2,580	\$2,725	\$3,400
24 x 48x 36" H	Square Bases	CYST 244836RES	1	0	2-24"	\$2,880	\$3,025	\$3,700
24 x 48x 42" H	Post Bases	CYP2 244842RES	1	4	0	\$1,860	\$2,005	\$2,680
24 x 48x 42" H	Inset Square	CYSM 244842RES	1	0	2-18"	\$2,760	\$2,905	\$3,580
24 x 48x 42" H	Square Bases	CYST 244842RES	1	0	2-24"	\$2,880	\$3,025	\$3,700
24 x 60x 29" H	Post Bases	CYP2 246029RES	1	4	Sag Bar	\$1,950	\$2,110	\$2,680
24 x 60x 29" H	Inset Square	CYSM 246029RES	1	0	2-18"	\$2,450	\$2,610	\$3,180
24 x 60x 29" H	Square Bases	CYST 246029RES	1	0	2-24"	\$2,570	\$2,730	\$3,300
24 x 60x 36" H	Post Bases	CYP2 246036RES	1	4	Sag Bar	\$1,990	\$2,150	\$2,720
24 x 60x 36" H	Inset Square	CYSM 246036RES	1	0	2-18"	\$2,630	\$2,790	\$3,360
24 x 60x 36" H	Square Bases	CYST 246036RES	1	0	2-24"	\$2,930	\$3,090	\$3,660
24 x 60x 42" H	Post Bases	CYP2 246042RES	1	4	Sag Bar	\$2,030	\$2,190	\$2,760
24 x 60x 42" H	Inset Square	CYSM 246042RES	1	0	2-18"	\$2,810	\$2,970	\$3,540
24 x 60x 42" H	Square Bases	CYST 246042RES	1	0	2-24"	\$2,930	\$3,090	\$3,660

POWER & A/V OPTIONS SEE PAGES 8-20

**TABLE OPTIONS:**

Laser cut holes in base - 1.5" x 2.5"

Grommet

WB  
G (B|S)

\$100 list per table

\$20 list per table



# Coby Square – 24" deep

www.hi5furniture.com Questions? 816-774-4050

March 1, 2018

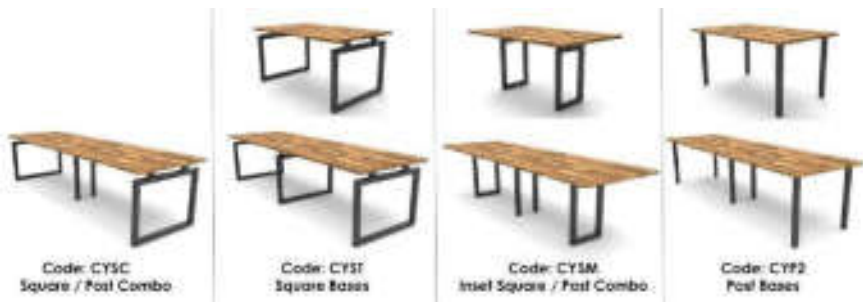

**FINISHES NEEDED:** <http://hi5furniture.com/finishes/>

HPL Top: Hi5 Graded-in laminates or Non-Premium Wilsonart or Formica

Edge Color: Any Hi5 standard

Base Finish: Any Hi5 standard

Table Size	Base Style	Model Code:	# Top Pieces	# of Posts	# of Squares	List Price	List Price	List Price
24 x 66x 29" H	Post Bases	CYP2 246629RES	1	4	Sag Bar	\$2,020	\$2,200	\$2,930
24 x 66x 29" H	Inset Square	CYSM 246629RES	1	0	2-18"	\$2,520	\$2,700	\$3,430
24 x 66x 29" H	Square Bases	CYST 246629RES	1	0	2-24"	\$2,640	\$2,820	\$3,550
24 x 66x 36" H	Post Bases	CYP2 246636RES	1	4	Sag Bar	\$2,060	\$2,240	\$2,970
24 x 66x 36" H	Inset Square	CYSM 246636RES	1	0	2-18"	\$2,700	\$2,880	\$3,610
24 x 66x 36" H	Square Bases	CYST 246636RES	1	Sag Bar	2-24"	\$3,000	\$3,180	\$3,910
24 x 66x 42" H	Post Bases	CYP2 246642RES	1	4	Sag Bar	\$2,100	\$2,280	\$3,010
24 x 66x 42" H	Inset Square	CYSM 246642RES	1	0	2-18"	\$2,880	\$3,060	\$3,790
24 x 66x 42" H	Square Bases	CYST 246642RES	1	Sag Bar	2-24"	\$3,000	\$3,180	\$3,910
24 x 72x 29" H	Post Bases	CYP2 247229RES	1	4	Sag Bar	\$2,120	\$2,330	\$2,810
24 x 72x 29" H	Inset Square	CYSM 247229RES	1	0	2-18"	\$2,620	\$2,830	\$3,310
24 x 72x 29" H	Square Bases	CYST 247229RES	1	Sag Bar	2-24"	\$2,740	\$2,950	\$3,430
24 x 72x 36" H	Post Bases	CYP2 247236RES	1	4	Sag Bar	\$2,160	\$2,370	\$2,850
24 x 72x 36" H	Inset Square	CYSM 247236RES	1	0	2-18"	\$2,800	\$3,010	\$3,490
24 x 72x 36" H	Square Bases	CYST 247236RES	1	Sag Bar	2-24"	\$3,100	\$3,310	\$3,790
24 x 72x 42" H	Post Bases	CYP2 247242RES	1	4	Sag Bar	\$2,200	\$2,410	\$2,890
24 x 72x 42" H	Inset Square	CYSM 247242RES	1	0	2-18"	\$2,980	\$3,190	\$3,670
24 x 72x 42" H	Square Bases	CYST 247242RES	1	Sag Bar	2-24"	\$3,100	\$3,310	\$3,790
24 x 84x 29" H	Post Bases	CYP2 248429RES	1	6	0	\$2,750	\$2,990	\$4,050
24 x 84x 29" H	Square/Post Combo	CYSC 248429RES	1	1	2-24"	\$3,165	\$3,405	\$4,465
24 x 84x 29" H	Inset Square	CYSM 248429RES	1	0	2-18"	\$2,720	\$2,960	\$4,020
24 x 84x 29" H	Square Bases	CYST 248429RES	1	0	3-24"	\$3,860	\$4,100	\$5,160
24 x 84x 36" H	Post Bases	CYP2 248436RES	1	6	0	\$2,810	\$3,050	\$4,110
24 x 84x 36" H	Square/Post Combo	CYSC 248436RES	1	1	2-24"	\$3,355	\$3,595	\$4,655
24 x 84x 36" H	Inset Square	CYSM 248436RES	1	0	2-18"	\$2,900	\$3,140	\$4,200
24 x 84x 36" H	Square Bases	CYST 248436RES	1	0	3-24"	\$4,130	\$4,370	\$5,430

POWER & A/V OPTIONS SEE PAGES 8-20

**TABLE OPTIONS:**

Laser cut holes in base - 1.5" x 2.5"

Grommet

WB  
G (B|S)

\$100 list per table

\$20 list per table

# Coby Square – 24" deep

www.hi5furniture.com Questions? 816-774-4050

March 1, 2018

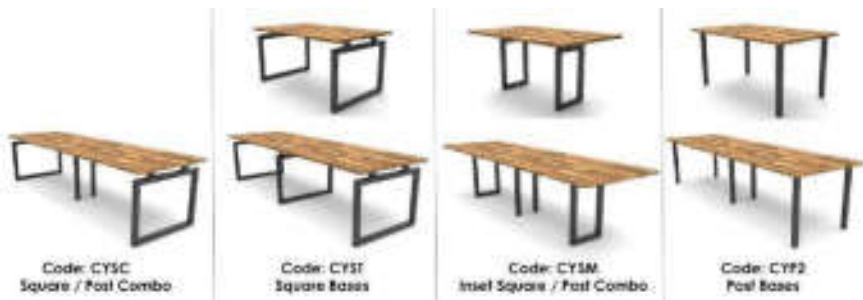

**FINISHES NEEDED:** <http://hi5furniture.com/finishes/>

HPL Top: Hi5 Graded-in laminates or Non-Premium Wilsonart or Formica

Edge Color: Any Hi5 standard

Base Finish: Any Hi5 standard

Table Size	Base Style	Model Code:	# Top Pieces	# of Posts	# of Squares	List Price	List Price	List Price
24 x 84x 42" H	Post Bases	CYP2 248442RES	1	6	0	\$2,870	\$3,110	\$4,170
24 x 84x 42" H	Square/Post Combo	CYSC 248442RES	1	1	2-24"	\$3,545	\$3,785	\$4,845
24 x 84x 42" H	Inset Square	CYSM 248442RES	1	0	2-18"	\$3,080	\$3,320	\$4,380
24 x 84x 42" H	Square Bases	CYST 248442RES	1	0	3-24"	\$4,400	\$4,640	\$5,700
24 x 96x 29" H	Post Bases	CYP2 249629RES	1	6	0	\$2,760	\$3,005	\$4,130
24 x 96x 29" H	Square/Post Combo	CYSC 249629RES	1	1	2-24"	\$3,175	\$3,420	\$4,545
24 x 96x 29" H	Inset Square	CYSM 249629RES	1	0	2-18"	\$2,730	\$2,975	\$4,100
24 x 96x 29" H	Square Bases	CYST 249629RES	1	0	3-24"	\$3,870	\$4,115	\$5,240
24 x 96x 36" H	Post Bases	CYP2 249636RES	1	6	0	\$2,820	\$3,065	\$4,190
24 x 96x 36" H	Square/Post Combo	CYSC 249636RES	1	1	2-24"	\$3,365	\$3,610	\$4,735
24 x 96x 36" H	Inset Square	CYSM 249636RES	1	0	2-18"	\$2,910	\$3,155	\$4,280
24 x 96x 36" H	Square Bases	CYST 249636RES	1	0	3-24"	\$4,140	\$4,385	\$5,510
24 x 96x 42" H	Post Bases	CYP2 249642RES	1	6	0	\$2,880	\$3,125	\$4,250
24 x 96x 42" H	Square/Post Combo	CYSC 249642RES	1	1	2-24"	\$3,555	\$3,800	\$4,925
24 x 96x 42" H	Inset Square	CYSM 249642RES	1	0	2-18"	\$3,090	\$3,335	\$4,460
24 x 96x 42" H	Square Bases	CYST 249642RES	1	0	3-24"	\$4,410	\$4,655	\$5,780
24 x 108x 29" H	Post Bases	CYP2 2410829RES	1	6	0	\$2,870	\$3,330	\$4,300
24 x 108x 29" H	Square/Post Combo	CYSC 2410829RES	1	1	2-24"	\$3,285	\$3,745	\$4,715
24 x 108x 29" H	Inset Combo	CYSM 2410829RES	1	1	2-18"	\$3,165	\$3,625	\$4,595
24 x 108x 29" H	Square Bases	CYST 2410829RES	1	0	3-24"	\$3,980	\$4,440	\$5,410
24 x 108x 36" H	Post Bases	CYP2 2410836RES	1	6	0	\$2,930	\$3,390	\$4,360
24 x 108x 36" H	Square/Post Combo	CYSC 2410836RES	1	1	2-24"	\$3,475	\$3,935	\$4,905
24 x 108x 36" H	Inset Combo	CYSM 2410836RES	1	1	2-18"	\$3,355	\$3,815	\$4,785
24 x 108x 36" H	Square Bases	CYST 2410836RES	1	0	3-24"	\$4,250	\$4,710	\$5,680
24 x 108x 42" H	Post Bases	CYP2 2410842RES	1	6	0	\$2,990	\$3,450	\$4,420
24 x 108x 42" H	Square/Post Combo	CYSC 2410842RES	1	1	2-24"	\$3,665	\$4,125	\$5,095
24 x 108x 42" H	Inset Combo	CYSM 2410842RES	1	1	2-18"	\$3,545	\$4,005	\$4,975
24 x 108x 42" H	Square Bases	CYST 2410842RES	1	0	3-24"	\$4,520	\$4,980	\$5,950

POWER & A/V OPTIONS SEE PAGES 8-20

TABLE OPTIONS:

Laser cut holes in base - 1.5" x 2.5"

Grommet

WB  
G (B|S)

\$100 list per table

\$20 list per table

# Coby Square – 24" deep

www.hi5furniture.com Questions? 816-774-4050

March 1, 2018

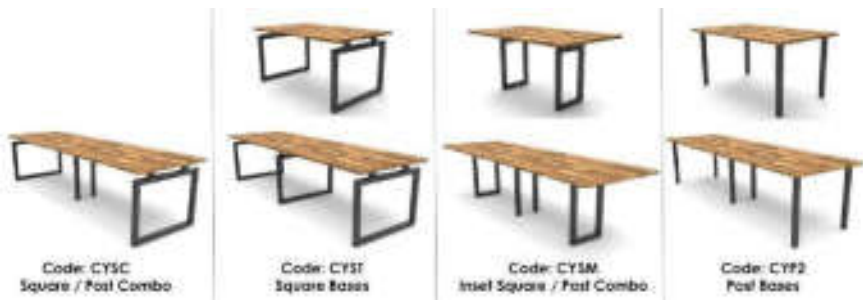

HPL Top Self edges <b>Suffix L6</b>	HPL Top Wood edges <b>Suffix L20</b>	HPL Top Plywood edges <b>Suffix L17</b>	
HPL Top 3mm PVC <b>Suffix L3</b>	HPL Top Knife PVC <b>Suffix L11</b>	HPL Top Knife Wood <b>Suffix L33</b>	HPL Top Knife Plywood <b>Suffix L18</b>

**FINISHES NEEDED:** <http://hi5furniture.com/finishes/>

HPL Top: Hi5 Graded-in laminates or Non-Premium Wilsonart or Formica

Edge Color: Any Hi5 standard

Base Finish: Any Hi5 standard

Table Size	Base Style	Model Code:	# Top Pieces	# of Posts	# of Squares	List Price	List Price	List Price
24 x 120x 29" H	Post Bases	CYP2 2412029RES	1	6	0	\$2,890	\$3,360	\$4,380
24 x 120x 29" H	Square/Post Combo	CYSC 2412029RES	1	1	2-24"	\$3,305	\$3,775	\$4,795
24 x 120x 29" H	Inset Combo	CYSM 2412029RES	1	1	2-18"	\$3,185	\$3,655	\$4,675
24 x 120x 29" H	Square Bases	CYST 2412029RES	1	0	3-24"	\$4,000	\$4,470	\$5,490
24 x 120x 36" H	Post Bases	CYP2 2412036RES	1	6	0	\$2,950	\$3,420	\$4,440
24 x 120x 36" H	Square/Post Combo	CYSC 2412036RES	1	1	2-24"	\$3,495	\$3,965	\$4,985
24 x 120x 36" H	Inset Combo	CYSM 2412036RES	1	1	2-18"	\$3,375	\$3,845	\$4,865
24 x 120x 36" H	Square Bases	CYST 2412036RES	1	0	3-24"	\$4,270	\$4,740	\$5,760
24 x 120x 42" H	Post Bases	CYP2 2412042RES	1	6	0	\$3,010	\$3,480	\$4,500
24 x 120x 42" H	Square/Post Combo	CYSC 2412042RES	1	1	2-24"	\$3,685	\$4,155	\$5,175
24 x 120x 42" H	Inset Combo	CYSM 2412042RES	1	1	2-18"	\$3,565	\$4,035	\$5,055
24 x 120x 42" H	Square Bases	CYST 2412042RES	1	0	3-24"	\$4,540	\$5,010	\$6,030
24 x 144x 29" H	Post Bases	CYP2 2414429RES	2	8	0	\$4,540	\$5,510	\$6,950
24 x 144x 29" H	Square/Post Combo	CYSC 2414429RES	2	3	2-24"	\$4,955	\$5,925	\$7,365
24 x 144x 29" H	Inset Combo	CYSM 2414429RES	2	2	2-18"	\$4,510	\$5,480	\$6,920
24 x 144x 29" H	Square Bases	CYST 2414429RES	2	0	4-24"	\$6,020	\$6,990	\$8,430
24 x 144x 36" H	Post Bases	CYP2 2414436RES	2	8	0	\$4,620	\$5,590	\$7,030
24 x 144x 36" H	Square/Post Combo	CYSC 2414436RES	2	3	2-24"	\$5,165	\$6,135	\$7,575
24 x 144x 36" H	Inset Combo	CYSM 2414436RES	2	2	2-18"	\$4,710	\$5,680	\$7,120
24 x 144x 36" H	Square Bases	CYST 2414436RES	2	0	4-24"	\$6,380	\$7,350	\$8,790
24 x 144x 42" H	Post Bases	CYP2 2414442RES	2	8	0	\$4,700	\$5,670	\$7,110
24 x 144x 42" H	Square/Post Combo	CYSC 2414442RES	2	3	2-24"	\$5,375	\$6,345	\$7,785
24 x 144x 42" H	Inset Combo	CYSM 2414442RES	2	2	2-18"	\$4,910	\$5,880	\$7,320
24 x 144x 42" H	Square Bases	CYST 2414442RES	2	0	4-24"	\$6,740	\$7,710	\$9,150

POWER & A/V OPTIONS SEE PAGES 8-20

**TABLE OPTIONS:**

Laser cut holes in base - 1.5" x 2.5"

Grommet

WB  
G (B|S)

\$100 list per table

\$20 list per table

# Coby Square – 30" deep

www.hi5furniture.com Questions? 816-774-4050

March 1, 2018

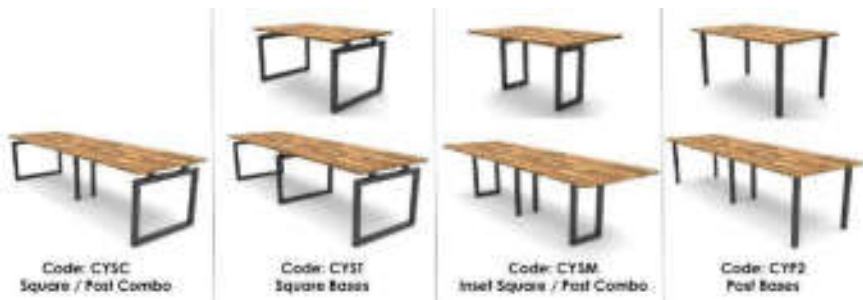

HPL Top Self edges <b>Suffix L6</b>	HPL Top Wood edges <b>Suffix L20</b>	HPL Top Plywood edges <b>Suffix L17</b>	
HPL Top 3mm PVC <b>Suffix L3</b>	HPL Top Knife PVC <b>Suffix L11</b>	HPL Top Knife Wood <b>Suffix L33</b>	HPL Top Knife Plywood <b>Suffix L18</b>

**FINISHES NEEDED:** <http://hi5furniture.com/finishes/>

HPL Top: Hi5 Graded-in laminates or Non-Premium Wilsonart or Formica

Edge Color: Any Hi5 standard

Base Finish: Any Hi5 standard

Table Size	Base Style	Model Code:	# Top Pieces	# of Posts	# of Squares	List Price	List Price	List Price
30 x 42x 29" H	Post Bases	CYP2 304229RES	1	4	0	\$1,830	\$1,990	\$2,640
30 x 42x 29" H	Inset Square	CYSM 304229RES	1	0	2-18"	\$2,450	\$2,610	\$3,260
30 x 42x 29" H	Square Bases	CYST 304229RES	1	0	2-30"	\$2,690	\$2,850	\$3,500
30 x 42x 36" H	Post Bases	CYP2 304236RES	1	4	0	\$1,870	\$2,030	\$2,680
30 x 42x 36" H	Inset Square	CYSM 304236RES	1	0	2-18"	\$2,630	\$2,790	\$3,440
30 x 42x 36" H	Square Bases	CYST 304236RES	1	0	2-30"	\$2,870	\$3,030	\$3,680
30 x 42x 42" H	Post Bases	CYP2 304302RES	1	4	0	\$1,910	\$2,070	\$2,720
30 x 42x 42" H	Inset Square	CYSM 304302RES	1	0	2-18"	\$2,810	\$2,970	\$3,620
30 x 42x 42" H	Square Bases	CYST 304302RES	1	0	2-30"	\$3,050	\$3,210	\$3,860
30 x 48x 29" H	Post Bases	CYP2 304829RES	1	4	0	\$1,840	\$2,005	\$2,680
30 x 48x 29" H	Inset Square	CYSM 304829RES	1	0	2-18"	\$2,460	\$2,625	\$3,300
30 x 48x 29" H	Square Bases	CYST 304829RES	1	0	2-30"	\$2,700	\$2,865	\$3,540
30 x 48x 36" H	Post Bases	CYP2 304836RES	1	4	0	\$1,880	\$2,045	\$2,720
30 x 48x 36" H	Inset Square	CYSM 304836RES	1	0	2-18"	\$2,640	\$2,805	\$3,480
30 x 48x 36" H	Square Bases	CYST 304836RES	1	0	2-30"	\$2,880	\$3,045	\$3,720
30 x 48x 42" H	Post Bases	CYP2 304842RES	1	4	0	\$1,920	\$2,085	\$2,760
30 x 48x 42" H	Inset Square	CYSM 304842RES	1	0	2-18"	\$2,820	\$2,985	\$3,660
30 x 48x 42" H	Square Bases	CYST 304842RES	1	0	2-30"	\$3,060	\$3,225	\$3,900
30 x 60x 29" H	Post Bases	CYP2 306029RES	1	4	Sag Bar	\$2,020	\$2,200	\$2,780
30 x 60x 29" H	Inset Square	CYSM 306029RES	1	0	2-18"	\$2,520	\$2,700	\$3,280
30 x 60x 29" H	Square Bases	CYST 306029RES	1	0	2-30"	\$2,760	\$2,940	\$3,520
30 x 60x 36" H	Post Bases	CYP2 306036RES	1	4	Sag Bar	\$2,060	\$2,240	\$2,820
30 x 60x 36" H	Inset Square	CYSM 306036RES	1	0	2-18"	\$2,700	\$2,880	\$3,460
30 x 60x 36" H	Square Bases	CYST 306036RES	1	0	2-30"	\$2,940	\$3,120	\$3,700
30 x 60x 42" H	Post Bases	CYP2 306042RES	1	4	Sag Bar	\$2,100	\$2,280	\$2,860
30 x 60x 42" H	Inset Square	CYSM 306042RES	1	0	2-18"	\$2,880	\$3,060	\$3,640
30 x 60x 42" H	Square Bases	CYST 306042RES	1	0	2-30"	\$3,120	\$3,300	\$3,880

POWER & A/V OPTIONS SEE PAGES 8-20

**TABLE OPTIONS:**

Laser cut holes in base - 1.5" x 2.5"

Grommet

WB  
G (B | S)

\$100 list per table

\$20 list per table

# Coby Square – 30" deep

www.hi5furniture.com Questions? 816-774-4050

March 1, 2018

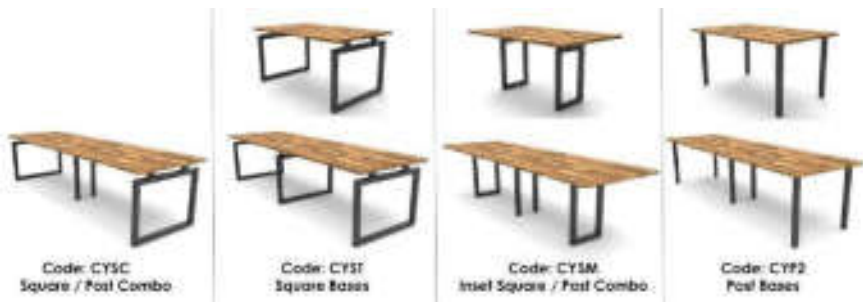

HPL Top Self edges <b>Suffix L6</b>	HPL Top Wood edges <b>Suffix L20</b>	HPL Top Plywood edges <b>Suffix L17</b>	
HPL Top 3mm PVC <b>Suffix L3</b>	HPL Top Knife PVC <b>Suffix L11</b>	HPL Top Knife Wood <b>Suffix L33</b>	HPL Top Knife Plywood <b>Suffix L18</b>

**FINISHES NEEDED:** <http://hi5furniture.com/finishes/>

HPL Top: Hi5 Graded-in laminates or Non-Premium Wilsonart or Formica

Edge Color: Any Hi5 standard

Base Finish: Any Hi5 standard

Table Size	Base Style	Model Code:	# Top Pieces	# of Posts	# of Squares	List Price	List Price	List Price
30 x 66x 29" H	Post Bases	CYP2 306629RES	1	4	Sag Bar	\$2,090	\$2,295	\$3,050
30 x 66x 29" H	Inset Square	CYSM 306629RES	1	0	2-18"	\$2,590	\$2,795	\$3,550
30 x 66x 29" H	Square Bases	CYST 306629RES	1	Sag Bar	2-30"	\$2,950	\$3,155	\$3,910
30 x 66x 36" H	Post Bases	CYP2 306636RES	1	4	Sag Bar	\$2,130	\$2,335	\$3,090
30 x 66x 36" H	Inset Square	CYSM 306636RES	1	0	2-18"	\$2,770	\$2,975	\$3,730
30 x 66x 36" H	Square Bases	CYST 306636RES	1	Sag Bar	2-30"	\$3,130	\$3,335	\$4,090
30 x 66x 42" H	Post Bases	CYP2 306642RES	1	4	Sag Bar	\$2,170	\$2,375	\$3,130
30 x 66x 42" H	Inset Square	CYSM 306642RES	1	0	2-18"	\$2,950	\$3,155	\$3,910
30 x 66x 42" H	Square Bases	CYST 306642RES	1	Sag Bar	2-30"	\$3,310	\$3,515	\$4,270
30 x 72x 29" H	Post Bases	CYP2 307229RES	1	4	Sag Bar	\$2,200	\$2,435	\$2,910
30 x 72x 29" H	Inset Square	CYSM 307229RES	1	0	2-18"	\$2,700	\$2,935	\$3,410
30 x 72x 29" H	Square Bases	CYST 307229RES	1	Sag Bar	2-30"	\$3,060	\$3,295	\$3,770
30 x 72x 36" H	Post Bases	CYP2 307236RES	1	4	Sag Bar	\$2,240	\$2,475	\$2,950
30 x 72x 36" H	Inset Square	CYSM 307236RES	1	0	2-18"	\$2,880	\$3,115	\$3,590
30 x 72x 36" H	Square Bases	CYST 307236RES	1	Sag Bar	2-30"	\$3,240	\$3,475	\$3,950
30 x 72x 42" H	Post Bases	CYP2 307302RES	1	4	Sag Bar	\$2,280	\$2,515	\$2,990
30 x 72x 42" H	Inset Square	CYSM 307302RES	1	0	2-18"	\$3,060	\$3,295	\$3,770
30 x 72x 42" H	Square Bases	CYST 307302RES	1	Sag Bar	2-30"	\$3,420	\$3,655	\$4,130
30 x 84x 29" H	Post Bases	CYP2 308429RES	1	6	0	\$2,850	\$3,120	\$4,180
30 x 84x 29" H	Square/Post Combo	CYSC 308429RES	1	1	2-30"	\$3,385	\$3,655	\$4,715
30 x 84x 29" H	Inset Square	CYSM 308429RES	1	0	2-18"	\$2,820	\$3,090	\$4,150
30 x 84x 29" H	Square Bases	CYST 308429RES	1	0	3-30"	\$4,140	\$4,410	\$5,470
30 x 84x 36" H	Post Bases	CYP2 308436RES	1	6	0	\$2,910	\$3,180	\$4,240
30 x 84x 36" H	Square/Post Combo	CYSC 308436RES	1	1	2-30"	\$3,575	\$3,845	\$4,905
30 x 84x 36" H	Inset Square	CYSM 308436RES	1	0	2-18"	\$3,000	\$3,270	\$4,330
30 x 84x 36" H	Square Bases	CYST 308436RES	1	0	3-30"	\$4,410	\$4,680	\$5,740

POWER & A/V OPTIONS SEE PAGES 8-20

**TABLE OPTIONS:**

Laser cut holes in base - 1.5" x 2.5"

Grommet

WB  
G (B|S)

\$100 list per table

\$20 list per table

# Coby Square – 30" deep

www.hi5furniture.com Questions? 816-774-4050

March 1, 2018

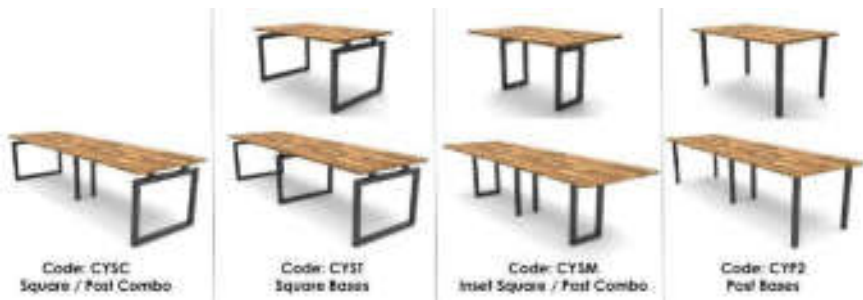

HPL Top Self edges <b>Suffix L6</b>	HPL Top Wood edges <b>Suffix L20</b>	HPL Top Plywood edges <b>Suffix L17</b>	
HPL Top 3mm PVC <b>Suffix L3</b>	HPL Top Knife PVC <b>Suffix L11</b>	HPL Top Knife Wood <b>Suffix L33</b>	HPL Top Knife Plywood <b>Suffix L18</b>

**FINISHES NEEDED:** <http://hi5furniture.com/finishes/>

HPL Top: Hi5 Graded-in laminates or Non-Premium Wilsonart or Formica

Edge Color: Any Hi5 standard

Base Finish: Any Hi5 standard

Table Size	Base Style	Model Code:	# Top Pieces	# of Posts	# of Squares	List Price	List Price	List Price
30 x 84x 42" H	Post Bases	CYP2 308442RES	1	6	0	\$2,970	\$3,240	\$4,300
30 x 84x 42" H	Square/Post Combo	CYSC 308442RES	1	1	2-30"	\$3,765	\$4,035	\$5,095
30 x 84x 42" H	Inset Square	CYSM 308442RES	1	0	2-18"	\$3,180	\$3,450	\$4,510
30 x 84x 42" H	Square Bases	CYST 308442RES	1	0	3-30"	\$4,680	\$4,950	\$6,010
30 x 96x 29" H	Post Bases	CYP2 309629RES	1	6	0	\$2,860	\$3,135	\$4,260
30 x 96x 29" H	Square/Post Combo	CYSC 309629RES	1	1	2-30"	\$3,395	\$3,670	\$4,795
30 x 96x 29" H	Inset Square	CYSM 309629RES	1	0	2-18"	\$2,830	\$3,105	\$4,230
30 x 96x 29" H	Square Bases	CYST 309629RES	1	0	3-30"	\$4,150	\$4,425	\$5,550
30 x 96x 36" H	Post Bases	CYP2 309636RES	1	6	0	\$2,920	\$3,195	\$4,320
30 x 96x 36" H	Square/Post Combo	CYSC 309636RES	1	1	2-30"	\$3,585	\$3,860	\$4,985
30 x 96x 36" H	Inset Square	CYSM 309636RES	1	0	2-18"	\$3,010	\$3,285	\$4,410
30 x 96x 36" H	Square Bases	CYST 309636RES	1	0	3-30"	\$4,420	\$4,695	\$5,820
30 x 96x 42" H	Post Bases	CYP2 309642RES	1	6	0	\$2,980	\$3,255	\$4,380
30 x 96x 42" H	Square/Post Combo	CYSC 309642RES	1	1	2-30"	\$3,775	\$4,050	\$5,175
30 x 96x 42" H	Inset Square	CYSM 309642RES	1	0	2-18"	\$3,190	\$3,465	\$4,590
30 x 96x 42" H	Square Bases	CYST 309642RES	1	0	3-30"	\$4,690	\$4,965	\$6,090
30 x 108x 29" H	Post Bases	CYP2 3010829RES	1	6	0	\$3,000	\$3,525	\$4,460
30 x 108x 29" H	Square/Post Combo	CYSC 3010829RES	1	1	2-30"	\$3,535	\$4,060	\$4,995
30 x 108x 29" H	Inset Combo	CYSM 3010829RES	1	1	2-18"	\$3,295	\$3,820	\$4,755
30 x 108x 29" H	Square Bases	CYST 3010829RES	1	0	3-30"	\$4,290	\$4,815	\$5,750
30 x 108x 36" H	Post Bases	CYP2 3010836RES	1	6	0	\$3,060	\$3,585	\$4,520
30 x 108x 36" H	Square/Post Combo	CYSC 3010836RES	1	1	2-30"	\$3,725	\$4,250	\$5,185
30 x 108x 36" H	Inset Combo	CYSM 3010836RES	1	1	2-18"	\$3,485	\$4,010	\$4,945
30 x 108x 36" H	Square Bases	CYST 3010836RES	1	0	3-30"	\$4,560	\$5,085	\$6,020
30 x 108x 42" H	Post Bases	CYP2 3010842RES	1	6	0	\$3,120	\$3,645	\$4,580
30 x 108x 42" H	Square/Post Combo	CYSC 3010842RES	1	1	2-30"	\$3,915	\$4,440	\$5,375
30 x 108x 42" H	Inset Combo	CYSM 3010842RES	1	1	2-18"	\$3,675	\$4,200	\$5,135
30 x 108x 42" H	Square Bases	CYST 3010842RES	1	0	3-30"	\$4,830	\$5,355	\$6,290

POWER & A/V OPTIONS SEE PAGES 8-20

**TABLE OPTIONS:**

Laser cut holes in base - 1.5" x 2.5"

Grommet

WB  
G (B|S)

\$100 list per table

\$20 list per table

# Coby Square – 30" deep

www.hi5furniture.com Questions? 816-774-4050

March 1, 2018

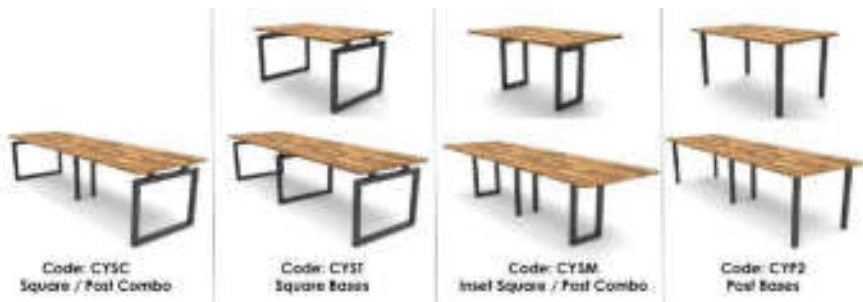

**FINISHES NEEDED:** <http://hi5furniture.com/finishes/>

HPL Top: Hi5 Graded-in laminates or Non-Premium Wilsonart or Formica

Edge Color: Any Hi5 standard

Base Finish: Any Hi5 standard

Table Size	Base Style	Model Code:	# Top Pieces	# of Posts	# of Squares	List Price	List Price	List Price
30 x 120x 29" H	Post Bases	CYP2 3012029RES	1	6	0	\$3,010	\$3,540	\$4,540
30 x 120x 29" H	Square/Post Combo	CYSC 3012029RES	1	1	2-30"	\$3,545	\$4,075	\$5,075
30 x 120x 29" H	Inset Combo	CYSM 3012029RES	1	1	2-18"	\$3,305	\$3,835	\$4,835
30 x 120x 29" H	Square Bases	CYST 3012029RES	1	0	3-30"	\$4,300	\$4,830	\$5,830
30 x 120x 36" H	Post Bases	CYP2 3012036RES	1	6	0	\$3,070	\$3,600	\$4,600
30 x 120x 36" H	Square/Post Combo	CYSC 3012036RES	1	1	2-30"	\$3,735	\$4,265	\$5,265
30 x 120x 36" H	Inset Combo	CYSM 3012036RES	1	1	2-18"	\$3,495	\$4,025	\$5,025
30 x 120x 36" H	Square Bases	CYST 3012036RES	1	0	3-30"	\$4,570	\$5,100	\$6,100
30 x 120x 42" H	Post Bases	CYP2 3012042RES	1	6	0	\$3,130	\$3,660	\$4,660
30 x 120x 42" H	Square/Post Combo	CYSC 3012042RES	1	1	2-30"	\$3,925	\$4,455	\$5,455
30 x 120x 42" H	Inset Combo	CYSM 3012042RES	1	1	2-18"	\$3,685	\$4,215	\$5,215
30 x 120x 42" H	Square Bases	CYST 3012042RES	1	0	3-30"	\$4,840	\$5,370	\$6,370
30 x 132x 29" H	Post Bases	CYP2 3013229RES	2	8	0	\$4,700	\$5,750	\$7,000
30 x 132x 29" H	Square/Post Combo	CYSC 3013229RES	2	3	2-30"	\$5,235	\$6,285	\$7,535
30 x 132x 29" H	Inset Combo	CYSM 3013229RES	2	2	2-18"	\$4,670	\$5,720	\$6,970
30 x 132x 29" H	Square Bases	CYST 3013229RES	2	0	5-30"	\$7,500	\$8,550	\$9,800
30 x 132x 36" H	Post Bases	CYP2 3013236RES	2	8	0	\$4,780	\$5,830	\$7,080
30 x 132x 36" H	Square/Post Combo	CYSC 3013236RES	2	3	2-30"	\$5,445	\$6,495	\$7,745
30 x 132x 36" H	Inset Combo	CYSM 3013236RES	2	2	2-18"	\$4,870	\$5,920	\$7,170
30 x 132x 36" H	Square Bases	CYST 3013236RES	2	0	5-30"	\$7,950	\$9,000	\$10,250
30 x 132x 42" H	Post Bases	CYP2 3013242RES	2	8	0	\$4,860	\$5,910	\$7,160
30 x 132x 42" H	Square/Post Combo	CYSC 3013242RES	2	3	2-30"	\$5,655	\$6,705	\$7,955
30 x 132x 42" H	Inset Combo	CYSM 3013242RES	2	2	2-18"	\$5,070	\$6,120	\$7,370
30 x 132x 42" H	Square Bases	CYST 3013242RES	2	0	5-30"	\$8,400	\$9,450	\$10,700

POWER & A/V OPTIONS SEE PAGES 8-20

**TABLE OPTIONS:**

Laser cut holes in base - 1.5" x 2.5"

Grommet

WB  
G (B|S)

\$100 list per table





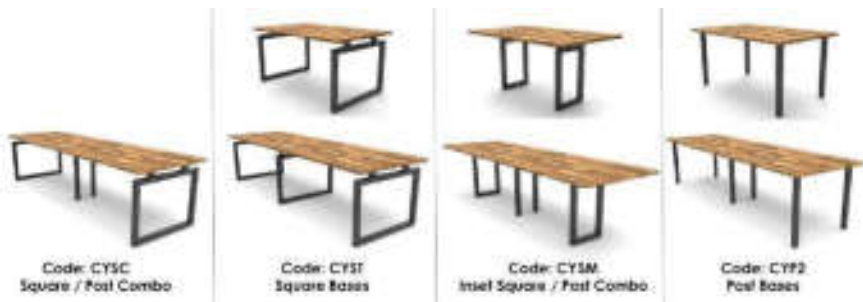

\$20 list per table

# Coby Square – 30" deep

www.hi5furniture.com Questions? 816-774-4050

March 1, 2018



 HPL Top Self edges <b>Suffix L6</b>	 HPL Top Wood edges <b>Suffix L20</b>	 HPL Top Plywood edges <b>Suffix L17</b>	
 HPL Top 3mm PVC <b>Suffix L3</b>	 HPL Top Knife PVC <b>Suffix L11</b>	 HPL Top Knife Wood <b>Suffix L33</b>	 HPL Top Knife Plywood <b>Suffix L18</b>

**FINISHES NEEDED:** <http://hi5furniture.com/finishes/>

HPL Top: Hi5 Graded-in laminates or Non-Premium Wilsonart or Formica

Edge Color: Any Hi5 standard

Base Finish: Any Hi5 standard

Table Size	Base Style	Model Code:	# Top Pieces	# of Posts	# of Squares	List Price	List Price	List Price
30 x 144x 29" H	Post Bases	CYP2 3014429RES	2	8	0	\$4,750	\$5,825	\$7,270
30 x 144x 29" H	Square/Post Combo	CYSC 3014429RES	2	3	2-30"	\$5,285	\$6,360	\$7,805
30 x 144x 29" H	Inset Combo	CYSM 3014429RES	2	2	2-18"	\$4,720	\$5,795	\$7,240
30 x 144x 29" H	Square Bases	CYST 3014429RES	2	0	5-30"	\$7,550	\$8,625	\$10,070
30 x 144x 36" H	Post Bases	CYP2 3014436RES	2	8	0	\$4,830	\$5,905	\$7,350
30 x 144x 36" H	Square/Post Combo	CYSC 3014436RES	2	3	2-30"	\$5,495	\$6,570	\$8,015
30 x 144x 36" H	Inset Combo	CYSM 3014436RES	2	2	2-18"	\$4,920	\$5,995	\$7,440
30 x 144x 36" H	Square Bases	CYST 3014436RES	2	0	5-30"	\$8,000	\$9,075	\$10,520
30 x 144x 42" H	Post Bases	CYP2 3014442RES	2	8	0	\$4,910	\$5,985	\$7,430
30 x 144x 42" H	Square/Post Combo	CYSC 3014442RES	2	3	2-30"	\$5,705	\$6,780	\$8,225
30 x 144x 42" H	Inset Combo	CYSM 3014442RES	2	2	2-18"	\$5,120	\$6,195	\$7,640
30 x 144x 42" H	Square Bases	CYST 3014442RES	2	0	5-30"	\$8,450	\$9,525	\$10,970
30 x 168x 29" H	Post Bases	CYP2 3016829RES	2	10	0	\$5,640	\$6,835	\$8,280
30 x 168x 29" H	Square/Post Combo	CYSC 3016829RES	2	3	2-30"	\$5,525	\$6,720	\$8,165
30 x 168x 29" H	Inset Combo	CYSM 3016829RES	2	2	2-18"	\$4,960	\$6,155	\$7,600
30 x 168x 29" H	Square Bases	CYST 3016829RES	2	0	5-30"	\$7,790	\$8,985	\$10,430
30 x 168x 36" H	Post Bases	CYP2 3016836RES	2	10	0	\$5,740	\$6,935	\$8,380
30 x 168x 36" H	Square/Post Combo	CYSC 3016836RES	2	3	2-30"	\$5,735	\$6,930	\$8,375
30 x 168x 36" H	Inset Combo	CYSM 3016836RES	2	2	2-18"	\$5,160	\$6,355	\$7,800
30 x 168x 36" H	Square Bases	CYST 3016836RES	2	0	5-30"	\$8,240	\$9,435	\$10,880
30 x 168x 42" H	Post Bases	CYP2 3016842RES	2	10	0	\$5,840	\$7,035	\$8,480
30 x 168x 42" H	Square/Post Combo	CYSC 3016842RES	2	3	2-30"	\$5,945	\$7,140	\$8,585
30 x 168x 42" H	Inset Combo	CYSM 3016842RES	2	2	2-18"	\$5,360	\$6,555	\$8,000
30 x 168x 42" H	Square Bases	CYST 3016842RES	2	0	5-30"	\$8,690	\$9,885	\$11,330

POWER & A/V OPTIONS SEE PAGES 8-20

**TABLE OPTIONS:**

Laser cut holes in base - 1.5" x 2.5"

Grommet

WB  
G (B|S)

\$100 list per table

\$20 list per table



# Coby Square – 36" deep

www.hi5furniture.com Questions? 816-774-4050

March 1, 2018

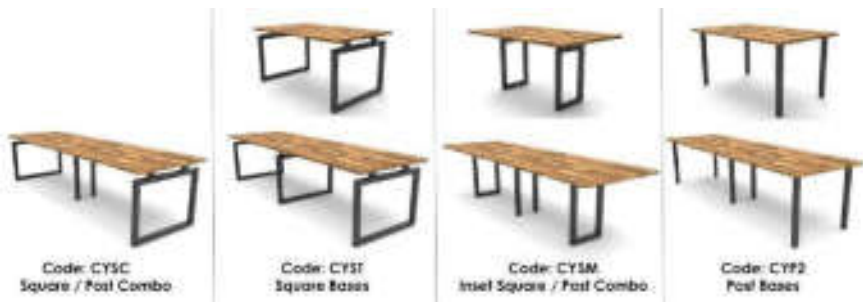

HPL Top Self edges <b>Suffix L6</b>	HPL Top Wood edges <b>Suffix L20</b>	HPL Top Plywood edges <b>Suffix L17</b>	
HPL Top 3mm PVC <b>Suffix L3</b>	HPL Top Knife PVC <b>Suffix L11</b>	HPL Top Knife Wood <b>Suffix L33</b>	HPL Top Knife Plywood <b>Suffix L18</b>

**FINISHES NEEDED:** <http://hi5furniture.com/finishes/>

HPL Top: Hi5 Graded-in laminates or Non-Premium Wilsonart or Formica

Edge Color: Any Hi5 standard

Base Finish: Any Hi5 standard

Table Size	Base Style	Model Code:	# Top Pieces	# of Posts	# of Squares	List Price	List Price	List Price
36 x 42x 29" H	Post Bases	CYP2 364229RES	1	4	0	\$1,880	\$2,055	\$2,730
36 x 42x 29" H	Inset Square	CYSM 364229RES	1	0	2-18"	\$2,500	\$2,675	\$3,350
36 x 42x 29" H	Square Bases	CYST 364229RES	1	0	2-36"	\$2,980	\$3,155	\$3,830
36 x 42x 36" H	Post Bases	CYP2 364236RES	1	4	0	\$1,920	\$2,095	\$2,770
36 x 42x 36" H	Inset Square	CYSM 364236RES	1	0	2-18"	\$2,680	\$2,855	\$3,530
36 x 42x 36" H	Square Bases	CYST 364236RES	1	0	2-36"	\$3,100	\$3,275	\$3,950
36 x 42x 42" H	Post Bases	CYP2 364362RES	1	4	0	\$1,960	\$2,135	\$2,810
36 x 42x 42" H	Inset Square	CYSM 364362RES	1	0	2-18"	\$2,860	\$3,035	\$3,710
36 x 42x 42" H	Square Bases	CYST 364362RES	1	0	2-36"	\$3,220	\$3,395	\$4,070
36 x 48x 29" H	Post Bases	CYP2 364829RES	1	4	0	\$1,890	\$2,070	\$2,780
36 x 48x 29" H	Inset Square	CYSM 364829RES	1	0	2-18"	\$2,510	\$2,690	\$3,400
36 x 48x 29" H	Square Bases	CYST 364829RES	1	0	2-36"	\$2,990	\$3,170	\$3,880
36 x 48x 36" H	Post Bases	CYP2 364836RES	1	4	0	\$1,930	\$2,110	\$2,820
36 x 48x 36" H	Inset Square	CYSM 364836RES	1	0	2-18"	\$2,690	\$2,870	\$3,580
36 x 48x 36" H	Square Bases	CYST 364836RES	1	0	2-36"	\$3,110	\$3,290	\$4,000
36 x 48x 42" H	Post Bases	CYP2 364842RES	1	4	0	\$1,970	\$2,150	\$2,860
36 x 48x 42" H	Inset Square	CYSM 364842RES	1	0	2-18"	\$2,870	\$3,050	\$3,760
36 x 48x 42" H	Square Bases	CYST 364842RES	1	0	2-36"	\$3,230	\$3,410	\$4,120
36 x 60x 29" H	Post Bases	CYP2 366029RES	1	4	Sag Bar	\$2,090	\$2,295	\$3,050
36 x 60x 29" H	Inset Square	CYSM 366029RES	1	0	2-18"	\$2,590	\$2,795	\$3,550
36 x 60x 29" H	Square Bases	CYST 366029RES	1	0	2-36"	\$3,070	\$3,275	\$4,030
36 x 60x 36" H	Post Bases	CYP2 366036RES	1	4	Sag Bar	\$2,130	\$2,335	\$3,090
36 x 60x 36" H	Inset Square	CYSM 366036RES	1	0	2-18"	\$2,770	\$2,975	\$3,730
36 x 60x 36" H	Square Bases	CYST 366036RES	1	0	2-36"	\$3,190	\$3,395	\$4,150
36 x 60x 42" H	Post Bases	CYP2 366042RES	1	4	Sag Bar	\$2,170	\$2,375	\$3,130
36 x 60x 42" H	Inset Square	CYSM 366042RES	1	0	2-18"	\$2,950	\$3,155	\$3,910
36 x 60x 42" H	Square Bases	CYST 366042RES	1	0	2-36"	\$3,310	\$3,515	\$4,270

POWER & A/V OPTIONS SEE PAGES 8-20

TABLE OPTIONS:

Laser cut holes in base - 1.5" x 2.5"

Grommet

WB  
G (B|S)

\$100 list per table

\$20 list per table

# Coby Square – 36" deep

www.hi5furniture.com Questions? 816-774-4050

March 1, 2018

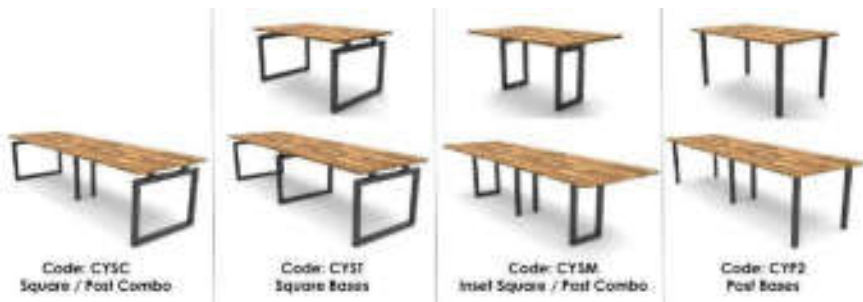

HPL Top Self edges <b>Suffix L6</b>	HPL Top Wood edges <b>Suffix L20</b>	HPL Top Plywood edges <b>Suffix L17</b>	
HPL Top 3mm PVC <b>Suffix L3</b>	HPL Top Knife PVC <b>Suffix L11</b>	HPL Top Knife Wood <b>Suffix L33</b>	HPL Top Knife Plywood <b>Suffix L18</b>

**FINISHES NEEDED:** <http://hi5furniture.com/finishes/>

HPL Top: Hi5 Graded-in laminates or Non-Premium Wilsonart or Formica

Edge Color: Any Hi5 standard

Base Finish: Any Hi5 standard

Table Size	Base Style	Model Code:	# Top Pieces	# of Posts	# of Squares	List Price	List Price	List Price
36 x 66x 29" H	Post Bases	CYP2 366629RES	1	4	Sag Bar	\$2,260	\$2,515	\$3,520
36 x 66x 29" H	Inset Square	CYSM 366629RES	1	0	2-18"	\$2,760	\$3,015	\$4,020
36 x 66x 29" H	Square Bases	CYST 366629RES	1	Sag Bar	2-36"	\$3,240	\$3,495	\$4,500
36 x 66x 36" H	Post Bases	CYP2 366636RES	1	4	Sag Bar	\$2,300	\$2,555	\$3,560
36 x 66x 36" H	Inset Square	CYSM 366636RES	1	0	2-18"	\$2,940	\$3,195	\$4,200
36 x 66x 36" H	Square Bases	CYST 366636RES	1	Sag Bar	2-36"	\$3,360	\$3,615	\$4,620
36 x 66x 42" H	Post Bases	CYP2 366642RES	1	4	Sag Bar	\$2,340	\$2,595	\$3,600
36 x 66x 42" H	Inset Square	CYSM 366642RES	1	0	2-18"	\$3,120	\$3,375	\$4,380
36 x 66x 42" H	Square Bases	CYST 366642RES	1	Sag Bar	2-36"	\$3,480	\$3,735	\$4,740
36 x 72x 29" H	Post Bases	CYP2 367229RES	1	4	Sag Bar	\$2,270	\$2,525	\$3,560
36 x 72x 29" H	Inset Square	CYSM 367229RES	1	0	2-18"	\$2,770	\$3,025	\$4,060
36 x 72x 29" H	Square Bases	CYST 367229RES	1	Sag Bar	2-36"	\$3,250	\$3,505	\$4,540
36 x 72x 36" H	Post Bases	CYP2 367236RES	1	4	Sag Bar	\$2,310	\$2,565	\$3,600
36 x 72x 36" H	Inset Square	CYSM 367236RES	1	0	2-18"	\$2,950	\$3,205	\$4,240
36 x 72x 36" H	Square Bases	CYST 367236RES	1	Sag Bar	2-36"	\$3,370	\$3,625	\$4,660
36 x 72x 42" H	Post Bases	CYP2 367362RES	1	4	Sag Bar	\$2,350	\$2,605	\$3,640
36 x 72x 42" H	Inset Square	CYSM 367362RES	1	0	2-18"	\$3,130	\$3,385	\$4,420
36 x 72x 42" H	Square Bases	CYST 367362RES	1	Sag Bar	2-36"	\$3,490	\$3,745	\$4,780
36 x 84x 29" H	Post Bases	CYP2 368429RES	1	6	0	\$2,950	\$3,250	\$4,310
36 x 84x 29" H	Square/Post Combo	CYSC 368429RES	1	2	2-36"	\$4,050	\$4,350	\$5,410
36 x 84x 29" H	Inset Square	CYSM 368429RES	1	0	2-18"	\$2,920	\$3,220	\$4,280
36 x 84x 29" H	Square Bases	CYST 368429RES	1	0	3-36"	\$3,880	\$4,180	\$5,240
36 x 84x 36" H	Post Bases	CYP2 368436RES	1	6	0	\$3,010	\$3,310	\$4,370
36 x 84x 36" H	Square/Post Combo	CYSC 368436RES	1	2	2-36"	\$4,190	\$4,490	\$5,550
36 x 84x 36" H	Inset Square	CYSM 368436RES	1	0	2-18"	\$3,100	\$3,400	\$4,460
36 x 84x 36" H	Square Bases	CYST 368436RES	1	0	3-36"	\$4,150	\$4,450	\$5,510

POWER & A/V OPTIONS SEE PAGES 8-20

**TABLE OPTIONS:**

Laser cut holes in base - 1.5" x 2.5"

Grommet

WB  
G (B|S)

\$100 list per table

\$20 list per table

# Coby Square – 36" deep

www.hi5furniture.com Questions? 816-774-4050

March 1, 2018

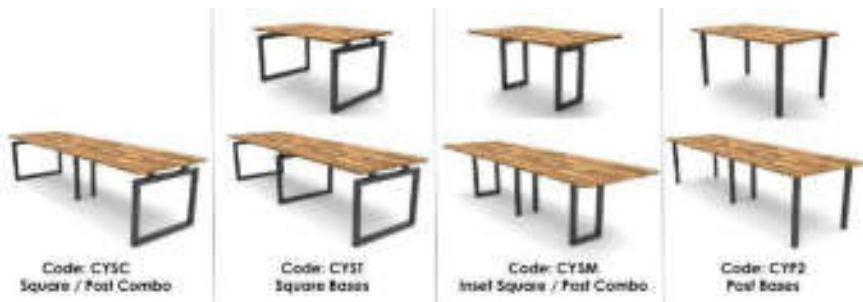

HPL Top Self edges <b>Suffix L6</b>	HPL Top Wood edges <b>Suffix L20</b>	HPL Top Plywood edges <b>Suffix L17</b>	
HPL Top 3mm PVC <b>Suffix L3</b>	HPL Top Knife PVC <b>Suffix L11</b>	HPL Top Knife Wood <b>Suffix L33</b>	HPL Top Knife Plywood <b>Suffix L18</b>

**FINISHES NEEDED:** <http://hi5furniture.com/finishes/>

HPL Top: Hi5 Graded-in laminates or Non-Premium Wilsonart or Formica

Edge Color: Any Hi5 standard

Base Finish: Any Hi5 standard

Table Size	Base Style	Model Code:	# Top Pieces	# of Posts	# of Squares	List Price	List Price	List Price
36 x 84x 42" H	Post Bases	CYP2 368442RES	1	6	0	\$3,070	\$3,370	\$4,430
36 x 84x 42" H	Square/Post Combo	CYSC 368442RES	1	2	2-36"	\$4,330	\$4,630	\$5,690
36 x 84x 42" H	Inset Square	CYSM 368442RES	1	0	2-18"	\$3,280	\$3,580	\$4,640
36 x 84x 42" H	Square Bases	CYST 368442RES	1	0	3-36"	\$4,420	\$4,720	\$5,780
36 x 96x 29" H	Post Bases	CYP2 369629RES	1	6	0	\$2,960	\$3,265	\$4,400
36 x 96x 29" H	Square/Post Combo	CYSC 369629RES	1	2	2-36"	\$4,060	\$4,365	\$5,500
36 x 96x 29" H	Inset Square	CYSM 369629RES	1	0	2-18"	\$2,930	\$3,235	\$4,370
36 x 96x 29" H	Square Bases	CYST 369629RES	1	0	3-36"	\$3,890	\$4,195	\$5,330
36 x 96x 36" H	Post Bases	CYP2 369636RES	1	6	0	\$3,020	\$3,325	\$4,460
36 x 96x 36" H	Square/Post Combo	CYSC 369636RES	1	2	2-36"	\$4,200	\$4,505	\$5,640
36 x 96x 36" H	Inset Square	CYSM 369636RES	1	0	2-18"	\$3,110	\$3,415	\$4,550
36 x 96x 36" H	Square Bases	CYST 369636RES	1	0	3-36"	\$4,160	\$4,465	\$5,600
36 x 96x 42" H	Post Bases	CYP2 369642RES	1	6	0	\$3,080	\$3,385	\$4,520
36 x 96x 42" H	Square/Post Combo	CYSC 369642RES	1	2	2-36"	\$4,340	\$4,645	\$5,780
36 x 96x 42" H	Inset Square	CYSM 369642RES	1	0	2-18"	\$3,290	\$3,595	\$4,730
36 x 96x 42" H	Square Bases	CYST 369642RES	1	0	3-36"	\$4,430	\$4,735	\$5,870
36 x 108x 29" H	Post Bases	CYP2 3610829RES	1	6	0	\$3,120	\$3,705	\$4,620
36 x 108x 29" H	Square/Post Combo	CYSC 3610829RES	1	2	2-36"	\$4,220	\$4,805	\$5,720
36 x 108x 29" H	Inset Combo	CYSM 3610829RES	1	2	2-18"	\$3,740	\$4,325	\$5,240
36 x 108x 29" H	Square Bases	CYST 3610829RES	1	0	3-36"	\$4,770	\$5,355	\$6,270
36 x 108x 36" H	Post Bases	CYP2 3610836RES	1	6	0	\$3,180	\$3,765	\$4,680
36 x 108x 36" H	Square/Post Combo	CYSC 3610836RES	1	2	2-36"	\$4,360	\$4,945	\$5,860
36 x 108x 36" H	Inset Combo	CYSM 3610836RES	1	2	2-18"	\$3,940	\$4,525	\$5,440
36 x 108x 36" H	Square Bases	CYST 3610836RES	1	0	3-36"	\$4,950	\$5,535	\$6,450
36 x 108x 42" H	Post Bases	CYP2 3610842RES	1	6	0	\$3,240	\$3,825	\$4,740
36 x 108x 42" H	Square/Post Combo	CYSC 3610842RES	1	2	2-36"	\$4,500	\$5,085	\$6,000
36 x 108x 42" H	Inset Combo	CYSM 3610842RES	1	2	2-18"	\$4,140	\$4,725	\$5,640
36 x 108x 42" H	Square Bases	CYST 3610842RES	1	0	3-36"	\$5,130	\$5,715	\$6,630

POWER & A/V OPTIONS SEE PAGES 8-20

**TABLE OPTIONS:**

Laser cut holes in base - 1.5" x 2.5"

Grommet

WB  
G (B|S)

\$100 list per table

\$20 list per table

# Coby Square – 36" deep

www.hi5furniture.com Questions? 816-774-4050

March 1, 2018

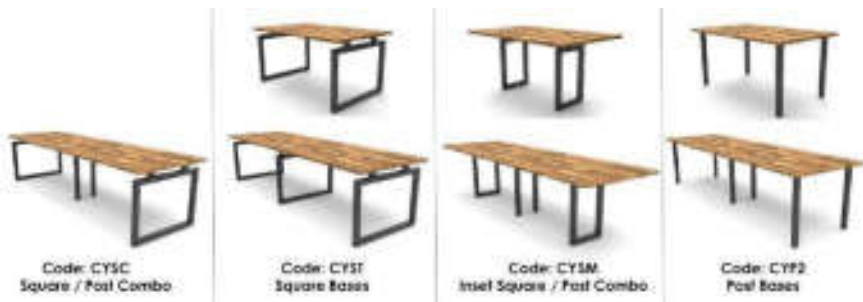

**FINISHES NEEDED:** <http://hi5furniture.com/finishes/>

HPL Top: Hi5 Graded-in laminates or Non-Premium Wilsonart or Formica

Edge Color: Any Hi5 standard

Base Finish: Any Hi5 standard

Table Size	Base Style	Model Code:	# Top Pieces	# of Posts	# of Squares	List Price	List Price	List Price
36 x 120x 29" H	Post Bases	CYP2 3612029RES	1	6	0	\$3,140	\$3,735	\$4,700
36 x 120x 29" H	Square/Post Combo	CYSC 3612029RES	1	2	2-36"	\$4,240	\$4,835	\$5,800
36 x 120x 29" H	Inset Combo	CYSM 3612029RES	1	2	2-18"	\$3,760	\$4,355	\$5,320
36 x 120x 29" H	Square Bases	CYST 3612029RES	1	0	3-36"	\$4,790	\$5,385	\$6,350
36 x 120x 36" H	Post Bases	CYP2 3612036RES	1	6	0	\$3,200	\$3,795	\$4,760
36 x 120x 36" H	Square/Post Combo	CYSC 3612036RES	1	2	2-36"	\$4,380	\$4,975	\$5,940
36 x 120x 36" H	Inset Combo	CYSM 3612036RES	1	2	2-18"	\$3,960	\$4,555	\$5,520
36 x 120x 36" H	Square Bases	CYST 3612036RES	1	0	3-36"	\$4,970	\$5,565	\$6,530
36 x 120x 42" H	Post Bases	CYP2 3612042RES	1	6	0	\$3,260	\$3,855	\$4,820
36 x 120x 42" H	Square/Post Combo	CYSC 3612042RES	1	2	2-36"	\$4,520	\$5,115	\$6,080
36 x 120x 42" H	Inset Combo	CYSM 3612042RES	1	2	2-18"	\$4,160	\$4,755	\$5,720
36 x 120x 42" H	Square Bases	CYST 3612042RES	1	0	3-36"	\$5,150	\$5,745	\$6,710
36 x 132x 29" H	Post Bases	CYP2 3613229RES	2	10	0	\$5,560	\$6,715	\$7,840
36 x 132x 29" H	Square/Post Combo	CYSC 3613229RES	2	6	2-36"	\$6,660	\$7,815	\$8,940
36 x 132x 29" H	Inset Combo	CYSM 3613229RES	2	4	2-18"	\$5,530	\$6,685	\$7,810
36 x 132x 29" H	Square Bases	CYST 3613229RES	2	0	5-36"	\$8,310	\$9,465	\$10,590
36 x 132x 36" H	Post Bases	CYP2 3613236RES	2	10	0	\$5,660	\$6,815	\$7,940
36 x 132x 36" H	Square/Post Combo	CYSC 3613236RES	2	6	2-36"	\$6,840	\$7,995	\$9,120
36 x 132x 36" H	Inset Combo	CYSM 3613236RES	2	4	2-18"	\$5,750	\$6,905	\$8,030
36 x 132x 36" H	Square Bases	CYST 3613236RES	2	0	5-36"	\$8,610	\$9,765	\$10,890
36 x 132x 42" H	Post Bases	CYP2 3613242RES	2	10	0	\$4,750	\$6,090	\$7,510
36 x 132x 42" H	Square/Post Combo	CYSC 3613242RES	2	6	2-36"	\$7,020	\$8,175	\$9,300
36 x 132x 42" H	Inset Combo	CYSM 3613242RES	2	4	2-18"	\$5,970	\$7,125	\$8,250
36 x 132x 42" H	Square Bases	CYST 3613242RES	2	0	5-36"	\$8,910	\$10,065	\$11,190

POWER & A/V OPTIONS SEE PAGES 8-20

**TABLE OPTIONS:**

Laser cut holes in base - 1.5" x 2.5"

Grommet

WB  
G (B|S)

\$100 list per table

\$20 list per table

# Coby Square – 36" deep

www.hi5furniture.com Questions? 816-774-4050

March 1, 2018

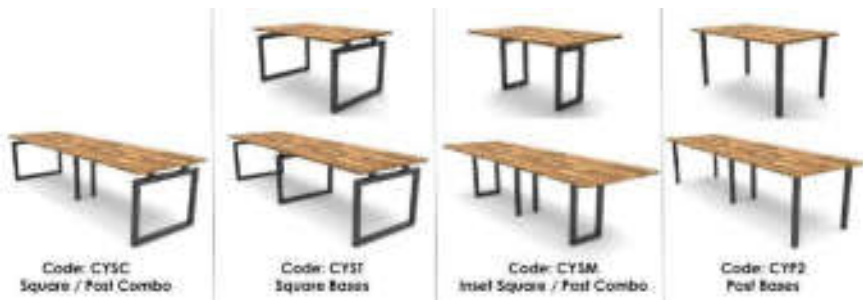

HPL Top Self edges <b>Suffix L6</b>	HPL Top Wood edges <b>Suffix L20</b>	HPL Top Plywood edges <b>Suffix L17</b>	
HPL Top 3mm PVC <b>Suffix L3</b>	HPL Top Knife PVC <b>Suffix L11</b>	HPL Top Knife Wood <b>Suffix L33</b>	HPL Top Knife Plywood <b>Suffix L18</b>

**FINISHES NEEDED:** <http://hi5furniture.com/finishes/>

HPL Top: Hi5 Graded-in laminates or Non-Premium Wilsonart or Formica

Edge Color: Any Hi5 standard

Base Finish: Any Hi5 standard

Table Size	Base Style	Model Code:	# Top Pieces	# of Posts	# of Squares	List Price	List Price	List Price
36 x 144x 29" H	Post Bases	CYP2 3614429RES	2	10	0	\$5,620	\$6,805	\$8,140
36 x 144x 29" H	Square/Post Combo	CYSC 3614429RES	2	6	2-36"	\$6,720	\$7,905	\$9,240
36 x 144x 29" H	Inset Combo	CYSM 3614429RES	2	4	2-18"	\$5,590	\$6,775	\$8,110
36 x 144x 29" H	Square Bases	CYST 3614429RES	2	0	5-36"	\$8,370	\$9,555	\$10,890
36 x 144x 36" H	Post Bases	CYP2 3614436RES	2	10	0	\$5,720	\$6,905	\$8,240
36 x 144x 36" H	Square/Post Combo	CYSC 3614436RES	2	6	2-36"	\$6,900	\$8,085	\$9,420
36 x 144x 36" H	Inset Combo	CYSM 3614436RES	2	4	2-18"	\$5,810	\$6,995	\$8,330
36 x 144x 36" H	Square Bases	CYST 3614436RES	2	0	5-36"	\$8,670	\$9,855	\$11,190
36 x 144x 42" H	Post Bases	CYP2 3614442RES	2	10	0	\$4,440	\$5,625	\$6,960
36 x 144x 42" H	Square/Post Combo	CYSC 3614442RES	2	6	2-36"	\$7,080	\$8,265	\$9,600
36 x 144x 42" H	Inset Combo	CYSM 3614442RES	2	4	2-18"	\$6,030	\$7,215	\$8,550
36 x 144x 42" H	Square Bases	CYST 3614442RES	2	0	5-36"	\$8,970	\$10,155	\$11,490
36 x 168x 29" H	Post Bases	CYP2 3616829RES	2	10	0	\$5,900	\$7,225	\$8,540
36 x 168x 29" H	Square/Post Combo	CYSC 3616829RES	2	6	2-36"	\$7,000	\$8,325	\$9,640
36 x 168x 29" H	Inset Combo	CYSM 3616829RES	2	6	2-18"	\$6,520	\$7,845	\$9,160
36 x 168x 29" H	Square Bases	CYST 3616829RES	2	0	5-36"	\$8,650	\$9,975	\$11,290
36 x 168x 36" H	Post Bases	CYP2 3616836RES	2	10	0	\$6,000	\$7,325	\$8,640
36 x 168x 36" H	Square/Post Combo	CYSC 3616836RES	2	6	2-36"	\$7,180	\$8,505	\$9,820
36 x 168x 36" H	Inset Combo	CYSM 3616836RES	2	6	2-18"	\$6,760	\$8,085	\$9,400
36 x 168x 36" H	Square Bases	CYST 3616836RES	2	0	5-36"	\$8,950	\$10,275	\$11,590
36 x 168x 42" H	Post Bases	CYP2 3616842RES	2	10	0	\$4,720	\$6,045	\$7,360
36 x 168x 42" H	Square/Post Combo	CYSC 3616842RES	2	6	2-36"	\$7,360	\$8,685	\$10,000
36 x 168x 42" H	Inset Combo	CYSM 3616842RES	2	6	2-18"	\$7,000	\$8,325	\$9,640
36 x 168x 42" H	Square Bases	CYST 3616842RES	2	0	5-36"	\$9,250	\$10,575	\$11,890

POWER & A/V OPTIONS SEE PAGES 8-20

**TABLE OPTIONS:**

Laser cut holes in base - 1.5" x 2.5"

Grommet

WB  
G (B|S)

\$100 list per table

\$20 list per table

# Coby Square – 36" deep

www.hi5furniture.com Questions? 816-774-4050

March 1, 2018



**FINISHES NEEDED:** <http://hi5furniture.com/finishes/>

HPL Top: Hi5 Graded-in laminates or Non-Premium Wilsonart or Formica

Edge Color: Any Hi5 standard

Base Finish: Any Hi5 standard

Table Size	Base Style	Model Code:	# Top Pieces	# of Posts	# of Squares	List Price	List Price	List Price
36 x 192x 29" H	Post Bases	CYP2 3619229RES	2	10	0	\$5,930	\$7,270	\$8,690
36 x 192x 29" H	Square/Post Combo	CYSC 3619229RES	2	6	2-36"	\$7,030	\$8,370	\$9,790
36 x 192x 29" H	Inset Combo	CYSM 3619229RES	2	6	2-18"	\$6,550	\$7,890	\$9,310
36 x 192x 29" H	Square Bases	CYST 3619229RES	2	0	5-36"	\$8,680	\$10,020	\$11,440
36 x 192x 36" H	Post Bases	CYP2 3619236RES	2	10	0	\$6,030	\$7,370	\$8,790
36 x 192x 36" H	Square/Post Combo	CYSC 3619236RES	2	6	2-36"	\$7,210	\$8,550	\$9,970
36 x 192x 36" H	Inset Combo	CYSM 3619236RES	2	6	2-18"	\$6,790	\$8,130	\$9,550
36 x 192x 36" H	Square Bases	CYST 3619236RES	2	0	5-36"	\$8,980	\$10,320	\$11,740
36 x 192x 42" H	Post Bases	CYP2 3619242RES	2	10	0	\$4,750	\$6,090	\$7,510
36 x 192x 42" H	Square/Post Combo	CYSC 3619242RES	2	6	2-36"	\$7,390	\$8,730	\$10,150
36 x 192x 42" H	Inset Combo	CYSM 3619242RES	2	6	2-18"	\$7,030	\$8,370	\$9,790
36 x 192x 42" H	Square Bases	CYST 3619242RES	2	0	5-36"	\$9,280	\$10,620	\$12,040
36 x 216x 29" H	Post Bases	CYP2 3621629RES	2	10	0	\$6,210	\$7,690	\$9,080
36 x 216x 29" H	Square/Post Combo	CYSC 3621629RES	2	6	2-36"	\$7,310	\$8,790	\$10,180
36 x 216x 29" H	Inset Combo	CYSM 3621629RES	2	6	2-18"	\$6,830	\$8,310	\$9,700
36 x 216x 29" H	Square Bases	CYST 3621629RES	2	0	5-36"	\$8,960	\$10,440	\$11,830
36 x 216x 36" H	Post Bases	CYP2 3621636RES	2	10	0	\$6,310	\$7,790	\$9,180
36 x 216x 36" H	Square/Post Combo	CYSC 3621636RES	2	6	2-36"	\$7,490	\$8,970	\$10,360
36 x 216x 36" H	Inset Combo	CYSM 3621636RES	2	6	2-18"	\$7,070	\$8,550	\$9,940
36 x 216x 36" H	Square Bases	CYST 3621636RES	2	0	5-36"	\$9,260	\$10,740	\$12,130
36 x 216x 42" H	Post Bases	CYP2 3621642RES	2	10	0	\$5,030	\$6,510	\$7,900
36 x 216x 42" H	Square/Post Combo	CYSC 3621642RES	2	6	2-36"	\$7,670	\$9,150	\$10,540
36 x 216x 42" H	Inset Combo	CYSM 3621642RES	2	6	2-18"	\$7,310	\$8,790	\$10,180
36 x 216x 42" H	Square Bases	CYST 3621642RES	2	0	5-36"	\$9,560	\$11,040	\$12,430

POWER & A/V OPTIONS SEE PAGES 8-20

**TABLE OPTIONS:**

Laser cut holes in base - 1.5" x 2.5"

Grommet

WB  
G (B|S)

\$100 list per table

\$20 list per table

# Coby Square – 36" deep

www.hi5furniture.com Questions? 816-774-4050

March 1, 2018

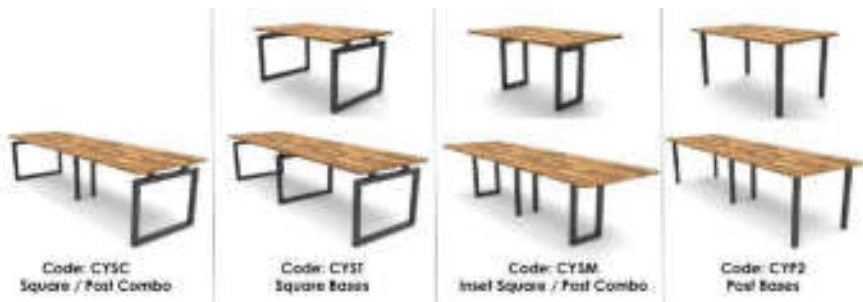

HPL Top Self edges <b>Suffix L6</b>	HPL Top Wood edges <b>Suffix L20</b>	HPL Top Plywood edges <b>Suffix L17</b>	
HPL Top 3mm PVC <b>Suffix L3</b>	HPL Top Knife PVC <b>Suffix L11</b>	HPL Top Knife Wood <b>Suffix L33</b>	HPL Top Knife Plywood <b>Suffix L18</b>

**FINISHES NEEDED:** <http://hi5furniture.com/finishes/>

HPL Top: Hi5 Graded-in laminates or Non-Premium Wilsonart or Formica

Edge Color: Any Hi5 standard

Base Finish: Any Hi5 standard

Table Size	Base Style	Model Code:	# Top Pieces	# of Posts	# of Squares	List Price	List Price	List Price
36 x 240x 29" H	Post Bases	CYP2 3624029RES	2	10	0	\$6,240	\$7,735	\$9,230
36 x 240x 29" H	Square/Post Combo	CYSC 3624029RES	2	6	2-36"	\$7,340	\$8,835	\$10,330
36 x 240x 29" H	Inset Combo	CYSM 3624029RES	2	6	2-18"	\$6,860	\$8,355	\$9,850
36 x 240x 29" H	Square Bases	CYST 3624029RES	2	0	5-36"	\$8,990	\$10,485	\$11,980
36 x 240x 36" H	Post Bases	CYP2 3624036RES	2	10	0	\$6,340	\$7,835	\$9,330
36 x 240x 36" H	Square/Post Combo	CYSC 3624036RES	2	6	2-36"	\$7,520	\$9,015	\$10,510
36 x 240x 36" H	Inset Combo	CYSM 3624036RES	2	6	2-18"	\$7,100	\$8,595	\$10,090
36 x 240x 36" H	Square Bases	CYST 3624036RES	2	0	5-36"	\$9,290	\$10,785	\$12,280
36 x 240x 42" H	Post Bases	CYP2 3624042RES	2	10	0	\$5,060	\$6,555	\$8,050
36 x 240x 42" H	Square/Post Combo	CYSC 3624042RES	2	6	2-36"	\$7,700	\$9,195	\$10,690
36 x 240x 42" H	Inset Combo	CYSM 3624042RES	2	6	2-18"	\$7,340	\$8,835	\$10,330
36 x 240x 42" H	Square Bases	CYST 3624042RES	2	0	5-36"	\$9,590	\$11,085	\$12,580

POWER & A/V OPTIONS SEE PAGES 8-20

**TABLE OPTIONS:**

Laser cut holes in base - 1.5" x 2.5"

Grommet

WB  
G (B|S)

\$100 list per table

\$20 list per table

# Coby Square – 42" deep

www.hi5furniture.com Questions? 816-774-4050

March 1, 2018

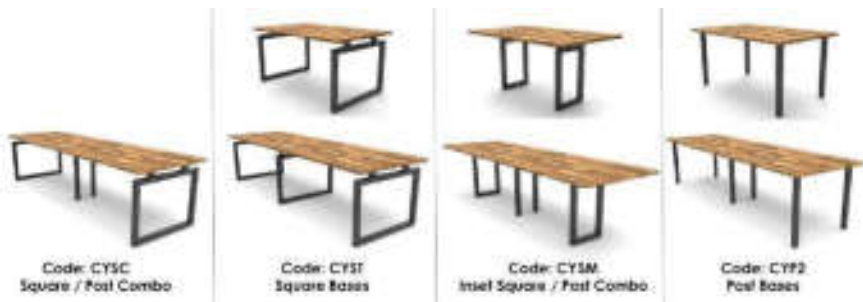

**FINISHES NEEDED:** <http://hi5furniture.com/finishes/>

HPL Top: Hi5 Graded-in laminates or Non-Premium Wilsonart or Formica

Edge Color: Any Hi5 standard

Base Finish: Any Hi5 standard

Table Size	Base Style	Model Code:	# Top Pieces	# of Posts	# of Squares	List Price	List Price	List Price
42 x 60x 29" H	Post Bases	CYP2 426029RES	1	6	0	\$2,840	\$3,110	\$4,100
42 x 60x 29" H	Square/Post Combo	CYSC 426029 RES	1	2	2-42"	\$4,060	\$4,330	\$5,320
42 x 60x 29" H	Inset Square	CYSM 426029 RES	1	0	2-24"	\$2,930	\$3,200	\$4,190
42 x 60x 29" H	Square Bases	CYST 426029RES	1	0	3-42"	\$4,670	\$4,940	\$5,930
42 x 60x 36" H	Post Bases	CYP2 426036RES	1	6	0	\$2,900	\$3,170	\$4,160
42 x 60x 36" H	Square/Post Combo	CYSC 426036 RES	1	2	2-42"	\$4,200	\$4,470	\$5,460
42 x 60x 36" H	Inset Square	CYSM 426036 RES	1	0	2-24"	\$3,110	\$3,380	\$4,370
42 x 60x 36" H	Square Bases	CYST 426036RES	1	0	3-42"	\$4,850	\$5,120	\$6,110
42 x 60x 42" H	Post Bases	CYP2 426042RES	1	6	0	\$2,960	\$3,230	\$4,220
42 x 60x 42" H	Square/Post Combo	CYSC 426042 RES	1	2	2-42"	\$4,340	\$4,610	\$5,600
42 x 60x 42" H	Inset Square	CYSM 426042 RES	1	0	2-24"	\$3,290	\$3,560	\$4,550
42 x 60x 42" H	Square Bases	CYST 426042RES	1	0	3-42"	\$5,030	\$5,300	\$6,290
42 x 66x 29" H	Post Bases	CYP2 426629RES	1	6	0	\$2,940	\$3,240	\$4,230
42 x 66x 29" H	Square/Post Combo	CYSC 426629 RES	1	2	2-42"	\$4,160	\$4,460	\$5,450
42 x 66x 29" H	Inset Square	CYSM 426629 RES	1	0	2-24"	\$3,030	\$3,330	\$4,320
42 x 66x 29" H	Square Bases	CYST 426629RES	1	0	3-42"	\$4,770	\$5,070	\$6,060
42 x 66x 36" H	Post Bases	CYP2 426636RES	1	6	0	\$3,000	\$3,300	\$4,290
42 x 66x 36" H	Square/Post Combo	CYSC 426636 RES	1	2	2-42"	\$4,300	\$4,600	\$5,590
42 x 66x 36" H	Inset Square	CYSM 426636 RES	1	0	2-24"	\$3,210	\$3,510	\$4,500
42 x 66x 36" H	Square Bases	CYST 426636RES	1	0	3-42"	\$4,950	\$5,250	\$6,240
42 x 66x 42" H	Post Bases	CYP2 426642RES	1	6	0	\$3,060	\$3,360	\$4,350
42 x 66x 42" H	Square/Post Combo	CYSC 426642 RES	1	2	2-42"	\$4,440	\$4,740	\$5,730
42 x 66x 42" H	Inset Square	CYSM 426642 RES	1	0	2-24"	\$3,390	\$3,690	\$4,680
42 x 66x 42" H	Square Bases	CYST 426642RES	1	0	3-42"	\$5,130	\$5,430	\$6,420

POWER & A/V OPTIONS SEE PAGES 8-20

**TABLE OPTIONS:**

Laser cut holes in base - 1.5" x 2.5"

Grommet

WB  
G (B|S)

\$100 list per table

\$20 list per table



# Coby Square – 42" deep

www.hi5furniture.com Questions? 816-774-4050

March 1, 2018

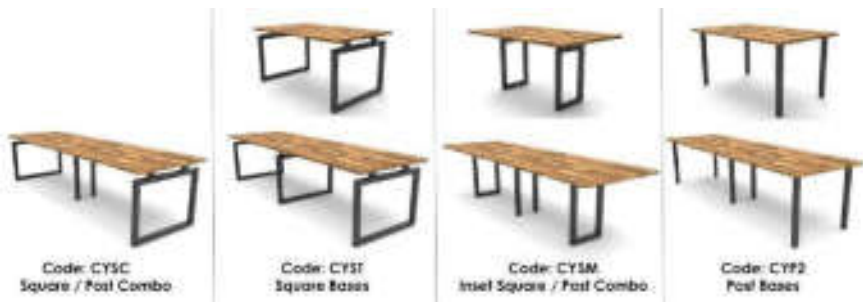

HPL Top Self edges <b>Suffix L6</b>	HPL Top Wood edges <b>Suffix L20</b>	HPL Top Plywood edges <b>Suffix L17</b>	
HPL Top 3mm PVC <b>Suffix L3</b>	HPL Top Knife PVC <b>Suffix L11</b>	HPL Top Knife Wood <b>Suffix L33</b>	HPL Top Knife Plywood <b>Suffix L18</b>

**FINISHES NEEDED:** <http://hi5furniture.com/finishes/>

HPL Top: Hi5 Graded-in laminates or Non-Premium Wilsonart or Formica

Edge Color: Any Hi5 standard

Base Finish: Any Hi5 standard

Table Size	Base Style	Model Code:	# Top Pieces	# of Posts	# of Squares	List Price	List Price	List Price
42 x 72x 29" H	Post Bases	CYP2 427229RES	1	6	0	\$2,940	\$3,240	\$4,270
42 x 72x 29" H	Square/Post Combo	CYSC 427229 RES	1	2	2-42"	\$4,160	\$4,460	\$5,490
42 x 72x 29" H	Inset Square	CYSM 427229 RES	1	0	2-24"	\$3,030	\$3,330	\$4,360
42 x 72x 29" H	Square Bases	CYST 427229RES	1	0	3-42"	\$4,770	\$5,070	\$6,100
42 x 72x 36" H	Post Bases	CYP2 427236RES	1	6	0	\$3,000	\$3,300	\$4,330
42 x 72x 36" H	Square/Post Combo	CYSC 427236 RES	1	2	2-42"	\$4,300	\$4,600	\$5,630
42 x 72x 36" H	Inset Square	CYSM 427236 RES	1	0	2-24"	\$3,210	\$3,510	\$4,540
42 x 72x 36" H	Square Bases	CYST 427236RES	1	0	3-42"	\$4,950	\$5,250	\$6,280
42 x 72x 42" H	Post Bases	CYP2 427242RES	1	6	0	\$3,060	\$3,360	\$4,390
42 x 72x 42" H	Square/Post Combo	CYSC 427242 RES	1	2	2-42"	\$4,440	\$4,740	\$5,770
42 x 72x 42" H	Inset Square	CYSM 427242 RES	1	0	2-24"	\$3,390	\$3,690	\$4,720
42 x 72x 42" H	Square Bases	CYST 427242RES	1	0	3-42"	\$5,130	\$5,430	\$6,460
42 x 84x 29" H	Post Bases	CYP2 428429RES	1	6	0	\$3,140	\$3,500	\$4,540
42 x 84x 29" H	Square/Post Combo	CYSC 428429 RES	1	2	2-42"	\$4,360	\$4,720	\$5,760
42 x 84x 29" H	Inset Square	CYSM 428429 RES	1	0	2-24"	\$3,230	\$3,590	\$4,630
42 x 84x 29" H	Square Bases	CYST 428429RES	1	0	3-42"	\$4,970	\$5,330	\$6,370
42 x 84x 36" H	Post Bases	CYP2 428436RES	1	6	0	\$3,200	\$3,560	\$4,600
42 x 84x 36" H	Square/Post Combo	CYSC 428436 RES	1	2	2-42"	\$4,500	\$4,860	\$5,900
42 x 84x 36" H	Inset Square	CYSM 428436 RES	1	0	2-24"	\$3,410	\$3,770	\$4,810
42 x 84x 36" H	Square Bases	CYST 428436RES	1	0	3-42"	\$5,150	\$5,510	\$6,550
42 x 84x 42" H	Post Bases	CYP2 428442RES	1	6	0	\$3,260	\$3,620	\$4,660
42 x 84x 42" H	Square/Post Combo	CYSC 428442 RES	1	2	2-42"	\$4,640	\$5,000	\$6,040
42 x 84x 42" H	Inset Square	CYSM 428442 RES	1	0	2-24"	\$3,590	\$3,950	\$4,990
42 x 84x 42" H	Square Bases	CYST 428442RES	1	0	3-42"	\$5,330	\$5,690	\$6,730

POWER & A/V OPTIONS SEE PAGES 8-20

**TABLE OPTIONS:**

Laser cut holes in base - 1.5" x 2.5"

Grommet

WB  
G (B | S)

\$100 list per table

\$20 list per table

# Coby Square – 42" deep

www.hi5furniture.com Questions? 816-774-4050

March 1, 2018

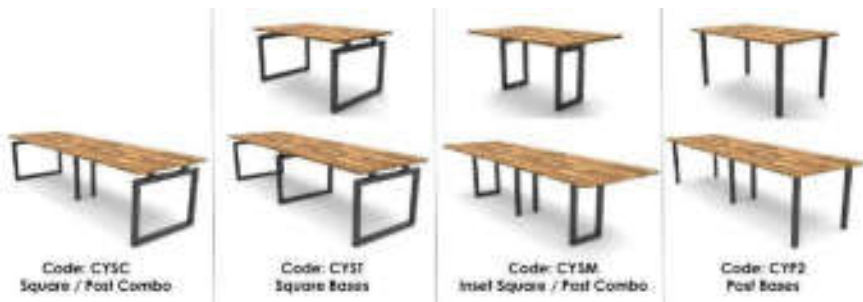

HPL Top Self edges <b>Suffix L6</b>	HPL Top Wood edges <b>Suffix L20</b>	HPL Top Plywood edges <b>Suffix L17</b>	
HPL Top 3mm PVC <b>Suffix L3</b>	HPL Top Knife PVC <b>Suffix L11</b>	HPL Top Knife Wood <b>Suffix L33</b>	HPL Top Knife Plywood <b>Suffix L18</b>

**FINISHES NEEDED:** <http://hi5furniture.com/finishes/>

HPL Top: Hi5 Graded-in laminates or Non-Premium Wilsonart or Formica

Edge Color: Any Hi5 standard

Base Finish: Any Hi5 standard

Table Size	Base Style	Model Code:	# Top Pieces	# of Posts	# of Squares	List Price	List Price	List Price
42 x 96x 29" H	Post Bases	CYP2 429629RES	1	6	0	\$3,160	\$3,525	\$4,620
42 x 96x 29" H	Square/Post Combo	CYSC 429629RES	1	2	2-42"	\$4,380	\$4,745	\$5,840
42 x 96x 29" H	Inset Square	CYSM 429629RES	1	0	2-24"	\$3,250	\$3,615	\$4,710
42 x 96x 29" H	Square Bases	CYST 429629RES	1	0	3-42"	\$4,990	\$5,355	\$6,450
42 x 96x 36" H	Post Bases	CYP2 429636RES	1	6	0	\$3,220	\$3,585	\$4,680
42 x 96x 36" H	Square/Post Combo	CYSC 429636RES	1	2	2-42"	\$4,520	\$4,885	\$5,980
42 x 96x 36" H	Inset Square	CYSM 429636RES	1	0	2-24"	\$3,430	\$3,795	\$4,890
42 x 96x 36" H	Square Bases	CYST 429636RES	1	0	3-42"	\$5,170	\$5,535	\$6,630
42 x 96x 42" H	Post Bases	CYP2 429642RES	1	6	0	\$3,280	\$3,645	\$4,740
42 x 96x 42" H	Square/Post Combo	CYSC 429642RES	1	2	2-42"	\$4,660	\$5,025	\$6,120
42 x 96x 42" H	Inset Square	CYSM 429642RES	1	0	2-24"	\$3,610	\$3,975	\$5,070
42 x 96x 42" H	Square Bases	CYST 429642RES	1	0	3-42"	\$5,350	\$5,715	\$6,810
42 x 108x 29" H	Post Bases	CYP2 4210829RES	1	6	0	\$3,360	\$4,065	\$4,890
42 x 108x 29" H	Square/Post Combo	CYSC 4210829RES	1	2	2-42"	\$4,580	\$5,285	\$6,110
42 x 108x 29" H	Inset Combo	CYSM 4210829RES	1	2	2-24"	\$4,100	\$4,805	\$5,630
42 x 108x 29" H	Square Bases	CYST 4210829RES	1	0	3-42"	\$5,190	\$5,895	\$6,720
42 x 108x 36" H	Post Bases	CYP2 4210836RES	1	6	0	\$3,420	\$4,125	\$4,950
42 x 108x 36" H	Square/Post Combo	CYSC 4210836RES	1	2	2-42"	\$4,720	\$5,425	\$6,250
42 x 108x 36" H	Inset Combo	CYSM 4210836RES	1	2	2-24"	\$4,300	\$5,005	\$5,830
42 x 108x 36" H	Square Bases	CYST 4210836RES	1	0	3-42"	\$5,370	\$6,075	\$6,900
42 x 108x 42" H	Post Bases	CYP2 4210842RES	1	6	0	\$3,480	\$4,185	\$5,010
42 x 108x 42" H	Square/Post Combo	CYSC 4210842RES	1	2	2-42"	\$4,860	\$5,565	\$6,390
42 x 108x 42" H	Inset Combo	CYSM 4210842RES	1	2	2-24"	\$4,500	\$5,205	\$6,030
42 x 108x 42" H	Square Bases	CYST 4210842RES	1	0	3-42"	\$5,550	\$6,255	\$7,080

POWER & A/V OPTIONS SEE PAGES 8-20

**TABLE OPTIONS:**

Laser cut holes in base - 1.5" x 2.5"

Grommet

WB  
G (B|S)

\$100 list per table

\$20 list per table

# Coby Square – 42" deep

www.hi5furniture.com Questions? 816-774-4050

March 1, 2018

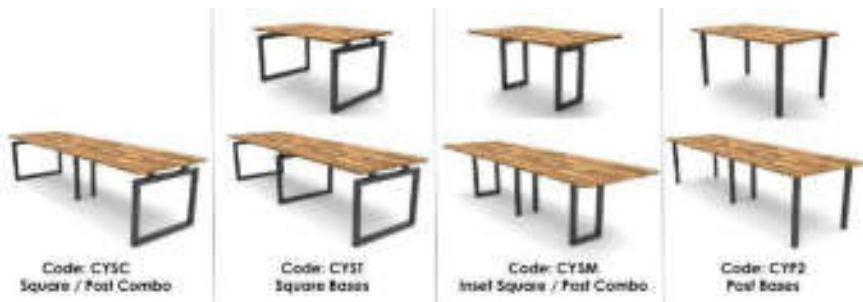

**FINISHES NEEDED:** <http://hi5furniture.com/finishes/>

HPL Top: Hi5 Graded-in laminates or Non-Premium Wilsonart or Formica

Edge Color: Any Hi5 standard

Base Finish: Any Hi5 standard

Table Size	Base Style	Model Code:	# Top Pieces	# of Posts	# of Squares	List Price	List Price	List Price
42 x 120x 29" H	Post Bases	CYP2 4212029RES	1	6	0	\$3,380	\$4,095	\$4,980
42 x 120x 29" H	Square/Post Combo	CYSC 4212029RES	1	2	2-42"	\$4,600	\$5,315	\$6,200
42 x 120x 29" H	Inset Combo	CYSM 4212029RES	1	2	2-24"	\$4,120	\$4,835	\$5,720
42 x 120x 29" H	Square Bases	CYST 4212029RES	1	0	3-42"	\$5,210	\$5,925	\$6,810
42 x 120x 36" H	Post Bases	CYP2 4212036RES	1	6	0	\$3,440	\$4,155	\$5,040
42 x 120x 36" H	Square/Post Combo	CYSC 4212036RES	1	2	2-42"	\$4,740	\$5,455	\$6,340
42 x 120x 36" H	Inset Combo	CYSM 4212036RES	1	2	2-24"	\$4,320	\$5,035	\$5,920
42 x 120x 36" H	Square Bases	CYST 4212036RES	1	0	3-42"	\$5,390	\$6,105	\$6,990
42 x 120x 42" H	Post Bases	CYP2 4212042RES	1	6	0	\$3,500	\$4,215	\$5,100
42 x 120x 42" H	Square/Post Combo	CYSC 4212042RES	1	2	2-42"	\$4,880	\$5,595	\$6,480
42 x 120x 42" H	Inset Combo	CYSM 4212042RES	1	2	2-24"	\$4,520	\$5,235	\$6,120
42 x 120x 42" H	Square Bases	CYST 4212042RES	1	0	3-42"	\$5,570	\$6,285	\$7,170
42 x 132x 29" H	Post Bases	CYP2 4213229RES	2	10	0	\$5,820	\$7,105	\$8,120
42 x 132x 29" H	Square/Post Combo	CYSC 4213229RES	2	6	2-42"	\$7,040	\$8,325	\$9,340
42 x 132x 29" H	Inset Combo	CYSM 4213229RES	2	4	2-24"	\$5,910	\$7,195	\$8,210
42 x 132x 29" H	Square Bases	CYST 4213229RES	2	0	5-42"	\$8,870	\$10,155	\$11,170
42 x 132x 36" H	Post Bases	CYP2 4213236RES	2	10	0	\$5,920	\$7,205	\$8,220
42 x 132x 36" H	Square/Post Combo	CYSC 4213236RES	2	6	2-42"	\$7,220	\$8,505	\$9,520
42 x 132x 36" H	Inset Combo	CYSM 4213236RES	2	4	2-24"	\$6,130	\$7,415	\$8,430
42 x 132x 36" H	Square Bases	CYST 4213236RES	2	0	5-42"	\$9,170	\$10,455	\$11,470
42 x 132x 42" H	Post Bases	CYP2 4213242RES	2	10	0	\$6,020	\$7,305	\$8,320
42 x 132x 42" H	Square/Post Combo	CYSC 4213242RES	2	6	2-42"	\$7,400	\$8,685	\$9,700
42 x 132x 42" H	Inset Combo	CYSM 4213242RES	2	4	2-24"	\$6,350	\$7,635	\$8,650
42 x 132x 42" H	Square Bases	CYST 4213242RES	2	0	5-42"	\$9,470	\$10,755	\$11,770

POWER & A/V OPTIONS SEE PAGES 8-20

**TABLE OPTIONS:**

Laser cut holes in base - 1.5" x 2.5"

Grommet

WB  
G (B|S)

\$100 list per table

\$20 list per table

# Coby Square – 42" deep

www.hi5furniture.com Questions? 816-774-4050

March 1, 2018

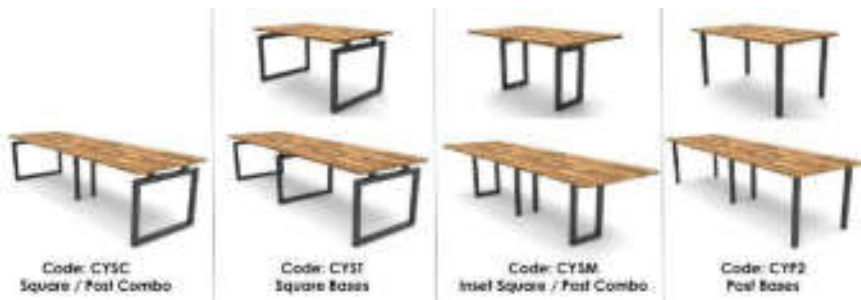

**FINISHES NEEDED:** <http://hi5furniture.com/finishes/>

HPL Top: Hi5 Graded-in laminates or Non-Premium Wilsonart or Formica

Edge Color: Any Hi5 standard

Base Finish: Any Hi5 standard

Table Size	Base Style	Model Code:	# Top Pieces	# of Posts	# of Squares	List Price	List Price	List Price
42 x 144x 29" H	Post Bases	CYP2 4214429RES	2	10	0	\$5,890	\$7,210	\$8,460
42 x 144x 29" H	Square/Post Combo	CYSC 4214429RES	2	6	2-42"	\$7,110	\$8,430	\$9,680
42 x 144x 29" H	Inset Combo	CYSM 4214429RES	2	4	2-24"	\$5,980	\$7,300	\$8,550
42 x 144x 29" H	Square Bases	CYST 4214429RES	2	0	5-42"	\$8,940	\$10,260	\$11,510
42 x 144x 36" H	Post Bases	CYP2 4214436RES	2	10	0	\$5,990	\$7,310	\$8,560
42 x 144x 36" H	Square/Post Combo	CYSC 4214436RES	2	6	2-42"	\$7,290	\$8,610	\$9,860
42 x 144x 36" H	Inset Combo	CYSM 4214436RES	2	4	2-24"	\$6,200	\$7,520	\$8,770
42 x 144x 36" H	Square Bases	CYST 4214436RES	2	0	5-42"	\$9,240	\$10,560	\$11,810
42 x 144x 42" H	Post Bases	CYP2 4214442RES	2	10	0	\$6,090	\$7,410	\$8,660
42 x 144x 42" H	Square/Post Combo	CYSC 4214442RES	2	6	2-42"	\$7,470	\$8,790	\$10,040
42 x 144x 42" H	Inset Combo	CYSM 4214442RES	2	4	2-24"	\$6,420	\$7,740	\$8,990
42 x 144x 42" H	Square Bases	CYST 4214442RES	2	0	5-42"	\$9,540	\$10,860	\$12,110
42 x 168x 29" H	Post Bases	CYP2 4216829RES	2	10	0	\$6,250	\$7,750	\$8,940
42 x 168x 29" H	Square/Post Combo	CYSC 4216829RES	2	6	2-42"	\$7,470	\$8,970	\$10,160
42 x 168x 29" H	Inset Combo	CYSM 4216829RES	2	6	2-24"	\$6,990	\$8,490	\$9,680
42 x 168x 29" H	Square Bases	CYST 4216829RES	2	0	5-42"	\$9,300	\$10,800	\$11,990
42 x 168x 36" H	Post Bases	CYP2 4216836RES	2	10	0	\$6,350	\$7,850	\$9,040
42 x 168x 36" H	Square/Post Combo	CYSC 4216836RES	2	6	2-42"	\$7,650	\$9,150	\$10,340
42 x 168x 36" H	Inset Combo	CYSM 4216836RES	2	6	2-24"	\$7,230	\$8,730	\$9,920
42 x 168x 36" H	Square Bases	CYST 4216836RES	2	0	5-42"	\$9,600	\$11,100	\$12,290
42 x 168x 42" H	Post Bases	CYP2 4216842RES	2	10	0	\$6,450	\$7,950	\$9,140
42 x 168x 42" H	Square/Post Combo	CYSC 4216842RES	2	6	2-42"	\$7,830	\$9,330	\$10,520
42 x 168x 42" H	Inset Combo	CYSM 4216842RES	2	6	2-24"	\$7,470	\$8,970	\$10,160
42 x 168x 42" H	Square Bases	CYST 4216842RES	2	0	5-42"	\$9,900	\$11,400	\$12,590

POWER & A/V OPTIONS SEE PAGES 8-20

**TABLE OPTIONS:**

Laser cut holes in base - 1.5" x 2.5"

Grommet

WB  
G (B | S)

\$100 list per table

\$20 list per table

# Coby Square – 42" deep

www.hi5furniture.com Questions? 816-774-4050

March 1, 2018

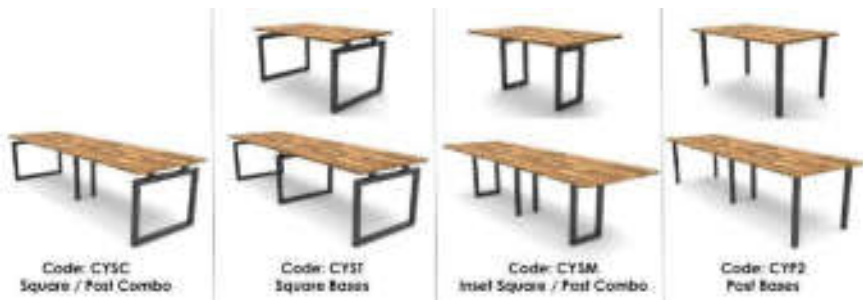

**FINISHES NEEDED:** <http://hi5furniture.com/finishes/>

HPL Top: Hi5 Graded-in laminates or Non-Premium Wilsonart or Formica

Edge Color: Any Hi5 standard

Base Finish: Any Hi5 standard

Table Size	Base Style	Model Code:	# Top Pieces	# of Posts	# of Squares	List Price	List Price	List Price
42 x 192x 29" H	Post Bases	CYP2 4219229RES	2	10	0	\$6,280	\$7,795	\$9,090
42 x 192x 29" H	Square/Post Combo	CYSC 4219229RES	2	6	2-42"	\$7,500	\$9,015	\$10,310
42 x 192x 29" H	Inset Combo	CYSM 4219229RES	2	6	2-24"	\$7,020	\$8,535	\$9,830
42 x 192x 29" H	Square Bases	CYST 4219229RES	2	0	5-42"	\$9,330	\$10,845	\$12,140
42 x 192x 36" H	Post Bases	CYP2 4219236RES	2	10	0	\$6,380	\$7,895	\$9,190
42 x 192x 36" H	Square/Post Combo	CYSC 4219236RES	2	6	2-42"	\$7,680	\$9,195	\$10,490
42 x 192x 36" H	Inset Combo	CYSM 4219236RES	2	6	2-24"	\$7,260	\$8,775	\$10,070
42 x 192x 36" H	Square Bases	CYST 4219236RES	2	0	5-42"	\$9,630	\$11,145	\$12,440
42 x 192x 42" H	Post Bases	CYP2 4219242RES	2	10	0	\$6,480	\$7,995	\$9,290
42 x 192x 42" H	Square/Post Combo	CYSC 4219242RES	2	6	2-42"	\$7,860	\$9,375	\$10,670
42 x 192x 42" H	Inset Combo	CYSM 4219242RES	2	6	2-24"	\$7,500	\$9,015	\$10,310
42 x 192x 42" H	Square Bases	CYST 4219242RES	2	0	5-42"	\$9,930	\$11,445	\$12,740
42 x 216x 29" H	Post Bases	CYP2 4221629RES	2	10	0	\$6,640	\$8,335	\$9,560
42 x 216x 29" H	Square/Post Combo	CYSC 4221629RES	2	6	2-42"	\$7,860	\$9,555	\$10,780
42 x 216x 29" H	Inset Combo	CYSM 4221629RES	2	6	2-24"	\$7,380	\$9,075	\$10,300
42 x 216x 29" H	Square Bases	CYST 4221629RES	2	0	5-42"	\$9,690	\$11,385	\$12,610
42 x 216x 36" H	Post Bases	CYP2 4221636RES	2	10	0	\$6,740	\$8,435	\$9,660
42 x 216x 36" H	Square/Post Combo	CYSC 4221636RES	2	6	2-42"	\$8,040	\$9,735	\$10,960
42 x 216x 36" H	Inset Combo	CYSM 4221636RES	2	6	2-24"	\$7,620	\$9,315	\$10,540
42 x 216x 36" H	Square Bases	CYST 4221636RES	2	0	5-42"	\$9,990	\$11,685	\$12,910
42 x 216x 42" H	Post Bases	CYP2 4221642RES	2	10	0	\$6,840	\$8,535	\$9,760
42 x 216x 42" H	Square/Post Combo	CYSC 4221642RES	2	6	2-42"	\$8,220	\$9,915	\$11,140
42 x 216x 42" H	Inset Combo	CYSM 4221642RES	2	6	2-24"	\$7,860	\$9,555	\$10,780
42 x 216x 42" H	Square Bases	CYST 4221642RES	2	0	5-42"	\$10,290	\$11,985	\$13,210

POWER & A/V OPTIONS SEE PAGES 8-20

**TABLE OPTIONS:**

Laser cut holes in base - 1.5" x 2.5"

Grommet

WB  
G (B|S)

\$100 list per table

\$20 list per table

# Coby Square – 42" deep

www.hi5furniture.com Questions? 816-774-4050

March 1, 2018

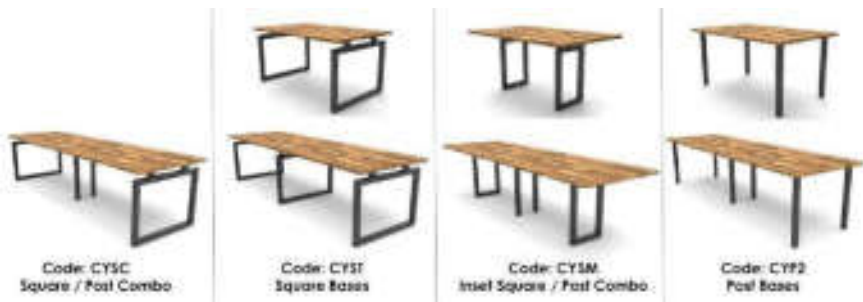

**FINISHES NEEDED:** <http://hi5furniture.com/finishes/>

HPL Top: Hi5 Graded-in laminates or Non-Premium Wilsonart or Formica

Edge Color: Any Hi5 standard

Base Finish: Any Hi5 standard

Table Size	Base Style	Model Code:	# Top Pieces	# of Posts	# of Squares	List Price	List Price	List Price
42 x 240x 29" H	Post Bases	CYP2 4224029RES	2	10	0	\$6,670	\$8,380	\$9,710
42 x 240x 29" H	Square/Post Combo	CYSC 4224029RES	2	6	2-42"	\$7,890	\$9,600	\$10,930
42 x 240x 29" H	Inset Combo	CYSM 4224029RES	2	6	2-24"	\$7,410	\$9,120	\$10,450
42 x 240x 29" H	Square Bases	CYST 4224029RES	2	0	5-42"	\$9,720	\$11,430	\$12,760
42 x 240x 36" H	Post Bases	CYP2 4224036RES	2	10	0	\$6,770	\$8,480	\$9,810
42 x 240x 36" H	Square/Post Combo	CYSC 4224036RES	2	6	2-42"	\$8,070	\$9,780	\$11,110
42 x 240x 36" H	Inset Combo	CYSM 4224036RES	2	6	2-24"	\$7,650	\$9,360	\$10,690
42 x 240x 36" H	Square Bases	CYST 4224036RES	2	0	5-42"	\$10,020	\$11,730	\$13,060
42 x 240x 42" H	Post Bases	CYP2 4224042RES	2	10	0	\$6,870	\$8,580	\$9,910
42 x 240x 42" H	Square/Post Combo	CYSC 4224042RES	2	6	2-42"	\$8,250	\$9,960	\$11,290
42 x 240x 42" H	Inset Combo	CYSM 4224042RES	2	6	2-24"	\$7,890	\$9,600	\$10,930
42 x 240x 42" H	Square Bases	CYST 4224042RES	2	0	5-42"	\$10,320	\$12,030	\$13,360

POWER & A/V OPTIONS SEE PAGES 8-20

**TABLE OPTIONS:**

Laser cut holes in base - 1.5" x 2.5"

Grommet

WB  
G (B|S)

\$100 list per table

\$20 list per table

# Coby Square – 48" deep

www.hi5furniture.com Questions? 816-774-4050

March 1, 2018

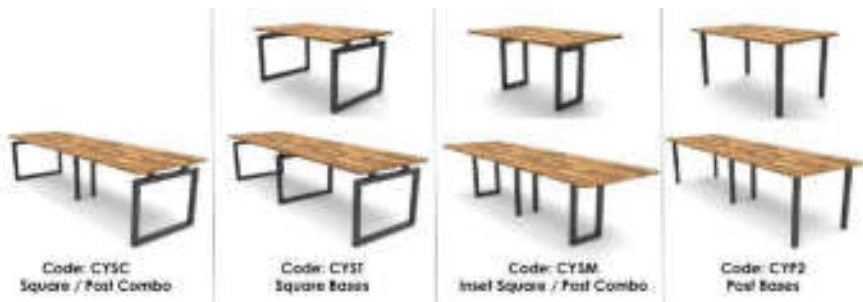

**FINISHES NEEDED:** <http://hi5furniture.com/finishes/>

HPL Top: Hi5 Graded-in laminates or Non-Premium Wilsonart or Formica

Edge Color: Any Hi5 standard

Base Finish: Any Hi5 standard

Table Size	Base Style	Model Code:	# Top Pieces	# of Posts	# of Squares	List Price	List Price	List Price
48 x 60x 29" H	Post Bases	CYP2 486029RES	1	6	0	\$2,840	\$3,110	\$4,140
48 x 60x 29" H	Square/Post Combo	CYSC 486029 RES	1	2	2-48"	\$4,180	\$4,450	\$5,480
48 x 60x 29" H	Inset Square	CYSM 486029 RES	1	0	2-24"	\$2,930	\$3,200	\$4,230
48 x 60x 29" H	Square Bases	CYST 486029RES	1	0	3-48"	\$4,850	\$5,120	\$6,150
48 x 60x 36" H	Post Bases	CYP2 486036RES	1	6	0	\$2,900	\$3,170	\$4,200
48 x 60x 36" H	Square/Post Combo	CYSC 486036 RES	1	2	2-48"	\$4,320	\$4,590	\$5,620
48 x 60x 36" H	Inset Square	CYSM 486036 RES	1	0	2-24"	\$3,110	\$3,380	\$4,410
48 x 60x 36" H	Square Bases	CYST 486036RES	1	0	3-48"	\$5,030	\$5,300	\$6,330
48 x 60x 42" H	Post Bases	CYP2 486042RES	1	6	0	\$2,960	\$3,230	\$4,260
48 x 60x 42" H	Square/Post Combo	CYSC 486042 RES	1	2	2-48"	\$4,460	\$4,730	\$5,760
48 x 60x 42" H	Inset Square	CYSM 486042 RES	1	0	2-24"	\$3,290	\$3,560	\$4,590
48 x 60x 42" H	Square Bases	CYST 486042RES	1	0	3-48"	\$5,210	\$5,480	\$6,510
48 x 66x 29" H	Post Bases	CYP2 486629RES	1	6	0	\$2,940	\$3,240	\$4,270
48 x 66x 29" H	Square/Post Combo	CYSC 486629 RES	1	2	2-48"	\$4,280	\$4,580	\$5,610
48 x 66x 29" H	Inset Square	CYSM 486629 RES	1	0	2-24"	\$3,030	\$3,330	\$4,360
48 x 66x 29" H	Square Bases	CYST 486629RES	1	0	3-48"	\$4,950	\$5,250	\$6,280
48 x 66x 36" H	Post Bases	CYP2 486636RES	1	6	0	\$3,000	\$3,300	\$4,330
48 x 66x 36" H	Square/Post Combo	CYSC 486636 RES	1	2	2-48"	\$4,420	\$4,720	\$5,750
48 x 66x 36" H	Inset Square	CYSM 486636 RES	1	0	2-24"	\$3,210	\$3,510	\$4,540
48 x 66x 36" H	Square Bases	CYST 486636RES	1	0	3-48"	\$5,130	\$5,430	\$6,460
48 x 66x 42" H	Post Bases	CYP2 486642RES	1	6	0	\$3,060	\$3,360	\$4,390
48 x 66x 42" H	Square/Post Combo	CYSC 486642 RES	1	2	2-48"	\$4,560	\$4,860	\$5,890
48 x 66x 42" H	Inset Square	CYSM 486642 RES	1	0	2-24"	\$3,390	\$3,690	\$4,720
48 x 66x 42" H	Square Bases	CYST 486642RES	1	0	3-48"	\$5,310	\$5,610	\$6,640

POWER & A/V OPTIONS SEE PAGES 8-20

**TABLE OPTIONS:**

Laser cut holes in base - 1.5" x 2.5"

Grommet

WB  
G (B|S)

\$100 list per table

\$20 list per table

# Coby Square – 48" deep

www.hi5furniture.com Questions? 816-774-4050

March 1, 2018

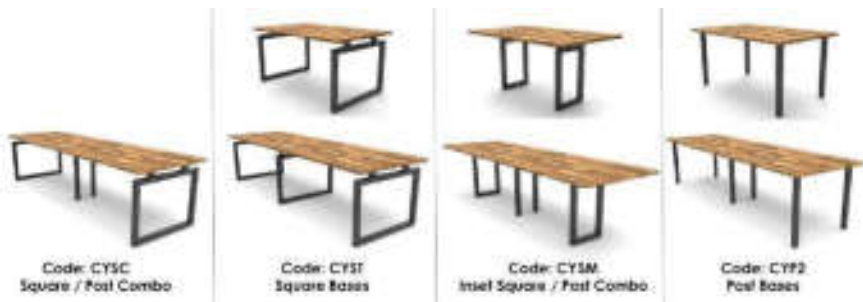

**FINISHES NEEDED:** <http://hi5furniture.com/finishes/>

HPL Top: Hi5 Graded-in laminates or Non-Premium Wilsonart or Formica

Edge Color: Any Hi5 standard

Base Finish: Any Hi5 standard

Table Size	Base Style	Model Code:	# Top Pieces	# of Posts	# of Squares	List Price	List Price	List Price
48 x 72x 29" H	Post Bases	CYP2 487229RES	1	6	0	\$2,940	\$3,240	\$4,310
48 x 72x 29" H	Square/Post Combo	CYSC 487229 RES	1	2	2-48"	\$4,280	\$4,580	\$5,650
48 x 72x 29" H	Inset Square	CYSM 487229 RES	1	0	2-24"	\$3,030	\$3,330	\$4,400
48 x 72x 29" H	Square Bases	CYST 487229RES	1	0	3-48"	\$4,950	\$5,250	\$6,320
48 x 72x 36" H	Post Bases	CYP2 487236RES	1	6	0	\$3,000	\$3,300	\$4,370
48 x 72x 36" H	Square/Post Combo	CYSC 487236 RES	1	2	2-48"	\$4,420	\$4,720	\$5,790
48 x 72x 36" H	Inset Square	CYSM 487236 RES	1	0	2-24"	\$3,210	\$3,510	\$4,580
48 x 72x 36" H	Square Bases	CYST 487236RES	1	0	3-48"	\$5,130	\$5,430	\$6,500
48 x 72x 42" H	Post Bases	CYP2 487242RES	1	6	0	\$3,060	\$3,360	\$4,430
48 x 72x 42" H	Square/Post Combo	CYSC 487242 RES	1	2	2-48"	\$4,560	\$4,860	\$5,930
48 x 72x 42" H	Inset Square	CYSM 487242 RES	1	0	2-24"	\$3,390	\$3,690	\$4,760
48 x 72x 42" H	Square Bases	CYST 487242RES	1	0	3-48"	\$5,310	\$5,610	\$6,680
48 x 84x 29" H	Post Bases	CYP2 488489RES	1	6	0	\$3,140	\$3,500	\$4,580
48 x 84x 29" H	Square/Post Combo	CYSC 488489 RES	1	2	2-48"	\$4,480	\$4,840	\$5,920
48 x 84x 29" H	Inset Square	CYSM 488489 RES	1	0	2-24"	\$3,230	\$3,590	\$4,670
48 x 84x 29" H	Square Bases	CYST 488489RES	1	0	3-48"	\$5,150	\$5,510	\$6,590
48 x 84x 36" H	Post Bases	CYP2 488436RES	1	6	0	\$3,200	\$3,560	\$4,640
48 x 84x 36" H	Square/Post Combo	CYSC 488436 RES	1	2	2-48"	\$4,620	\$4,980	\$6,060
48 x 84x 36" H	Inset Square	CYSM 488436 RES	1	0	2-24"	\$3,410	\$3,770	\$4,850
48 x 84x 36" H	Square Bases	CYST 488436RES	1	0	3-48"	\$5,330	\$5,690	\$6,770
48 x 84x 42" H	Post Bases	CYP2 488442RES	1	6	0	\$3,260	\$3,620	\$4,700
48 x 84x 42" H	Square/Post Combo	CYSC 488442 RES	1	2	2-48"	\$4,760	\$5,120	\$6,200
48 x 84x 42" H	Inset Square	CYSM 488442 RES	1	0	2-24"	\$3,590	\$3,950	\$5,030
48 x 84x 42" H	Square Bases	CYST 488442RES	1	0	3-48"	\$5,510	\$5,870	\$6,950

POWER & A/V OPTIONS SEE PAGES 8-20

**TABLE OPTIONS:**

Laser cut holes in base - 1.5" x 2.5"

Grommet

WB  
G (B | S)

\$100 list per table

\$20 list per table



# Coby Square – 48" deep

www.hi5furniture.com Questions? 816-774-4050

March 1, 2018

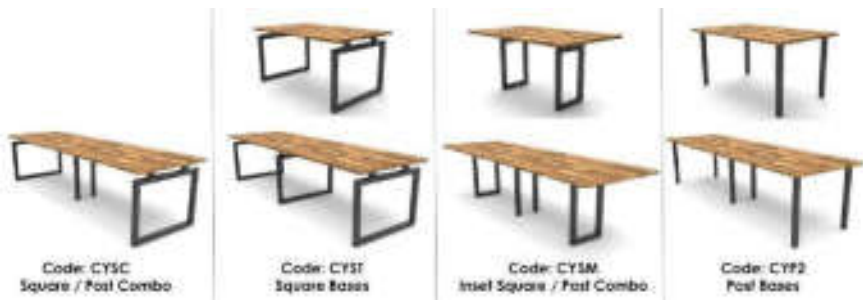

HPL Top Self edges <b>Suffix L6</b>	HPL Top Wood edges <b>Suffix L20</b>	HPL Top Plywood edges <b>Suffix L17</b>	
HPL Top 3mm PVC <b>Suffix L3</b>	HPL Top Knife PVC <b>Suffix L11</b>	HPL Top Knife Wood <b>Suffix L33</b>	HPL Top Knife Plywood <b>Suffix L18</b>

**FINISHES NEEDED:** <http://hi5furniture.com/finishes/>

HPL Top: Hi5 Graded-in laminates or Non-Premium Wilsonart or Formica

Edge Color: Any Hi5 standard

Base Finish: Any Hi5 standard

Table Size	Base Style	Model Code:	# Top Pieces	# of Posts	# of Squares	List Price	List Price	List Price
48 x 96x 29" H	Post Bases	CYP2 489629RES	1	6	0	\$3,160	\$3,525	\$4,660
48 x 96x 29" H	Square/Post Combo	CYSC 489629 RES	1	2	2-48"	\$4,500	\$4,865	\$6,000
48 x 96x 29" H	Inset Square	CYSM 489629 RES	1	0	2-24"	\$3,250	\$3,615	\$4,750
48 x 96x 29" H	Square Bases	CYST 489629RES	1	0	3-48"	\$5,170	\$5,535	\$6,670
48 x 96x 36" H	Post Bases	CYP2 489636RES	1	6	0	\$3,220	\$3,585	\$4,720
48 x 96x 36" H	Square/Post Combo	CYSC 489636 RES	1	2	2-48"	\$4,640	\$5,005	\$6,140
48 x 96x 36" H	Inset Square	CYSM 489636 RES	1	0	2-24"	\$3,430	\$3,795	\$4,930
48 x 96x 36" H	Square Bases	CYST 489636RES	1	0	3-48"	\$5,350	\$5,715	\$6,850
48 x 96x 42" H	Post Bases	CYP2 489642RES	1	6	0	\$3,280	\$3,645	\$4,780
48 x 96x 42" H	Square/Post Combo	CYSC 489642 RES	1	2	2-48"	\$4,780	\$5,145	\$6,280
48 x 96x 42" H	Inset Square	CYSM 489642 RES	1	0	2-24"	\$3,610	\$3,975	\$5,110
48 x 96x 42" H	Square Bases	CYST 489642RES	1	0	3-48"	\$5,530	\$5,895	\$7,030
48 x 108x 29" H	Post Bases	CYP2 4810829RES	1	6	0	\$3,360	\$4,065	\$4,930
48 x 108x 29" H	Square/Post Combo	CYSC 4810829 RES	1	2	2-48"	\$4,700	\$5,405	\$6,270
48 x 108x 29" H	Inset Combo	CYSM 4810829 RES	1	2	2-24"	\$4,100	\$4,805	\$5,670
48 x 108x 29" H	Square Bases	CYST 4810829RES	1	0	3-48"	\$5,370	\$6,075	\$6,940
48 x 108x 36" H	Post Bases	CYP2 4810836RES	1	6	0	\$3,420	\$4,125	\$4,990
48 x 108x 36" H	Square/Post Combo	CYSC 4810836 RES	1	2	2-48"	\$4,840	\$5,545	\$6,410
48 x 108x 36" H	Inset Combo	CYSM 4810836 RES	1	2	2-24"	\$4,300	\$5,005	\$5,870
48 x 108x 36" H	Square Bases	CYST 4810836RES	1	0	3-48"	\$5,550	\$6,255	\$7,120
48 x 108x 42" H	Post Bases	CYP2 4810842RES	1	6	0	\$3,480	\$4,185	\$5,050
48 x 108x 42" H	Square/Post Combo	CYSC 4810842 RES	1	2	2-48"	\$4,980	\$5,685	\$6,550
48 x 108x 42" H	Inset Combo	CYSM 4810842 RES	1	2	2-24"	\$4,500	\$5,205	\$6,070
48 x 108x 42" H	Square Bases	CYST 4810842RES	1	0	3-48"	\$5,730	\$6,435	\$7,300

POWER & A/V OPTIONS SEE PAGES 8-20

**TABLE OPTIONS:**

Laser cut holes in base - 1.5" x 2.5"

Grommet

WB  
G (B|S)

\$100 list per table

\$20 list per table

# Coby Square – 48" deep

www.hi5furniture.com Questions? 816-774-4050

March 1, 2018

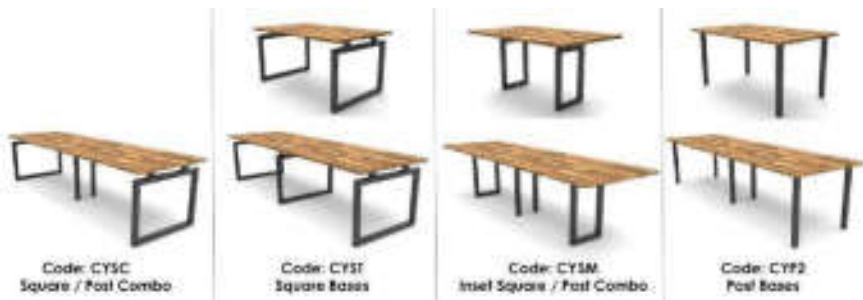

HPL Top Self edges <b>Suffix L6</b>	HPL Top Wood edges <b>Suffix L20</b>	HPL Top Plywood edges <b>Suffix L17</b>	
HPL Top 3mm PVC <b>Suffix L3</b>	HPL Top Knife PVC <b>Suffix L11</b>	HPL Top Knife Wood <b>Suffix L33</b>	HPL Top Knife Plywood <b>Suffix L18</b>

**FINISHES NEEDED:** <http://hi5furniture.com/finishes/>

HPL Top: Hi5 Graded-in laminates or Non-Premium Wilsonart or Formica

Edge Color: Any Hi5 standard

Base Finish: Any Hi5 standard

Table Size	Base Style	Model Code:	# Top Pieces	# of Posts	# of Squares	List Price	List Price	List Price
48 x 120x 29" H	Post Bases	CYP2 4812029RES	1	6	0	\$3,380	\$4,095	\$5,010
48 x 120x 29" H	Square/Post Combo	CYSC 4812029RES	1	2	2-48"	\$4,720	\$5,435	\$6,350
48 x 120x 29" H	Inset Combo	CYSM 4812029RES	1	2	2-24"	\$4,120	\$4,835	\$5,750
48 x 120x 29" H	Square Bases	CYST 4812029RES	1	0	3-48"	\$5,390	\$6,105	\$7,020
48 x 120x 36" H	Post Bases	CYP2 4812036RES	1	6	0	\$3,440	\$4,155	\$5,070
48 x 120x 36" H	Square/Post Combo	CYSC 4812036RES	1	2	2-48"	\$4,860	\$5,575	\$6,490
48 x 120x 36" H	Inset Combo	CYSM 4812036RES	1	2	2-24"	\$4,320	\$5,035	\$5,950
48 x 120x 36" H	Square Bases	CYST 4812036RES	1	0	3-48"	\$5,570	\$6,285	\$7,200
48 x 120x 42" H	Post Bases	CYP2 4812042RES	1	6	0	\$3,500	\$4,215	\$5,130
48 x 120x 42" H	Square/Post Combo	CYSC 4812042RES	1	2	2-48"	\$5,000	\$5,715	\$6,630
48 x 120x 42" H	Inset Combo	CYSM 4812042RES	1	2	2-24"	\$4,520	\$5,235	\$6,150
48 x 120x 42" H	Square Bases	CYST 4812042RES	1	0	3-48"	\$5,750	\$6,465	\$7,380
48 x 132x 29" H	Post Bases	CYP2 4813229RES	2	10	0	\$5,820	\$7,105	\$8,200
48 x 132x 29" H	Square/Post Combo	CYSC 4813229RES	2	6	2-48"	\$7,160	\$8,445	\$9,540
48 x 132x 29" H	Inset Combo	CYSM 4813229RES	2	4	2-24"	\$5,910	\$7,195	\$8,290
48 x 132x 29" H	Square Bases	CYST 4813229RES	2	0	5-48"	\$9,170	\$10,455	\$11,550
48 x 132x 36" H	Post Bases	CYP2 4813236RES	2	10	0	\$5,920	\$7,205	\$8,300
48 x 132x 36" H	Square/Post Combo	CYSC 4813236RES	2	6	2-48"	\$7,340	\$8,625	\$9,720
48 x 132x 36" H	Inset Combo	CYSM 4813236RES	2	4	2-24"	\$6,130	\$7,415	\$8,510
48 x 132x 36" H	Square Bases	CYST 4813236RES	2	0	5-48"	\$9,470	\$10,755	\$11,850
48 x 132x 42" H	Post Bases	CYP2 4813242RES	2	10	0	\$6,020	\$7,305	\$8,400
48 x 132x 42" H	Square/Post Combo	CYSC 4813242RES	2	6	2-48"	\$7,520	\$8,805	\$9,900
48 x 132x 42" H	Inset Combo	CYSM 4813242RES	2	4	2-24"	\$6,350	\$7,635	\$8,730
48 x 132x 42" H	Square Bases	CYST 4813242RES	2	0	5-48"	\$9,770	\$11,055	\$12,150

POWER & A/V OPTIONS SEE PAGES 8-20

**TABLE OPTIONS:**

Laser cut holes in base - 1.5" x 2.5"

Grommet

WB  
G (B | S)

\$100 list per table

\$20 list per table

# Coby Square – 48" deep

www.hi5furniture.com Questions? 816-774-4050

March 1, 2018

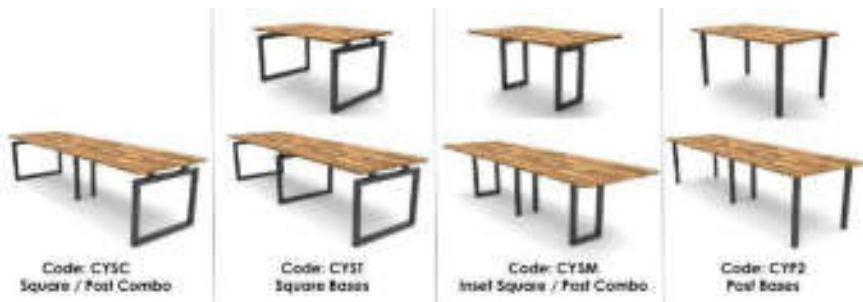

**FINISHES NEEDED:** <http://hi5furniture.com/finishes/>

HPL Top: Hi5 Graded-in laminates or Non-Premium Wilsonart or Formica

Edge Color: Any Hi5 standard

Base Finish: Any Hi5 standard

Table Size	Base Style	Model Code:	# Top Pieces	# of Posts	# of Squares	List Price	List Price	List Price
48 x 144x 29" H	Post Bases	CYP2 4814429RES	2	10	0	\$5,890	\$7,210	\$8,590
48 x 144x 29" H	Square/Post Combo	CYSC 4814429RES	2	6	2-48"	\$7,230	\$8,550	\$9,930
48 x 144x 29" H	Inset Combo	CYSM 4814429RES	2	4	2-24"	\$5,980	\$7,300	\$8,680
48 x 144x 29" H	Square Bases	CYST 4814429RES	2	0	5-48"	\$9,240	\$10,560	\$11,940
48 x 144x 36" H	Post Bases	CYP2 4814436RES	2	10	0	\$5,990	\$7,310	\$8,690
48 x 144x 36" H	Square/Post Combo	CYSC 4814436RES	2	6	2-48"	\$7,410	\$8,730	\$10,110
48 x 144x 36" H	Inset Combo	CYSM 4814436RES	2	4	2-24"	\$6,200	\$7,520	\$8,900
48 x 144x 36" H	Square Bases	CYST 4814436RES	2	0	5-48"	\$9,540	\$10,860	\$12,240
48 x 144x 42" H	Post Bases	CYP2 4814442RES	2	10	0	\$6,090	\$7,410	\$8,790
48 x 144x 42" H	Square/Post Combo	CYSC 4814442RES	2	6	2-48"	\$7,590	\$8,910	\$10,290
48 x 144x 42" H	Inset Combo	CYSM 4814442RES	2	4	2-24"	\$6,420	\$7,740	\$9,120
48 x 144x 42" H	Square Bases	CYST 4814442RES	2	0	5-48"	\$9,840	\$11,160	\$12,540
48 x 168x 29" H	Post Bases	CYP2 4816829RES	2	10	0	\$6,250	\$7,750	\$9,070
48 x 168x 29" H	Square/Post Combo	CYSC 4816829RES	2	6	2-48"	\$7,590	\$9,090	\$10,410
48 x 168x 29" H	Inset Combo	CYSM 4816829RES	2	6	2-24"	\$6,990	\$8,490	\$9,810
48 x 168x 29" H	Square Bases	CYST 4816829RES	2	0	5-48"	\$9,600	\$11,100	\$12,420
48 x 168x 36" H	Post Bases	CYP2 4816836RES	2	10	0	\$6,350	\$7,850	\$9,170
48 x 168x 36" H	Square/Post Combo	CYSC 4816836RES	2	6	2-48"	\$7,770	\$9,270	\$10,590
48 x 168x 36" H	Inset Combo	CYSM 4816836RES	2	6	2-24"	\$7,230	\$8,730	\$10,050
48 x 168x 36" H	Square Bases	CYST 4816836RES	2	0	5-48"	\$9,900	\$11,400	\$12,720
48 x 168x 42" H	Post Bases	CYP2 4816842RES	2	10	0	\$6,450	\$7,950	\$9,270
48 x 168x 42" H	Square/Post Combo	CYSC 4816842RES	2	6	2-48"	\$7,950	\$9,450	\$10,770
48 x 168x 42" H	Inset Combo	CYSM 4816842RES	2	6	2-24"	\$7,470	\$8,970	\$10,290
48 x 168x 42" H	Square Bases	CYST 4816842RES	2	0	5-48"	\$10,200	\$11,700	\$13,020

POWER & A/V OPTIONS SEE PAGES 8-20

**TABLE OPTIONS:**

Laser cut holes in base - 1.5" x 2.5"

Grommet

WB  
G (B|S)

\$100 list per table

\$20 list per table

# Coby Square – 48" deep

www.hi5furniture.com Questions? 816-774-4050

March 1, 2018

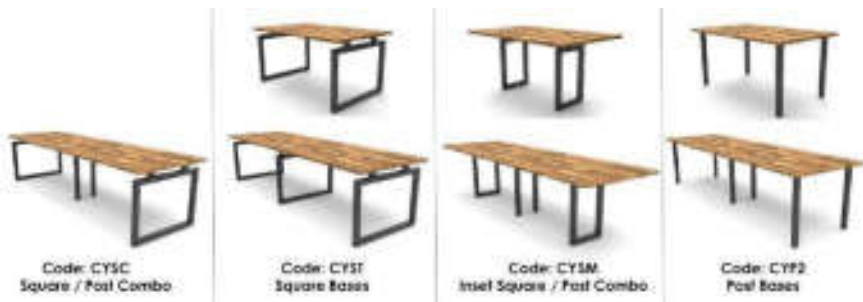

HPL Top Self edges <b>Suffix L6</b>	HPL Top Wood edges <b>Suffix L20</b>	HPL Top Plywood edges <b>Suffix L17</b>	
HPL Top 3mm PVC <b>Suffix L3</b>	HPL Top Knife PVC <b>Suffix L11</b>	HPL Top Knife Wood <b>Suffix L33</b>	HPL Top Knife Plywood <b>Suffix L18</b>

**FINISHES NEEDED:** <http://hi5furniture.com/finishes/>

HPL Top: Hi5 Graded-in laminates or Non-Premium Wilsonart or Formica

Edge Color: Any Hi5 standard

Base Finish: Any Hi5 standard

Table Size	Base Style	Model Code:	# Top Pieces	# of Posts	# of Squares	List Price	List Price	List Price
48 x 192x 29" H	Post Bases	CYP2 4819229RES	2	10	0	\$6,280	\$7,795	\$9,230
48 x 192x 29" H	Square/Post Combo	CYSC 4819229RES	2	6	2-48"	\$7,620	\$9,135	\$10,570
48 x 192x 29" H	Inset Combo	CYSM 4819229RES	2	6	2-24"	\$7,020	\$8,535	\$9,970
48 x 192x 29" H	Square Bases	CYST 4819229RES	2	0	5-48"	\$9,630	\$11,145	\$12,580
48 x 192x 36" H	Post Bases	CYP2 4819236RES	2	10	0	\$6,380	\$7,895	\$9,330
48 x 192x 36" H	Square/Post Combo	CYSC 4819236RES	2	6	2-48"	\$7,800	\$9,315	\$10,750
48 x 192x 36" H	Inset Combo	CYSM 4819236RES	2	6	2-24"	\$7,260	\$8,775	\$10,210
48 x 192x 36" H	Square Bases	CYST 4819236RES	2	0	5-48"	\$9,930	\$11,445	\$12,880
48 x 192x 42" H	Post Bases	CYP2 4819242RES	2	10	0	\$6,480	\$7,995	\$9,430
48 x 192x 42" H	Square/Post Combo	CYSC 4819242RES	2	6	2-48"	\$7,980	\$9,495	\$10,930
48 x 192x 42" H	Inset Combo	CYSM 4819242RES	2	6	2-24"	\$7,500	\$9,015	\$10,450
48 x 192x 42" H	Square Bases	CYST 4819242RES	2	0	5-48"	\$10,230	\$11,745	\$13,180
48 x 216x 29" H	Post Bases	CYP2 4821629RES	2	10	0	\$6,640	\$8,335	\$9,710
48 x 216x 29" H	Square/Post Combo	CYSC 4821629RES	2	6	2-48"	\$7,980	\$9,675	\$11,050
48 x 216x 29" H	Inset Combo	CYSM 4821629RES	2	6	2-24"	\$7,380	\$9,075	\$10,450
48 x 216x 29" H	Square Bases	CYST 4821629RES	2	0	5-48"	\$9,990	\$11,685	\$13,060
48 x 216x 36" H	Post Bases	CYP2 4821636RES	2	10	0	\$6,740	\$8,435	\$9,810
48 x 216x 36" H	Square/Post Combo	CYSC 4821636RES	2	6	2-48"	\$8,160	\$9,855	\$11,230
48 x 216x 36" H	Inset Combo	CYSM 4821636RES	2	6	2-24"	\$7,620	\$9,315	\$10,690
48 x 216x 36" H	Square Bases	CYST 4821636RES	2	0	5-48"	\$10,290	\$11,985	\$13,360
48 x 216x 42" H	Post Bases	CYP2 4821642RES	2	10	0	\$6,840	\$8,535	\$9,910
48 x 216x 42" H	Square/Post Combo	CYSC 4821642RES	2	6	2-48"	\$8,340	\$10,035	\$11,410
48 x 216x 42" H	Inset Combo	CYSM 4821642RES	2	6	2-24"	\$7,860	\$9,555	\$10,930
48 x 216x 42" H	Square Bases	CYST 4821642RES	2	0	5-48"	\$10,590	\$12,285	\$13,660

POWER & A/V OPTIONS SEE PAGES 8-20

TABLE OPTIONS:

Laser cut holes in base - 1.5" x 2.5"

Grommet

WB  
G (B|S)

\$100 list per table

\$20 list per table

# Coby Square – 48" deep

www.hi5furniture.com Questions? 816-774-4050

March 1, 2018

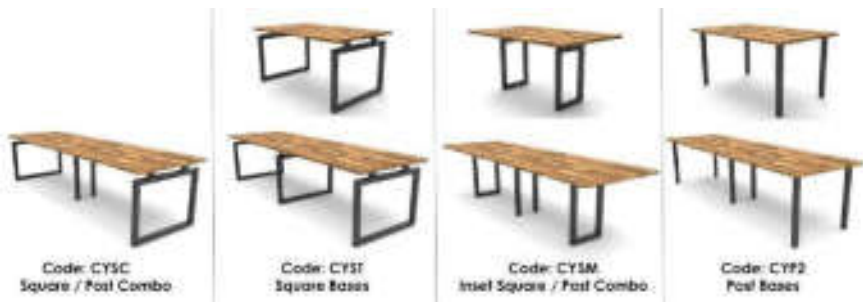

**FINISHES NEEDED:** <http://hi5furniture.com/finishes/>

HPL Top: Hi5 Graded-in laminates or Non-Premium Wilsonart or Formica

Edge Color: Any Hi5 standard

Base Finish: Any Hi5 standard

Table Size	Base Style	Model Code:	# Top Pieces	# of Posts	# of Squares	List Price	List Price	List Price
48 x 240x 29" H	Post Bases	CYP2 4824029RES	2	10	0	\$6,670	\$8,380	\$9,860
48 x 240x 29" H	Square/Post Combo	CYSC 4824029RES	2	6	2-48"	\$8,010	\$9,720	\$11,200
48 x 240x 29" H	Inset Combo	CYSM 4824029RES	2	6	2-24"	\$7,410	\$9,120	\$10,600
48 x 240x 29" H	Square Bases	CYST 4824029RES	2	0	5-48"	\$10,020	\$11,730	\$13,210
48 x 240x 36" H	Post Bases	CYP2 4824036RES	2	10	0	\$6,770	\$8,480	\$9,960
48 x 240x 36" H	Square/Post Combo	CYSC 4824036RES	2	6	2-48"	\$8,190	\$9,900	\$11,380
48 x 240x 36" H	Inset Combo	CYSM 4824036RES	2	6	2-24"	\$7,650	\$9,360	\$10,840
48 x 240x 36" H	Square Bases	CYST 4824036RES	2	0	5-48"	\$10,320	\$12,030	\$13,510
48 x 240x 42" H	Post Bases	CYP2 4824042RES	2	10	0	\$6,870	\$8,580	\$10,060
48 x 240x 42" H	Square/Post Combo	CYSC 4824042RES	2	6	2-48"	\$8,370	\$10,080	\$11,560
48 x 240x 42" H	Inset Combo	CYSM 4824042RES	2	6	2-24"	\$7,890	\$9,600	\$11,080
48 x 240x 42" H	Square Bases	CYST 4824042RES	2	0	5-48"	\$10,620	\$12,330	\$13,810

POWER & A/V OPTIONS SEE PAGES 8-20

**TABLE OPTIONS:**

Laser cut holes in base - 1.5" x 2.5"

Grommet

WB  
G (B|S)

\$100 list per table  
\$20 list per table

# Coby Square – 60" deep

www.hi5furniture.com Questions? 816-774-4050

March 1, 2018

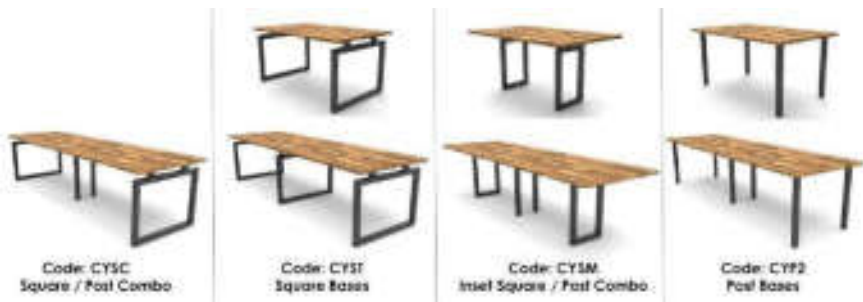

HPL Top Self edges <b>Suffix L6</b>	HPL Top Wood edges <b>Suffix L20</b>	HPL Top Plywood edges <b>Suffix L17</b>	
HPL Top 3mm PVC <b>Suffix L3</b>	HPL Top Knife PVC <b>Suffix L11</b>	HPL Top Knife Wood <b>Suffix L33</b>	HPL Top Knife Plywood <b>Suffix L18</b>

**FINISHES NEEDED:** <http://hi5furniture.com/finishes/>

HPL Top: Hi5 Graded-in laminates or Non-Premium Wilsonart or Formica

Edge Color: Any Hi5 standard

Base Finish: Any Hi5 standard

Table Size	Base Style	Model Code:	# Top Pieces	# of Posts	# of Squares	List Price	List Price	List Price
60 x 72x 29" H	Post Bases	CYP2 607229RES	1	6	0	\$3,110	\$3,690	\$4,530
60 x 72x 29" H	Square/Post Combo	CYSC 607229RES	1	2	2-60"	\$4,570	\$5,150	\$5,990
60 x 72x 29" H	Inset Square	CYSM 607229RES	1	0	2-30"	\$3,320	\$3,900	\$4,740
60 x 72x 29" H	Square Bases	CYST 607229RES	1	0	3-60"	\$5,300	\$5,880	\$6,720
60 x 72x 36" H	Post Bases	CYP2 607260RES	1	6	0	\$3,170	\$3,750	\$4,590
60 x 72x 36" H	Square/Post Combo	CYSC 607260RES	1	2	2-60"	\$4,710	\$5,290	\$6,130
60 x 72x 36" H	Inset Square	CYSM 607260RES	1	0	2-30"	\$3,500	\$4,080	\$4,920
60 x 72x 36" H	Square Bases	CYST 607260RES	1	0	3-60"	\$5,480	\$6,060	\$6,900
60 x 72x 42" H	Post Bases	CYP2 607260RES	1	6	0	\$3,230	\$3,810	\$4,650
60 x 72x 42" H	Square/Post Combo	CYSC 607260RES	1	2	2-60"	\$4,850	\$5,430	\$6,270
60 x 72x 42" H	Inset Square	CYSM 607260RES	1	0	2-30"	\$3,680	\$4,260	\$5,100
60 x 72x 42" H	Square Bases	CYST 607260RES	1	0	3-60"	\$5,660	\$6,240	\$7,080
60 x 84x 29" H	Post Bases	CYP2 608609RES	1	6	0	\$3,360	\$4,065	\$4,850
60 x 84x 29" H	Square/Post Combo	CYSC 608609RES	1	2	2-60"	\$4,820	\$5,525	\$6,310
60 x 84x 29" H	Inset Square	CYSM 608609RES	1	0	2-30"	\$3,570	\$4,275	\$5,060
60 x 84x 29" H	Square Bases	CYST 608609RES	1	0	3-60"	\$5,550	\$6,255	\$7,040
60 x 84x 36" H	Post Bases	CYP2 608436RES	1	6	0	\$3,420	\$4,125	\$4,910
60 x 84x 36" H	Square/Post Combo	CYSC 608436RES	1	2	2-60"	\$4,960	\$5,665	\$6,450
60 x 84x 36" H	Inset Square	CYSM 608436RES	1	0	2-30"	\$3,750	\$4,455	\$5,240
60 x 84x 36" H	Square Bases	CYST 608436RES	1	0	3-60"	\$5,730	\$6,435	\$7,220
60 x 84x 42" H	Post Bases	CYP2 608460RES	1	6	0	\$3,480	\$4,185	\$4,970
60 x 84x 42" H	Square/Post Combo	CYSC 608460RES	1	2	2-60"	\$5,100	\$5,805	\$6,590
60 x 84x 42" H	Inset Square	CYSM 608460RES	1	0	2-30"	\$3,930	\$4,635	\$5,420
60 x 84x 42" H	Square Bases	CYST 608460RES	1	0	3-60"	\$5,910	\$6,615	\$7,400

POWER & A/V OPTIONS SEE PAGES 8-20

TABLE OPTIONS:

Laser cut holes in base - 1.5" x 2.5"

Grommet

WB  
G (B|S)

\$100 list per table

\$20 list per table

# Coby Square – 60" deep

www.hi5furniture.com Questions? 816-774-4050

March 1, 2018

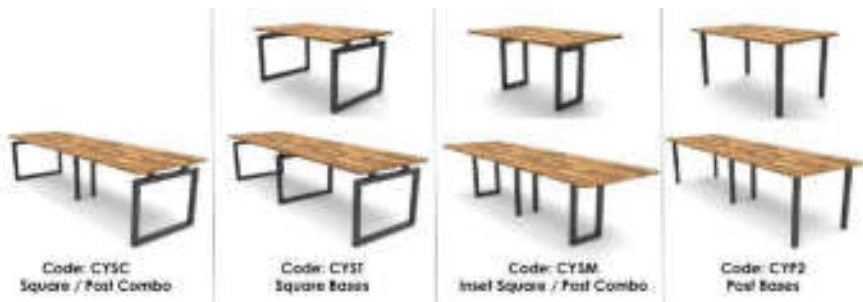

HPL Top Self edges <b>Suffix L6</b>	HPL Top Wood edges <b>Suffix L20</b>	HPL Top Plywood edges <b>Suffix L17</b>	
HPL Top 3mm PVC <b>Suffix L3</b>	HPL Top Knife PVC <b>Suffix L11</b>	HPL Top Knife Wood <b>Suffix L33</b>	HPL Top Knife Plywood <b>Suffix L18</b>

**FINISHES NEEDED:** <http://hi5furniture.com/finishes/>

HPL Top: Hi5 Graded-in laminates or Non-Premium Wilsonart or Formica

Edge Color: Any Hi5 standard

Base Finish: Any Hi5 standard

Table Size	Base Style	Model Code:	# Top Pieces	# of Posts	# of Squares	List Price	List Price	List Price
60 x 96x 29" H	Post Bases	CYP2 609629RES	1	6	0	\$3,370	\$4,080	\$4,930
60 x 96x 29" H	Square/Post Combo	CYSC 609629RES	1	2	2-60"	\$4,830	\$5,540	\$6,390
60 x 96x 29" H	Inset Square	CYSM 609629RES	1	0	2-30"	\$3,580	\$4,290	\$5,140
60 x 96x 29" H	Square Bases	CYST 609629RES	1	0	3-60"	\$5,560	\$6,270	\$7,120
60 x 96x 36" H	Post Bases	CYP2 609660RES	1	6	0	\$3,430	\$4,140	\$4,990
60 x 96x 36" H	Square/Post Combo	CYSC 609660RES	1	2	2-60"	\$4,970	\$5,680	\$6,530
60 x 96x 36" H	Inset Square	CYSM 609660RES	1	0	2-30"	\$3,760	\$4,470	\$5,320
60 x 96x 36" H	Square Bases	CYST 609660RES	1	0	3-60"	\$5,740	\$6,450	\$7,300
60 x 96x 42" H	Post Bases	CYP2 609660RES	1	6	0	\$3,490	\$4,200	\$5,050
60 x 96x 42" H	Square/Post Combo	CYSC 609660RES	1	2	2-60"	\$5,110	\$5,820	\$6,670
60 x 96x 42" H	Inset Square	CYSM 609660RES	1	0	2-30"	\$3,940	\$4,650	\$5,500
60 x 96x 42" H	Square Bases	CYST 609660RES	1	0	3-60"	\$5,920	\$6,630	\$7,480
60 x 108x 29" H	Post Bases	CYP2 6010829RES	1	6	0	\$3,610	\$4,440	\$5,250
60 x 108x 29" H	Square/Post Combo	CYSC 6010829RES	1	2	2-60"	\$5,070	\$5,900	\$6,710
60 x 108x 29" H	Inset Combo	CYSM 6010829RES	1	2	2-30"	\$4,470	\$5,300	\$6,110
60 x 108x 29" H	Square Bases	CYST 6010829RES	1	0	3-60"	\$5,800	\$6,630	\$7,440
60 x 108x 36" H	Post Bases	CYP2 6010860RES	1	6	0	\$3,670	\$4,500	\$5,310
60 x 108x 36" H	Square/Post Combo	CYSC 6010860RES	1	2	2-60"	\$5,210	\$6,040	\$6,850
60 x 108x 36" H	Inset Combo	CYSM 6010860RES	1	2	2-30"	\$4,670	\$5,500	\$6,310
60 x 108x 36" H	Square Bases	CYST 6010860RES	1	0	3-60"	\$5,980	\$6,810	\$7,620
60 x 108x 42" H	Post Bases	CYP2 6010860RES	1	6	0	\$3,730	\$4,560	\$5,370
60 x 108x 42" H	Square/Post Combo	CYSC 6010860RES	1	2	2-60"	\$5,350	\$6,180	\$6,990
60 x 108x 42" H	Inset Combo	CYSM 6010860RES	1	2	2-30"	\$4,870	\$5,700	\$6,510
60 x 108x 42" H	Square Bases	CYST 6010860RES	1	0	3-60"	\$6,160	\$6,990	\$7,800

POWER & A/V OPTIONS SEE PAGES 8-20

**TABLE OPTIONS:**

Laser cut holes in base - 1.5" x 2.5"

Grommet

WB  
G (B|S)

\$100 list per table

\$20 list per table

# Coby Square – 60" deep

www.hi5furniture.com Questions? 816-774-4050

March 1, 2018

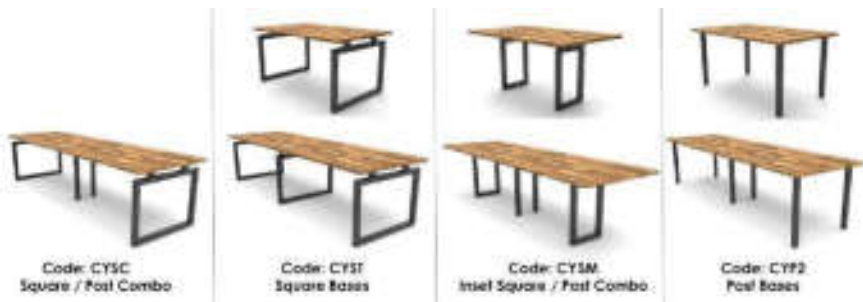

**FINISHES NEEDED:** <http://hi5furniture.com/finishes/>

HPL Top: Hi5 Graded-in laminates or Non-Premium Wilsonart or Formica

Edge Color: Any Hi5 standard

Base Finish: Any Hi5 standard

Table Size	Base Style	Model Code:	# Top Pieces	# of Posts	# of Squares	List Price	List Price	List Price
60 x 120x 29" H	Post Bases	CYP2 6012029RES	1	6	0	\$3,630	\$4,470	\$5,330
60 x 120x 29" H	Square/Post Combo	CYSC 6012029RES	1	2	2-60"	\$5,090	\$5,930	\$6,790
60 x 120x 29" H	Inset Combo	CYSM 6012029RES	1	2	2-30"	\$4,490	\$5,330	\$6,190
60 x 120x 29" H	Square Bases	CYST 6012029RES	1	0	3-60"	\$5,820	\$6,660	\$7,520
60 x 120x 36" H	Post Bases	CYP2 6012060RES	1	6	0	\$3,690	\$4,530	\$5,390
60 x 120x 36" H	Square/Post Combo	CYSC 6012060RES	1	2	2-60"	\$5,230	\$6,070	\$6,930
60 x 120x 36" H	Inset Combo	CYSM 6012060RES	1	2	2-30"	\$4,690	\$5,530	\$6,390
60 x 120x 36" H	Square Bases	CYST 6012060RES	1	0	3-60"	\$6,000	\$6,840	\$7,700
60 x 120x 42" H	Post Bases	CYP2 6012060RES	1	6	0	\$3,750	\$4,590	\$5,450
60 x 120x 42" H	Square/Post Combo	CYSC 6012060RES	1	2	2-60"	\$5,370	\$6,210	\$7,070
60 x 120x 42" H	Inset Combo	CYSM 6012060RES	1	2	2-30"	\$4,890	\$5,730	\$6,590
60 x 120x 42" H	Square Bases	CYST 6012060RES	1	0	3-60"	\$6,180	\$7,020	\$7,880
60 x 132x 29" H	Post Bases	CYP2 6013229RES	2	10	0	\$6,240	\$7,735	\$8,670
60 x 132x 29" H	Square/Post Combo	CYSC 6013229RES	2	6	2-60"	\$7,700	\$9,195	\$10,130
60 x 132x 29" H	Inset Combo	CYSM 6013229RES	2	4	2-30"	\$6,450	\$7,945	\$8,880
60 x 132x 29" H	Square Bases	CYST 6013229RES	2	0	5-60"	\$9,890	\$11,385	\$12,320
60 x 132x 36" H	Post Bases	CYP2 6013260RES	2	10	0	\$6,340	\$7,835	\$8,770
60 x 132x 36" H	Square/Post Combo	CYSC 6013260RES	2	6	2-60"	\$7,880	\$9,375	\$10,310
60 x 132x 36" H	Inset Combo	CYSM 6013260RES	2	4	2-30"	\$6,670	\$8,165	\$9,100
60 x 132x 36" H	Square Bases	CYST 6013260RES	2	0	5-60"	\$10,190	\$11,685	\$12,620
60 x 132x 42" H	Post Bases	CYP2 6013260RES	2	10	0	\$6,440	\$7,935	\$8,870
60 x 132x 42" H	Square/Post Combo	CYSC 6013260RES	2	6	2-60"	\$8,060	\$9,555	\$10,490
60 x 132x 42" H	Inset Combo	CYSM 6013260RES	2	4	2-30"	\$6,890	\$8,385	\$9,320
60 x 132x 42" H	Square Bases	CYST 6013260RES	2	0	5-60"	\$10,490	\$11,985	\$12,920

POWER & A/V OPTIONS SEE PAGES 8-20

**TABLE OPTIONS:**

Laser cut holes in base - 1.5" x 2.5"

Grommet

WB  
G (B|S)

\$100 list per table

\$20 list per table



# Coby Square – 60" deep

www.hi5furniture.com Questions? 816-774-4050

March 1, 2018

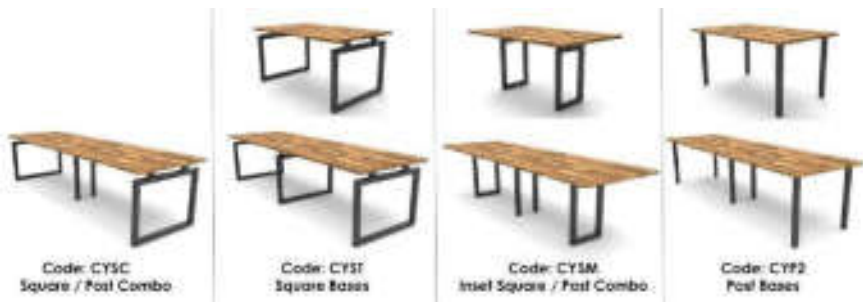

**FINISHES NEEDED:** <http://hi5furniture.com/finishes/>

HPL Top: Hi5 Graded-in laminates or Non-Premium Wilsonart or Formica

Edge Color: Any Hi5 standard

Base Finish: Any Hi5 standard

Table Size	Base Style	Model Code:	# Top Pieces	# of Posts	# of Squares	List Price	List Price	List Price
60 x 144x 29" H	Post Bases	CYP2 6014609RES	2	10	0	\$6,330	\$7,870	\$9,140
60 x 144x 29" H	Square/Post Combo	CYSC 6014609RES	2	6	2-60"	\$7,790	\$9,330	\$10,600
60 x 144x 29" H	Inset Combo	CYSM 6014609RES	2	4	2-30"	\$6,540	\$8,080	\$9,350
60 x 144x 29" H	Square Bases	CYST 6014609RES	2	0	5-60"	\$9,980	\$11,520	\$12,790
60 x 144x 36" H	Post Bases	CYP2 6014460RES	2	10	0	\$6,430	\$7,970	\$9,240
60 x 144x 36" H	Square/Post Combo	CYSC 6014460RES	2	6	2-60"	\$7,970	\$9,510	\$10,780
60 x 144x 36" H	Inset Combo	CYSM 6014460RES	2	4	2-30"	\$6,760	\$8,300	\$9,570
60 x 144x 36" H	Square Bases	CYST 6014460RES	2	0	5-60"	\$10,280	\$11,820	\$13,090
60 x 144x 42" H	Post Bases	CYP2 6014460RES	2	10	0	\$6,530	\$8,070	\$9,340
60 x 144x 42" H	Square/Post Combo	CYSC 6014460RES	2	6	2-60"	\$8,150	\$9,690	\$10,960
60 x 144x 42" H	Inset Combo	CYSM 6014460RES	2	4	2-30"	\$6,980	\$8,520	\$9,790
60 x 144x 42" H	Square Bases	CYST 6014460RES	2	0	5-60"	\$10,580	\$12,120	\$13,390
60 x 168x 29" H	Post Bases	CYP2 6016829RES	2	10	0	\$6,780	\$8,545	\$9,700
60 x 168x 29" H	Square/Post Combo	CYSC 6016829RES	2	6	2-60"	\$8,240	\$10,005	\$11,160
60 x 168x 29" H	Inset Combo	CYSM 6016829RES	2	6	2-30"	\$7,640	\$9,405	\$10,560
60 x 168x 29" H	Square Bases	CYST 6016829RES	2	0	5-60"	\$10,430	\$12,195	\$13,350
60 x 168x 36" H	Post Bases	CYP2 6016860RES	2	10	0	\$6,880	\$8,645	\$9,800
60 x 168x 36" H	Square/Post Combo	CYSC 6016860RES	2	6	2-60"	\$8,420	\$10,185	\$11,340
60 x 168x 36" H	Inset Combo	CYSM 6016860RES	2	6	2-30"	\$7,880	\$9,645	\$10,800
60 x 168x 36" H	Square Bases	CYST 6016860RES	2	0	5-60"	\$10,730	\$12,495	\$13,650
60 x 168x 42" H	Post Bases	CYP2 6016860RES	2	10	0	\$6,980	\$8,745	\$9,900
60 x 168x 42" H	Square/Post Combo	CYSC 6016860RES	2	6	2-60"	\$8,600	\$10,365	\$11,520
60 x 168x 42" H	Inset Combo	CYSM 6016860RES	2	6	2-30"	\$8,120	\$9,885	\$11,040
60 x 168x 42" H	Square Bases	CYST 6016860RES	2	0	5-60"	\$11,030	\$12,795	\$13,950

POWER & A/V OPTIONS SEE PAGES 8-20

**TABLE OPTIONS:**

Laser cut holes in base - 1.5" x 2.5"

Grommet

WB  
G (B|S)

\$100 list per table

\$20 list per table

# Coby Square – 60" deep

www.hi5furniture.com Questions? 816-774-4050

March 1, 2018

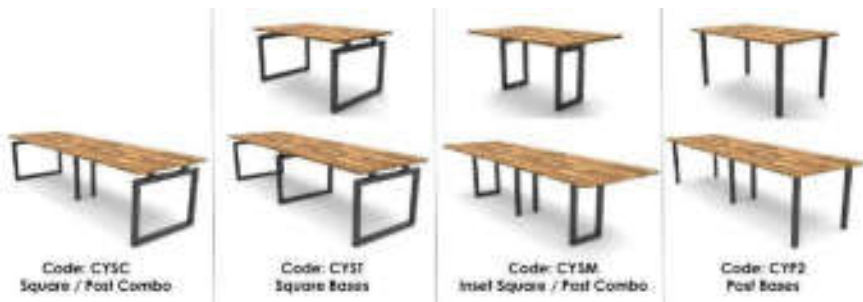

HPL Top Self edges <b>Suffix L6</b>	HPL Top Wood edges <b>Suffix L20</b>	HPL Top Plywood edges <b>Suffix L17</b>	
HPL Top 3mm PVC <b>Suffix L3</b>	HPL Top Knife PVC <b>Suffix L11</b>	HPL Top Knife Wood <b>Suffix L33</b>	HPL Top Knife Plywood <b>Suffix L18</b>

**FINISHES NEEDED:** <http://hi5furniture.com/finishes/>

HPL Top: Hi5 Graded-in laminates or Non-Premium Wilsonart or Formica

Edge Color: Any Hi5 standard

Base Finish: Any Hi5 standard

Table Size	Base Style	Model Code:	# Top Pieces	# of Posts	# of Squares	List Price	List Price	List Price
60 x 192x 29" H	Post Bases	CYP2 6019229RES	2	10	0	\$6,810	\$8,590	\$9,850
60 x 192x 29" H	Square/Post Combo	CYSC 6019229RES	2	6	2-60"	\$8,270	\$10,050	\$11,310
60 x 192x 29" H	Inset Combo	CYSM 6019229RES	2	6	2-30"	\$7,670	\$9,450	\$10,710
60 x 192x 29" H	Square Bases	CYST 6019229RES	2	0	5-60"	\$10,460	\$12,240	\$13,500
60 x 192x 36" H	Post Bases	CYP2 6019260RES	2	10	0	\$6,910	\$8,690	\$9,950
60 x 192x 36" H	Square/Post Combo	CYSC 6019260RES	2	6	2-60"	\$8,450	\$10,230	\$11,490
60 x 192x 36" H	Inset Combo	CYSM 6019260RES	2	6	2-30"	\$7,910	\$9,690	\$10,950
60 x 192x 36" H	Square Bases	CYST 6019260RES	2	0	5-60"	\$10,760	\$12,540	\$13,800
60 x 192x 42" H	Post Bases	CYP2 6019260RES	2	10	0	\$7,010	\$8,790	\$10,050
60 x 192x 42" H	Square/Post Combo	CYSC 6019260RES	2	6	2-60"	\$8,630	\$10,410	\$11,670
60 x 192x 42" H	Inset Combo	CYSM 6019260RES	2	6	2-30"	\$8,150	\$9,930	\$11,190
60 x 192x 42" H	Square Bases	CYST 6019260RES	2	0	5-60"	\$11,060	\$12,840	\$14,100
60 x 216x 29" H	Post Bases	CYP2 6021629RES	2	10	0	\$7,260	\$9,265	\$10,410
60 x 216x 29" H	Square/Post Combo	CYSC 6021629RES	2	6	2-60"	\$8,720	\$10,725	\$11,870
60 x 216x 29" H	Inset Combo	CYSM 6021629RES	2	6	2-30"	\$8,120	\$10,125	\$11,270
60 x 216x 29" H	Square Bases	CYST 6021629RES	2	0	5-60"	\$10,910	\$12,915	\$14,060
60 x 216x 36" H	Post Bases	CYP2 6021660RES	2	10	0	\$7,360	\$9,365	\$10,510
60 x 216x 36" H	Square/Post Combo	CYSC 6021660RES	2	6	2-60"	\$8,900	\$10,905	\$12,050
60 x 216x 36" H	Inset Combo	CYSM 6021660RES	2	6	2-30"	\$8,360	\$10,365	\$11,510
60 x 216x 36" H	Square Bases	CYST 6021660RES	2	0	5-60"	\$11,210	\$13,215	\$14,360
60 x 216x 42" H	Post Bases	CYP2 6021660RES	2	10	0	\$7,460	\$9,465	\$10,610
60 x 216x 42" H	Square/Post Combo	CYSC 6021660RES	2	6	2-60"	\$9,080	\$11,085	\$12,230
60 x 216x 42" H	Inset Combo	CYSM 6021660RES	2	6	2-30"	\$8,600	\$10,605	\$11,750
60 x 216x 42" H	Square Bases	CYST 6021660RES	2	0	5-60"	\$11,510	\$13,515	\$14,660

POWER & A/V OPTIONS SEE PAGES 8-20

TABLE OPTIONS:

Laser cut holes in base - 1.5" x 2.5"

Grommet

WB  
G (B|S)

\$100 list per table

\$20 list per table

# Coby Square – 60" deep

www.hi5furniture.com Questions? 816-774-4050

March 1, 2018

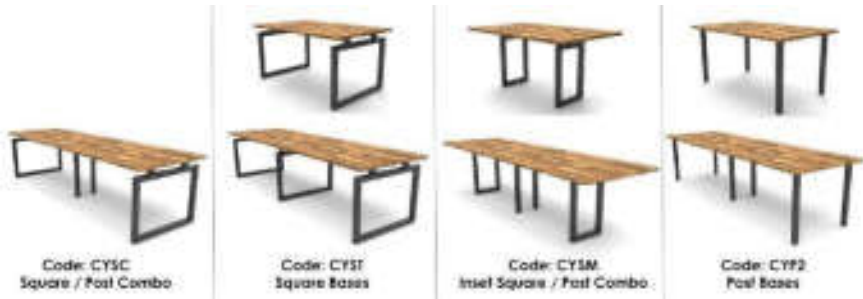

HPL Top Self edges <b>Suffix L6</b>	HPL Top Wood edges <b>Suffix L20</b>	HPL Top Plywood edges <b>Suffix L17</b>	
HPL Top 3mm PVC <b>Suffix L3</b>	HPL Top Knife PVC <b>Suffix L11</b>	HPL Top Knife Wood <b>Suffix L33</b>	HPL Top Knife Plywood <b>Suffix L18</b>

**FINISHES NEEDED:** <http://hi5furniture.com/finishes/>

HPL Top: Hi5 Graded-in laminates or Non-Premium Wilsonart or Formica

Edge Color: Any Hi5 standard

Base Finish: Any Hi5 standard

Table Size	Base Style	Model Code:	# Top Pieces	# of Posts	# of Squares	List Price	List Price	List Price
60 x 240x 29" H	Post Bases	CYP2 6024029RES	2	10	0	\$7,290	\$9,310	\$10,570
60 x 240x 29" H	Square/Post Combo	CYSC 6024029RES	2	6	2-60"	\$8,750	\$10,770	\$12,030
60 x 240x 29" H	Inset Combo	CYSM 6024029RES	2	6	2-30"	\$8,150	\$10,170	\$11,430
60 x 240x 29" H	Square Bases	CYST 6024029RES	2	0	5-60"	\$10,940	\$12,960	\$14,220
60 x 240x 36" H	Post Bases	CYP2 6024060RES	2	10	0	\$7,390	\$9,410	\$10,670
60 x 240x 36" H	Square/Post Combo	CYSC 6024060RES	2	6	2-60"	\$8,930	\$10,950	\$12,210
60 x 240x 36" H	Inset Combo	CYSM 6024060RES	2	6	2-30"	\$8,390	\$10,410	\$11,670
60 x 240x 36" H	Square Bases	CYST 6024060RES	2	0	5-60"	\$11,240	\$13,260	\$14,520
60 x 240x 42" H	Post Bases	CYP2 6024060RES	2	10	0	\$7,490	\$9,510	\$10,770
60 x 240x 42" H	Square/Post Combo	CYSC 6024060RES	2	6	2-60"	\$9,110	\$11,130	\$12,390
60 x 240x 42" H	Inset Combo	CYSM 6024060RES	2	6	2-30"	\$8,630	\$10,650	\$11,910
60 x 240x 42" H	Square Bases	CYST 6024060RES	2	0	5-60"	\$11,540	\$13,560	\$14,820

POWER & A/V OPTIONS SEE PAGES 8-20

**TABLE OPTIONS:**

Laser cut holes in base - 1.5" x 2.5"

Grommet

WB  
G (B|S)

\$100 list per table

\$20 list per table



**AS OF 2021  
PRODUCT UPDATE  
See Hi5Furniture.com  
For Offering & Pricing**

**FINISHES NEEDED:** <http://hi5furniture.com/finishes/>

HPL Top: Hi5 Graded-in laminates or Non-Premium Wilsonart or Formica

Edge Color: Any Hi5 standard

Base Finish: Black or Silver ONLY

HPL Top 3mm PVC Suffix L3	HPL Top Knife PVC Suffix L11	HPL Top Knife Wood Suffix L33	HPL Top Plywood edges Suffix L17

Table Size	Top Shape	Table Function	Model Code:	Base Size	Base Style				
24"	round	Hand crank	27.25" - 36.75"	EEX1 24RD H	22"	X	\$1,675	\$1,905	\$2,465
24"	round	Pneumatic	27.25" - 45"	EEX1 24RD P	22"	X	\$2,135	\$2,365	\$2,925
24"	round	Stationary		EEX1 24RD S	22"	X	\$1,150	\$1,380	\$1,940
30"	round	Hand crank	27.25" - 36.75"	EEX1 30RD H	22"	X	\$1,725	\$1,980	\$2,585
30"	round	Pneumatic	27.25" - 45"	EEX1 30RD P	22"	X	\$2,185	\$2,440	\$3,045
30"	round	Stationary		EEX1 30RD S	22"	X	\$1,200	\$1,455	\$2,060
36"	round	Hand crank	27.25" - 36.75"	EEX1 36RD H	26"	X	\$1,795	\$2,085	\$2,715
36"	round	Pneumatic	27.25" - 45"	EEX1 36RD P	26"	X	\$2,280	\$2,570	\$3,200
36"	round	Stationary		EEX1 36RD S	26"	X	\$1,270	\$1,560	\$2,190
42"	round	Pneumatic	27.25" - 45"	EEX1 42RD P	32"	X	\$2,455	\$2,820	\$3,455
42"	round	Stationary		EEX1 42RD S	32"	X	\$1,440	\$1,805	\$2,440
48"	round	Pneumatic	27.25" - 45"	EEX1 48RD P	36"	X	\$2,490	\$2,860	\$3,540
48"	round	Stationary		EEX1 48RD S	36"	X	\$1,475	\$1,845	\$2,525
24"	square	Pneumatic	27.25" - 45"	EEX1 24SQ P	22"	X	\$2,035	\$2,145	\$2,715
24"	square	Hand crank	27.25" - 36.75"	EEX1 24SQ H	22"	X	\$1,575	\$1,685	\$2,255
30"	square	Hand crank	27.25" - 36.75"	EEX1 30SQ H	26"	X	\$1,645	\$1,775	\$2,395
30"	square	Pneumatic	27.25" - 45"	EEX1 30SQ P	26"	X	\$2,105	\$2,235	\$2,855
30"	square	Stationary		EEX1 30SQ S	22"	X	\$1,120	\$1,250	\$1,870
36"	square	Pneumatic	27.25" - 45"	EEX1 36SQ P	32"	X	\$2,210	\$2,365	\$3,020
36"	square	Stationary		EEX1 36SQ S	32"	X	\$1,200	\$1,355	\$2,010
42"	square	Stationary		EEX1 42SQ S	36"	X	\$1,400	\$1,610	\$2,270
42"	square	Pneumatic	27.25" - 45"	EEX1 42SQ P	36"	X	\$2,415	\$2,625	\$3,285
24"	square	Stationary		EEX1 24SQ S	22"	X	\$1,050	\$1,160	\$1,730

**OPTIONS:**

Locking casters for T Bases (Raises height by 2)  
Locking casters for X Bases (Raises height by 2)

CS \$40 list per base  
CS \$80 list per base



Height Adjustment Ranges:  
 Pneumatic 27.25" - 45"  
 Hand crank 27.25" - 36.75"  
 Electric 2 stage 27.75" - 46.75"  
 Electric 3 stage 22.25" - 48.25"

**AS OF 2021  
 PRODUCT UPDATE  
 See Hi5Furniture.com  
 For Offering & Pricing**

**FINISHES NEEDED:** <http://hi5furniture.com/finishes/>

HPL Top: Hi5 Graded-in laminates or Non-Premium Wilsonart or Formica  
 Edge Color: Any Hi5 standard  
 Base Finish: Black or Silver ONLY

HPL Top 3mm PVC Suffix L3	HPL Top Knife PVC Suffix L11	HPL Top Knife Wood Suffix L33	HPL Top Plywood edges Suffix L17

Table Size	Top Shape	Table Function	Model Code:	Top QTY	Base QTY	Base Spread	Base Style	Suffix L3	Suffix L11	Suffix L33	Suffix L18
24" x 48"	rectangle	Stationary	EEC1 1248RE S	1	2	18"	C	\$1,345	\$1,415		\$1,915
24" x 48"	rectangle	Stationary	EET1 2448RE S	1	2	18"	T	\$1,345	\$1,415		\$1,915
24" x 48"	rectangle	Pneumatic	EEC1 2448RE P	1	2	18"	C	\$4,325	\$4,400		\$4,895
24" x 48"	rectangle	Pneumatic	EET1 2448RE P	1	2	18"	T	\$4,325	\$4,400		\$4,895
24" x 48"	rectangle	Hand crank	EEC1 2448RE H	1	2	18"	C	\$2,375	\$2,450		\$2,945
24" x 48"	rectangle	Hand crank	EET1 2448RE H	1	2	18"	T	\$2,375	\$2,450		\$2,945
24" x 48"	rectangle	Electric 2 stage	EEC1 2448RE E2	1	2	18"	C	\$4,170	\$4,240		\$4,740
24" x 48"	rectangle	Electric 2 stage	EET1 2448RE E2	1	2	18"	T	\$4,170	\$4,240		\$4,740
24" x 48"	rectangle	Electric 3 stage	EEC1 2448RE E3	1	2	18"	C	\$4,920	\$4,990		\$5,490
24" x 48"	rectangle	Electric 3 stage	EET1 2448RE E3	1	2	18"	T	\$4,920	\$4,990		\$5,490
24" x 60"	rectangle	Stationary	EEC1 2460RE S	1	2	18"	C	\$1,430	\$1,505		\$2,150
24" x 60"	rectangle	Stationary	EET1 2460RE S	1	2	18"	T	\$1,430	\$1,505		\$2,150
24" x 60"	rectangle	Pneumatic	EEC1 2460RE P	1	2	18"	C	\$4,410	\$4,490		\$5,130
24" x 60"	rectangle	Pneumatic	EET1 2460RE P	1	2	18"	T	\$4,410	\$4,490		\$5,130
24" x 60"	rectangle	Hand crank	EEC1 2460RE H	1	2	18"	C	\$2,460	\$2,540		\$3,180
24" x 60"	rectangle	Hand crank	EET1 2460RE H	1	2	18"	T	\$2,460	\$2,540		\$3,180
24" x 60"	rectangle	Electric 2 stage	EEC1 2460RE E2	1	2	18"	C	\$4,135	\$4,330		\$4,975
24" x 60"	rectangle	Electric 2 stage	EET1 2460RE E2	1	2	18"	T	\$4,135	\$4,330		\$4,975
24" x 60"	rectangle	Electric 3 stage	EEC1 2460RE E3	1	2	18"	C	\$5,005	\$8,680		\$5,725
24" x 60"	rectangle	Electric 3 stage	EET1 2460RE E3	1	2	18"	T	\$5,005	\$8,680		\$5,725
24" x 72"	rectangle	Stationary	EEC1 2472RE S	1	2	18"	C	\$2,580	\$1,595		\$2,400
24" x 72"	rectangle	Stationary	EET1 2472RE S	1	2	18"	T	\$2,580	\$1,595		\$2,400
24" x 72"	rectangle	Pneumatic	EEC1 2472RE P	1	2	18"	C	\$4,470	\$4,580		\$5,380
24" x 72"	rectangle	Pneumatic	EET1 2472RE P	1	2	18"	T	\$4,470	\$4,580		\$5,380
24" x 72"	rectangle	Hand crank	EEC1 2472RE H	1	2	18"	C	\$2,530	\$2,630		\$3,430
24" x 72"	rectangle	Hand crank	EET1 2472RE H	1	2	18"	T	\$2,530	\$2,630		\$3,430
24" x 72"	rectangle	Electric 2 stage	EEC1 2472RE E2	1	2	18"	C	\$4,325	\$4,420		\$5,225
24" x 72"	rectangle	Electric 2 stage	EET1 2472RE E2	1	2	18"	T	\$4,325	\$4,420		\$5,225
24" x 72"	rectangle	Electric 3 stage	EEC1 2472RE E3	1	2	18"	C	\$5,075	\$5,170		\$5,975
24" x 72"	rectangle	Electric 3 stage	EET1 2472RE E3	1	2	18"	T	\$5,075	\$5,170		\$5,975

**OPTIONS:**

- Locking casters for TBases (Raises height by 2)) CS \$40 list per base
- Locking casters for XBases (Raises height by 2)) CS \$80 list per base



Height Adjustment Ranges:  
 Pneumatic 27.25" - 45"  
 Hand crank 27.25" - 36.75"  
 Electric 2 stage 27.75" - 46.75"  
 Electric 3 stage 22.25" - 48.25"

**AS OF 2021  
 PRODUCT UPDATE  
 See Hi5Furniture.com  
 For Offering & Pricing**

**FINISHES NEEDED:** <http://hi5furniture.com/finishes/>

HPL Top: Hi5 Graded-in laminates or Non-Premium Wilsonart or Formica

Edge Color: Any Hi5 standard

Base Finish: Black or Silver ONLY

HPL Top 3mm PVC Suffix L3	HPL Top Knife PVC Suffix L11	HPL Top Knife Wood Suffix L33	HPL Top Knife Plywood Suffix L18

Table Size	Top Shape	Table Function	Model Code:	QTY	Base QTY	Base Spread	Base Style	Base Price	Top Price	Total Price
30" x 48"	rectangle	Stationary	EEC1 3048RE S	1	2	22"	C	\$1,450	\$1,530	\$2,185
30" x 48"	rectangle	Stationary	EET1 3048RE S	1	2	22"	T	\$1,450	\$1,530	\$2,185
30" x 48"	rectangle	Pneumatic	EEC1 3048RE P	1	2	22"	C	\$4,430	\$4,505	\$5,160
30" x 48"	rectangle	Pneumatic	EET1 3048RE P	1	2	22"	T	\$4,430	\$4,505	\$5,160
30" x 48"	rectangle	Hand crank	EEC1 3048RE H	1	2	22"	C	\$2,480	\$2,555	\$3,210
30" x 48"	rectangle	Hand crank	EET1 3048RE H	1	2	22"	T	\$2,480	\$2,555	\$3,210
30" x 48"	rectangle	Electric 2 stage	EEC1 3048RE E2	1	2	22"	C	\$4,265	\$4,345	\$5,000
30" x 48"	rectangle	Electric 2 stage	EET1 3048RE E2	1	2	22"	T	\$4,265	\$4,345	\$5,000
30" x 48"	rectangle	Electric 3 stage	EEC1 3048RE E3	1	2	22"	C	\$5,030	\$5,105	\$5,760
30" x 48"	rectangle	Electric 3 stage	EET1 3048RE E3	1	2	22"	T	\$5,030	\$5,105	\$5,760
30" x 60"	rectangle	Stationary	EEC1 3060RE S	1	2	22"	C	\$1,550	\$1,640	\$2,485
30" x 60"	rectangle	Stationary	EET1 3060RE S	1	2	22"	T	\$1,550	\$1,640	\$2,485
30" x 60"	rectangle	Pneumatic	EEC1 3060RE P	1	2	22"	C	\$4,525	\$4,615	\$5,460
30" x 60"	rectangle	Pneumatic	EET1 3060RE P	1	2	22"	T	\$4,525	\$4,615	\$5,460
30" x 60"	rectangle	Hand crank	EEC1 3060RE H	1	2	22"	C	\$2,575	\$2,665	\$3,510
30" x 60"	rectangle	Hand crank	EET1 3060RE H	1	2	22"	T	\$2,575	\$2,665	\$3,510
30" x 60"	rectangle	Electric 2 stage	EEC1 3060RE E2	1	2	22"	C	\$4,360	\$4,450	\$5,300
30" x 60"	rectangle	Electric 2 stage	EET1 3060RE E2	1	2	22"	T	\$4,360	\$4,450	\$5,300
30" x 60"	rectangle	Electric 3 stage	EEC1 3060RE E3	1	2	22"	C	\$5,125	\$5,215	\$6,060
30" x 60"	rectangle	Electric 3 stage	EET1 3060RE E3	1	2	22"	T	\$5,125	\$5,215	\$6,060
30" x 72"	rectangle	Stationary	EEC1 3072RE S	1	2	22"	C	\$1,645	\$1,745	\$2,795
30" x 72"	rectangle	Stationary	EET1 3072RE S	1	2	22"	T	\$1,645	\$1,745	\$2,795
30" x 72"	rectangle	Pneumatic	EEC1 3072RE P	1	2	22"	C	\$4,620	\$4,720	\$5,770
30" x 72"	rectangle	Pneumatic	EET1 3072RE P	1	2	22"	T	\$4,620	\$4,720	\$5,770
30" x 72"	rectangle	Hand crank	EEC1 3072RE H	1	2	22"	C	\$2,670	\$2,770	\$3,820
30" x 72"	rectangle	Hand crank	EET1 3072RE H	1	2	22"	T	\$2,670	\$2,770	\$3,820
30" x 72"	rectangle	Electric 2 stage	EEC1 3072RE E2	1	2	22"	C	\$4,460	\$4,560	\$5,610
30" x 72"	rectangle	Electric 2 stage	EET1 3072RE E2	1	2	22"	T	\$4,460	\$4,560	\$5,610
30" x 72"	rectangle	Electric 3 stage	EEC1 3072RE E3	1	2	22"	C	\$5,220	\$5,320	\$6,370
30" x 72"	rectangle	Electric 3 stage	EET1 3072RE E3	1	2	22"	T	\$5,220	\$5,320	\$6,370

**OPTIONS:**

Locking casters for TBases (Raises height by 2))

CS \$40 list per base

Locking casters for XBases (Raises height by 2))

CS \$80 list per base



Height Adjustment Ranges:  
 Pneumatic 27.25" - 45"  
 Hand crank 27.25" - 36.75"  
 Electric 2 stage 27.75" - 46.75"  
 Electric 3 stage 22.25" - 48.25"

**AS OF 2021  
 PRODUCT UPDATE  
 See Hi5Furniture.com  
 For Offering & Pricing**

**FINISHES NEEDED:** <http://hi5furniture.com/finishes/>

HPL Top: Hi5 Graded-in laminates or Non-Premium Wilsonart or Formica

Edge Color: Any Hi5 standard

Base Finish: Black or Silver ONLY

HPL Top 3mm PVC Suffix L3	HPL Top Knife PVC Suffix L11	HPL Top Knife Wood Suffix L33	HPL Top Plywood edges Suffix L17

Table Size	Top Shape	Table Function	Model Code:	Top QTY	Base QTY	Base Spread	Base Style	Suffix L3	Suffix L11	Suffix L33	Suffix L18
36" x 48"	rectangle	Stationary	EEC1 3648RE S	1	2	26"	C	\$1,565	\$1,650		\$2,450
36" x 48"	rectangle	Stationary	EET1 3648RE S	1	2	26"	T	\$1,565	\$1,650		\$2,450
36" x 48"	rectangle	Pneumatic	EEC1 3648RE P	1	2	26"	C	\$4,550	\$4,630		\$5,430
36" x 48"	rectangle	Pneumatic	EET1 3648RE P	1	2	26"	T	\$4,550	\$4,630		\$5,430
36" x 48"	rectangle	Hand crank	EEC1 3648RE H	1	2	26"	C	\$2,590	\$2,675		\$3,475
36" x 48"	rectangle	Hand crank	EET1 3648RE H	1	2	26"	T	\$2,590	\$2,675		\$3,475
36" x 48"	rectangle	Electric 2 stage	EEC1 3648RE E2	1	2	26"	C	\$4,390	\$4,475		\$5,275
36" x 48"	rectangle	Electric 2 stage	EET1 3648RE E2	1	2	26"	T	\$4,390	\$4,475		\$5,275
36" x 48"	rectangle	Electric 3 stage	EEC1 3648RE E3	1	2	26"	C	\$5,140	\$5,225		\$6,025
36" x 48"	rectangle	Electric 3 stage	EET1 3648RE E3	1	2	26"	T	\$5,140	\$5,225		\$6,025
36" x 60"	rectangle	Stationary	EEC1 3660RE S	1	2	26"	C	\$1,680	\$1,775		\$2,800
36" x 60"	rectangle	Stationary	EET1 3660RE S	1	2	26"	T	\$1,680	\$1,775		\$2,800
36" x 60"	rectangle	Pneumatic	EEC1 3660RE P	1	2	26"	C	\$4,660	\$4,760		\$5,785
36" x 60"	rectangle	Pneumatic	EET1 3660RE P	1	2	26"	T	\$4,660	\$4,760		\$5,785
36" x 60"	rectangle	Hand crank	EEC1 3660RE H	1	2	26"	C	\$2,705	\$2,800		\$3,830
36" x 60"	rectangle	Hand crank	EET1 3660RE H	1	2	26"	T	\$2,705	\$2,800		\$3,830
36" x 60"	rectangle	Electric 2 stage	EEC1 3660RE E2	1	2	26"	C	\$4,505	\$4,600		\$5,630
36" x 60"	rectangle	Electric 2 stage	EET1 3660RE E2	1	2	26"	T	\$4,505	\$4,600		\$5,630
36" x 60"	rectangle	Electric 3 stage	EEC1 3660RE E3	1	2	26"	C	\$5,255	\$5,350		\$6,380
36" x 60"	rectangle	Electric 3 stage	EET1 3660RE E3	1	2	26"	T	\$5,255	\$5,350		\$6,380
36" x 72"	rectangle	Stationary	EEC1 3672RE S	1	2	26"	C	\$1,790	\$1,900		\$3,175
36" x 72"	rectangle	Stationary	EET1 3672RE S	1	2	26"	T	\$1,790	\$1,900		\$3,175
36" x 72"	rectangle	Pneumatic	EEC1 3672RE P	1	2	26"	C	\$4,770	\$4,885		\$6,155
36" x 72"	rectangle	Pneumatic	EET1 3672RE P	1	2	26"	T	\$4,770	\$4,885		\$6,155
36" x 72"	rectangle	Hand crank	EEC1 3672RE H	1	2	26"	C	\$2,815	\$2,930		\$4,200
36" x 72"	rectangle	Hand crank	EET1 3672RE H	1	2	26"	T	\$2,815	\$2,930		\$4,200
36" x 72"	rectangle	Electric 2 stage	EEC1 3672RE E2	1	2	26"	C	\$4,615	\$4,730		\$6,000
36" x 72"	rectangle	Electric 2 stage	EET1 3672RE E2	1	2	26"	T	\$4,615	\$4,730		\$6,000
36" x 72"	rectangle	Electric 3 stage	EEC1 3672RE E3	1	2	26"	C	\$5,365	\$5,480		\$6,750
36" x 72"	rectangle	Electric 3 stage	EET1 3672RE E3	1	2	26"	T	\$5,365	\$5,480		\$6,750

**OPTIONS:**

Locking casters for T Bases (Raises height by 2))

CS \$40 list per base

Locking casters for X Bases (Raises height by 2))

CS \$80 list per base



NOTE: Nesting tables come standard on locking casters.  
The Beam nesting system is used for 84" long and 96" long tables

**FINISHES NEEDED:** <http://hi5furniture.com/finishes/>

HPL Top: Hi5 Graded-in laminates or Non-Premium Wilsonart or Formica  
Edge Color: Any Hi5 standard  
Base Finish: Any Hi5 standard

HPL Top Self edges <b>Suffix L6</b>	HPL Top Wood edges <b>Suffix L20</b>	HPL Top Plywood edges <b>Suffix L17</b>	
HPL Top 3mm PVC <b>Suffix L3</b>	HPL Top Knife PVC <b>Suffix L11</b>	HPL Top Knife Wood <b>Suffix L33</b>	HPL Top Knife Plywood <b>Suffix L18</b>

Table Size	Top Shape	Table Function	Model Code:	Base QTY	Base Spread	Base Style			
30" x 29" H	ROUND	stationary	GYX1 3029RDS	1	26"	X	\$900	\$1,090	\$1,520
30" x 29" H	ROUND	nesting	GYX1 3029RDN	1	26"	X	\$1,235	\$1,420	\$1,910
36" x 29" H	ROUND	stationary	GYX1 3629RDS	1	32"	X	\$1,100	\$1,250	\$1,825
36" x 29" H	ROUND	nesting	GYX1 3629RDN	1	32"	X	\$1,435	\$1,585	\$2,220
42" x 29" H	ROUND	stationary	GYX1 4229RDS	1	32"	X	\$1,290	\$1,420	\$2,120
42" x 29" H	ROUND	nesting	GYX1 4229RDN	1	32"	X	\$1,620	\$1,705	\$2,510
48" x 29" H	ROUND	stationary	GYX1 4829RDS	1	38"	X	\$1,320	\$1,550	\$2,420
48" x 29" H	ROUND	folding	GYT2 4829RDF	2	36"	TT	\$3,035	\$3,170	\$4,540
48" x 29" H	ROUND	beam nesting	GYT2 4829RD BN	2	32"	TT	\$3,970	\$4,100	\$5,470
60" x 29" H	ROUND	stationary	GYX4 6029RDS	1	36"	X4	\$2,845	\$2,995	\$5,280
60" x 29" H	ROUND	stationary	GYT2 6029RDS	2	36"	TT	\$1,985	\$2,135	\$4,425
60" x 29" H	ROUND	folding	GYT2 6029RDF	2	36"	TT	\$3,215	\$3,365	\$5,650
60" x 29" H	ROUND	beam nesting	GYT2 6029RD BN	2	36"	TT	\$4,575	\$4,725	\$7,010
72" x 29" H	ROUND	beam nesting	GYT2 7229RD BN	2	36"	TT	\$6,800	\$7,000	\$9,990

POWER & A/V OPTIONS SEE PAGES 8-20

TABLE OPTIONS:

36" long Horizontal 4 track Extruded Raceway  
Laser cut holes in base - 1.5" x 2.5"

Bar Height table (overall table height is 41.5")

Café Height tables (overall table height is 36")

Adjustable height (spring clip) T-Base only

Locking Casters (T Bases - Locking Casters are standard on nesting tables)

Locking Casters (X Bases - Locking Casters are standard on nesting tables)

Polished Chrome (X Bases)

HW	\$80 per piece
WB	\$100 list per table
BH	\$130 per base
CH	\$130 per base
AH	\$280 per base
CS	\$40 per table
CS	\$80 per table
CR	\$170 per table





NOTE: Nesting tables come standard on locking casters.  
The Beam nesting system is used for 84" long and 96" long tables

**FINISHES NEEDED:** <http://hi5furniture.com/finishes/>

HPL Top: Hi5 Graded-in laminates or Non-Premium Wilsonart or Formica

Edge Color: Any Hi5 standard

Base Finish: Any Hi5 standard

Table Size	Top Shape	Table Function	Model Code:	Base QTY	Base Spread	Base Style			
30" x 29" H	SQUARE	stationary	GYX1 303029SQS	1	26"	X	\$830	\$985	\$1,410
30" x 29" H	SQUARE	nesting	GYX1 303029SQN	1	26"	X	\$1,160	\$1,320	\$1,805
36" x 29" H	SQUARE	stationary	GYX1 363629SQS	1	32"	X	\$1,015	\$1,160	\$1,710
36" x 29" H	SQUARE	nesting	GYX1 363629SQN	1	32"	X	\$1,350	\$1,495	\$2,105
42" x 29" H	SQUARE	stationary	GYX1 424229SQS	1	32"	X	\$1,075	\$1,385	\$2,085
42" x 29" H	SQUARE	nesting	GYX1 424229SQN	1	32"	X	\$1,410	\$1,720	\$2,480
48" x 29" H	SQUARE	stationary	GYX1 484829SQS	1	38"	X	\$1,160	\$1,450	\$2,340
48" x 29" H	SQUARE	folding	GYT2 484829SQF	2	36"	TT	\$2,975	\$3,065	\$4,360
48" x 29" H	SQUARE	beam nesting	GYT2 484829SQBN	2	32"	TT	\$3,910	\$4,000	\$5,295
60" x 29" H	SQUARE	stationary	GYX4 606029SQS	1	36"	X4	\$2,770	\$2,890	\$5,060
60" x 29" H	SQUARE	stationary	GYT2 606029SQS	2	36"	TT	\$1,910	\$2,035	\$4,620
60" x 29" H	SQUARE	folding	GYT2 606029SQF	2	36"	TT	\$3,205	\$3,330	\$5,495
72" x 29" H	SQUARE	beam nesting	GYT2 7229SQ BN	2	36"	TT	\$6,800	\$7,000	\$9,990

POWER & A/V OPTIONS SEE PAGES 8-20

TABLE OPTIONS:

36" long Horizontal 4 track Extruded Raceway

Laser cut holes in base - 1.5" x 2.5"

Bar Height table (overall table height is 41.5")

Café Height tables (overall table height is 36")

Adjustable height (spring clip) T-Base only

Locking Casters (T Bases - Locking Casters are standard on nesting tables)

Locking Casters (X Bases - Locking Casters are standard on nesting tables)

Polished Chrome (X Bases)

HW	\$80 per piece
WB	\$100 list per table
BH	\$130 per base
CH	\$130 per base
AH	\$280 per base
CS	\$40 per table
CS	\$80 per table
CR	\$170 per table



TRAPEZOID



HALF ROUND



CRESCENT

NOTE: Nesting tables come standard on locking casters.

**FINISHES NEEDED:** <http://hi5furniture.com/finishes/>

HPL Top: Hi5 Graded-in laminates or Non-Premium Wilsonart or Formica

Edge Color: Any Hi5 standard

Base Finish: Any Hi5 standard



Table Size	Top Shape	Table Function	Model Code:	Base QTY	Base Spread	Base Style	
24 x 60x 29"H	trapezoid	stationary	GYTI 246029TZS	2	16"	T	\$930
24 x 60x 29" H	trapezoid	nesting	GYTI 246029TZN	2	16"	T	\$1,490
24 x 72x 29" H	trapezoid	stationary	GYTI 247229TZS	2	16"	T	\$1,100
24 x 72x 29" H	trapezoid	nesting	GYTI 247229TZN	2	16"	T	\$1,650
30 x 60x 29" H	trapezoid	stationary	GYTI 306029TZS	2	22"	T	\$1,055
30 x 60x 29" H	trapezoid	nesting	GYTI 306029TZN	2	22"	T	\$1,610
30 x 72x 29" H	trapezoid	stationary	GYTI 307229TZS	2	22"	T	\$1,245
30 x 72x 29" H	trapezoid	nesting	GYTI 307229TZN	2	22"	T	\$1,795
24 x 48x 29" H	half round	stationary	GYTI 244829HRS	2	16"	T	\$895
24 x 48x 29" H	half round	nesting	GYTI 244829HRN	2	16"	T	\$1,445
30 x 60x 29" H	half round	stationary	GYTI 306029HRS	2	22"	T	\$1,040
30 x 60x 29" H	half round	nesting	GYTI 306029HRN	2	22"	T	\$1,590
36 x 72x 29" H	half round	stationary	GYTI 367229HRS	2	26"	T	\$1,245
36 x 72x 29" H	half round	nesting	GYTI 367229HRN	2	26"	T	\$1,795
24 x 48 x 29" H	crescent	stationary	GYTI 244829CRS	2	22"	T	\$1,350
24 x 48x 29" H	crescent	nesting	GYTI 244829CRN	2	22"	T	\$1,900
30 x 60x 29" H	crescent	stationary	GYTI 306029CRS	2	26"	T	\$1,750
30 x 60x 29" H	crescent	nesting	GYTI 306029CRN	2	26"	T	\$2,300
36 x 72x 29" H	crescent	stationary	GYTI 367229CRS	2	26"	T	\$2,040

POWER & A/V OPTIONS SEE PAGES 8-20

TABLE OPTIONS:

- 36" long Horizontal 4 track Extruded Raceway
- Vertical ABS Leg Way for table base (black or silver)
- Laser cut holes in base - 1.5" x 2.5"
- Bar Height table (overall table height is 41.5")
- Café Height tables (overall table height is 36")
- Polished Chrome (T Bases)

- HW \$80 per piece
- WV (B/S) \$25 per piece
- WB \$100 list per table
- BH \$130 per base
- CH \$130 per base
- CRT \$160 per base



NOTE: Nesting tables come standard on locking casters.  
The Beam nesting system is used for 84" long and 96" long tables

**FINISHES NEEDED:** <http://hi5furniture.com/finishes/>

HPL Top: Hi5 Graded-in laminates or Non-Premium Wilsonart or Formica  
Edge Color: Any Hi5 standard  
Base Finish: Any Hi5 standard

HPL Top Self edges <b>Suffix L6</b>	HPL Top Wood edges <b>Suffix L20</b>	HPL Top Plywood edges <b>Suffix L17</b>	
HPL Top 3mm PVC <b>Suffix L3</b>	HPL Top Knife PVC <b>Suffix L11</b>	HPL Top Knife Wood <b>Suffix L33</b>	HPL Top Knife Plywood <b>Suffix L18</b>

Table Size	Top Shape	Table Function	Model Code:	Base QTY	Base Spread	Base Style			
18 x 48x 29"H	rectangle	stationary	GYTI 184829RES	2	16"	T	\$860	\$980	\$1,400
18 x 48x 29"H	rectangle	folding	GYTI 184829REF	2	16"	T	\$1,465	\$1,535	\$2,065
18 x 48x 29"H	rectangle	nesting	GYTI 184829REN	2	16"	T	\$1,415	\$1,530	\$2,045
18 x 60x 29"H	rectangle	stationary	GYTI 186029RES	2	16"	T	\$920	\$1,045	\$1,530
18 x 60x 29"H	rectangle	folding	GYTI 186029REF	2	16"	T	\$1,295	\$1,420	\$1,965
18 x 60x 29"H	rectangle	nesting	GYTI 186029REN	2	16"	T	\$1,475	\$1,595	\$2,185
18 x 72x 29"H	rectangle	stationary	GYTI 187229RES	2	16"	T	\$970	\$1,115	\$1,665
18 x 72x 29"H	rectangle	folding	GYTI 187229REF	2	16"	T	\$1,345	\$1,490	\$2,105
18 x 72x 29"H	rectangle	nesting	GYTI 187229REN	2	16"	T	\$1,520	\$1,665	\$2,315
18 x 84x 29"H	rectangle	stationary	GYTI 188429RES	2	16"	T	\$1,065	\$1,180	\$1,795
18 x 84x 29"H	rectangle	folding	GYTI 188429REF	2	16"	T	\$1,440	\$1,555	\$2,240
18 x 96x 29"H	rectangle	stationary	GYTI 189629RES	2	16"	T	\$1,085	\$1,245	\$2,085
18 x 96x 29"H	rectangle	folding	GYTI 189629REF	2	16"	T	\$1,450	\$1,620	\$2,530

POWER & A/V OPTIONS SEE PAGES 8-20

TABLE OPTIONS:

Table Gangers (per set) (N/A on wood edge tops)	TG	\$135 per set
36" long Horizontal 4 track Extruded Raceway	HW	\$80 per piece
Vertical ABS Leg Way for table base (black or silver)	WV (B/S)	\$25 per piece
Laser cut holes in base - 1.5" x 2.5"	WB	\$100 list per table
Bar Height table (overall table height is 41.5")	BH	\$130 per base
Café Height tables (overall table height is 36")	CH	\$130 per base
Adjustable height (spring clip) T-Base only	AH	\$280 per base
Locking Casters (T Bases)	CS	\$80 per table
Polished Chrome (T Bases)	CRT	\$160 per base

MODESTY PANELS: 9" High panels

30" panel perforated metal	MM30	\$185 list price
36" panel perforated metal	MM36	\$190 list price
42" panel perforated metal	MM42	\$225 list price
48" panel perforated metal	MM48	\$230 list price
60" panel perforated metal	MM60	\$245 list price
72" panel perforated metal	MM72	\$265 list price



NOTE: Nesting tables come standard on locking casters.  
The Beam nesting system is used for 84" long and 96" long tables

**FINISHES NEEDED:** <http://hi5furniture.com/finishes/>

HPL Top: Hi5 Graded-in laminates or Non-Premium Wilsonart or Formica

Edge Color: Any Hi5 standard

Base Finish: Any Hi5 standard

Table Size	Top Shape	Table Function	Model Code:	Base QTY	Base Spread	Base Style			
24 x 48x 29"H	rectangle	stationary	GYTI 244829RES	2	22"	T	\$985	\$1,185	\$1,730
24 x 48x 29"H	rectangle	nesting	GYTI 244829REN	2	22"	T	\$1,590	\$1,785	\$2,450
24 x 60x 29"H	rectangle	stationary	GYTI 246029RES	2	22"	T	\$1,035	\$1,265	\$1,925
24 x 60x 29"H	rectangle	folding	GYTI 246029REF	2	22"	T	\$1,430	\$1,665	\$2,395
24 x 60x 29"H	rectangle	nesting	GYTI 246029REN	2	22"	T	\$1,640	\$1,880	\$2,645
24 x 72x 29"H	rectangle	stationary	GYTI 247229RES	2	22"	T	\$1,090	\$1,365	\$2,110
24 x 72x 29"H	rectangle	folding	GYTI 247229REF	2	22"	T	\$1,480	\$1,760	\$2,575
24 x 72x 29"H	rectangle	nesting	GYTI 247229REN	2	22"	T	\$1,695	\$1,970	\$2,825
24 x 84x 29"H	rectangle	stationary	GYTI 248429RES	2	22"	T	\$1,190	\$1,450	\$2,300
24 x 84x 29"H	rectangle	folding	GYTI 248429REF	2	22"	T	\$1,590	\$1,845	\$2,765
24 x 84x 29"H	rectangle	beam nesting	GYTI 2484RE BN	2	22"	T	\$2,765	\$2,860	\$4,095
24 x 96x 29"H	rectangle	stationary	GYTI 249629RES	2	22"	T	\$1,215	\$1,550	\$2,485
24 x 96x 29"H	rectangle	folding	GYTI 249629REF	2	22"	T	\$1,610	\$1,950	\$2,950
24 x 96x 29"H	rectangle	beam nesting	GYTI 2496RE BN	2	22"	T	\$2,770	\$2,885	\$4,110

POWER & A/V OPTIONS SEE PAGES 8-20

TABLE OPTIONS:

Table Gangers (per set) (N/A on wood edge tops)	TG	\$135 per set
36" long Horizontal 4 track Extruded Raceway	HW	\$80 per piece
Vertical ABS Legway for table base (black or silver)	WV (B/S)	\$25 per piece
Laser cut holes in base - 1.5" x 2.5"	WB	\$100 list per table
Bar Height table (overall table height is 41.5")	BH	\$130 per base
Café Height tables (overall table height is 36")	CH	\$130 per base
Adjustable height (spring clip) T-Base only	AH	\$280 per base
Locking Casters (T Bases)	CS	\$80 per table
Polished Chrome (T Bases)	CRT	\$160 per base

MODESTY PANELS: 9" High panels

30" panel perforated metal	MM30	\$185 list price
36" panel perforated metal	MM36	\$190 list price
42" panel perforated metal	MM42	\$225 list price
48" panel perforated metal	MM48	\$230 list price
60" panel perforated metal	MM60	\$245 list price
72" panel perforated metal	MM72	\$265 list price



NOTE: Nesting tables come standard on locking casters.  
The Beam nesting system is used for 84" long and 96" long tables

**FINISHES NEEDED:** <http://hi5furniture.com/finishes/>

HPL Top: Hi5 Graded-in laminates or Non-Premium Wilsonart or Formica

Edge Color: Any Hi5 standard

Base Finish: Any Hi5 standard

HPL Top Self edges <b>Suffix L6</b>	HPL Top Wood edges <b>Suffix L20</b>	HPL Top Plywood edges <b>Suffix L17</b>	
HPL Top 3mm PVC <b>Suffix L3</b>	HPL Top Knife PVC <b>Suffix L11</b>	HPL Top Knife Wood <b>Suffix L33</b>	HPL Top Knife Plywood <b>Suffix L18</b>

Table Size	Top Shape	Table Function	Model Code:	Base QTY	Base Spread	Base Style			
30 x 48x 29"H	rectangle	stationary	GYTI 304829RES	2	26"	T	\$1,040	\$1,285	\$1,925
30 x 48x 29"H	rectangle	stationary	GYTI 304829REF	2	26"	T	\$1,585	\$1,665	\$2,325
30 x 48x 29"H	rectangle	nesting	GYTI 304829REN	2	26"	T	\$1,650	\$1,890	\$2,645
30 x 60x 29"H	rectangle	stationary	GYTI 306029RES	2	26"	T	\$1,100	\$1,385	\$2,160
30 x 60x 29"H	any shape	stationary	GYTI 306029??S	2	26"	T	\$1,250	\$1,350	\$2,055
30 x 60x 29"H	rectangle	folding	GYTI 306029REF	2	26"	T	\$1,495	\$1,780	\$2,620
30 x 60x 29"H	rectangle	nesting	GYTI 306029REN	2	26"	T	\$1,705	\$1,990	\$2,875
30 x 72x 29"H	rectangle	stationary	GYTI 307229RES	2	26"	T	\$1,160	\$1,505	\$2,395
30 x 72x 29"H	any shape	stationary	GYTI 307229??S	2	26"	T	\$1,305	\$1,445	\$2,270
30 x 72x 29"H	rectangle	folding	GYTI 307229REF	2	26"	T	\$1,555	\$1,900	\$2,855
30 x 72x 29"H	rectangle	nesting	GYTI 307229REN	2	26"	T	\$1,765	\$2,110	\$3,110
30 x 84x 29"H	rectangle	stationary	GYTI 308429RES	2	26"	T	\$1,295	\$1,615	\$2,615
30 x 84x 29"H	any shape	stationary	GYTI 308429??S	2	26"	T	\$1,430	\$1,550	\$2,480
30 x 84x 29"H	rectangle	folding	GYTI 308429REF	2	26"	T	\$1,690	\$2,015	\$3,085
30 x 84x 29"H	rectangle	beam nesting	GYTI 308429REBN	2	26"	T	\$2,880	\$2,990	\$4,590
30 x 96x 29"H	rectangle	stationary	GYTI 309629RES	2	26"	T	\$1,305	\$1,725	\$2,850
30 x 96x 29"H	any shape	stationary	GYTI 309629??S	2	26"	T	\$1,440	\$1,645	\$2,690
30 x 96x 29"H	rectangle	folding	GYTI 309629REF	2	26"	T	\$1,700	\$2,120	\$3,315
30 x 96x 29"H	rectangle	beam nesting	GYTI 309629REBN	2	26"	T	\$2,890	\$3,015	\$4,615

POWER & A/V OPTIONS SEE PAGES 8-20

TABLE OPTIONS:

- Table Gangers (per set) (N/A on wood edge tops)
- 36" long Horizontal 4 track Extruded Raceway
- Vertical ABS Leg Way for table base (black or silver)
- Laser cut holes in base - 1.5" x 2.5"
- Bar Height table (overall table height is 41.5")
- Café Height tables (overall table height is 36")
- Adjustable height (spring clip) T-Base only
- Locking Casters (T Bases)
- Polished Chrome (T Bases)

TG	\$135 per set
HW	\$80 per piece
WV (B/S)	\$25 per piece
WB	\$100 list per table
BH	\$130 per base
CH	\$130 per base
AH	\$280 per base
CS	\$80 per table
CRT	\$160 per base



NOTE: Nesting tables come standard on locking casters.  
The Beam nesting system is used for 84" long and 96" long tables

**FINISHES NEEDED:** <http://hi5furniture.com/finishes/>

HPL Top: Hi5 Graded-in laminates or Non-Premium Wilsonart or Formica  
Edge Color: Any Hi5 standard  
Base Finish: Any Hi5 standard

<b>Suffix L6</b>	<b>Suffix L20</b>	<b>Suffix L17</b>	
<b>Suffix L3</b>	<b>Suffix L11</b>	<b>Suffix L33</b>	<b>Suffix L18</b>

Table Size	Top Shape	Table Function	Model Code:	Base QTY	Base Spread	Base Style			
36 x 48x 29"H	rectangle	stationary	GYT1 364829RES	2	26"	T	\$1,075	\$1,240	\$1,910
36 x 48x 29"H	rectangle	folding	GYT1 364829REF	2	26"	T	\$1,675	\$1,760	\$2,565
36 x 48x 29"H	rectangle	nesting	GYT1 364829REN	2	26"	T	\$1,780	\$1,865	\$2,670
36 x 60x 29"H	rectangle	stationary	GYT1 366029RES	2	26"	T	\$1,155	\$1,360	\$2,160
36 x 60x 29"H	any shape	stationary	GYT1 366029??S	2	26"	T	\$1,420	\$1,450	\$2,275
36 x 60x 29"H	rectangle	folding	GYT1 366029REF	2	26"	T	\$1,680	\$1,780	\$2,815
36 x 60x 29"H	rectangle	nesting	GYT1 366029REN	2	26"	T	\$2,575	\$2,675	\$3,710
36 x 72x 29"H	rectangle	stationary	GYT1 367229RES	2	26"	T	\$1,235	\$1,480	\$2,410
36 x 72x 29"H	any shape	stationary	GYT1 367229??S	2	26"	T	\$1,500	\$1,575	\$2,515
36 x 72x 29"H	rectangle	folding	GYT1 367229REF	2	26"	T	\$1,790	\$1,905	\$3,190
36 x 72x 29"H	rectangle	nesting	GYT1 367229REN	2	26"	T	\$2,685	\$2,800	\$4,085
36 x 84x 29"H	rectangle	stationary	GYT2 368429RES	2	36"	TT	\$1,855	\$2,035	\$3,170
36 x 84x 29"H	any shape	stationary	GYT2 368429??S	2	36"	TT	\$2,125	\$2,130	\$3,290
36 x 84x 29"H	rectangle	beam nesting	GYT2 3684RE BN	2	32"	TT	\$4,330	\$4,485	\$6,175
36 x 96x 29"H	rectangle	stationary	GYT2 369629RES	2	36"	TT	\$1,875	\$2,155	\$3,425
36 x 96x 29"H	any shape	stationary	GYT2 369629??S	2	36"	TT	\$2,140	\$2,250	\$3,535
36 x 96x 29"H	rectangle	beam nesting	GYT2 369629RE BN	2	32"	TT	\$4,345	\$4,500	\$6,205

POWER & A/V OPTIONS SEE PAGES 8-20

TABLE OPTIONS:

- Table Gangers (per set) (N/A on wood edge tops)
- 36" long Horizontal 4 track Extruded Raceway
- Vertical ABS Leg Way for table base (black or silver)
- Laser cut holes in base - 1.5" x 2.5"
- Bar Height table (overall table height is 41.5")
- Café Height tables (overall table height is 36")
- Adjustable height (spring clip) T-Base only
- Locking Casters (T Bases)
- Polished Chrome (T Bases)
- Polished Chrome (TT Bases)

- TG \$135 per set
- HW \$80 per piece
- WV (B/S) \$25 per piece
- WB \$100 list per table
- BH \$130 per base
- CH \$130 per base
- AH \$280 per base
- CS \$80 per table
- CRT \$160 per base
- CRTT \$225 per base



NOTE: Nesting tables come standard on locking casters.  
The Beam nesting system is used for 84" long and 96" long tables

**FINISHES NEEDED:** <http://hi5furniture.com/finishes/>

HPL Top: Hi5 Graded-in laminates or Non-Premium Wilsonart or Formica  
Edge Color: Any Hi5 standard  
Base Finish: Any Hi5 standard

HPL Top Self edges <b>Suffix L6</b>	HPL Top Wood edges <b>Suffix L20</b>	HPL Top Plywood edges <b>Suffix L17</b>	
HPL Top 3mm PVC <b>Suffix L3</b>	HPL Top Knife PVC <b>Suffix L11</b>	HPL Top Knife Wood <b>Suffix L33</b>	HPL Top Knife Plywood <b>Suffix L18</b>

Table Size	Top Shape	Table Function	Model Code:	Base QTY	Base Spread	Base Style			
48 x 60x 29"H	rectangle	stationary	GYT2 486029RES	2	36"	TT	\$1,610	\$1,985	\$3,080
48 x 60x 29"H	any shape	stationary	GYT2 486029??S	2	36"	TT	\$1,875	\$2,085	\$3,190
48 x 72x 29"H	any shape	stationary	GYT2 487229??S	2	36"	TT	\$1,955	\$2,240	\$3,520
48 x 72x 29"H	rectangle	stationary	GYT2 487229RES	2	36"	TT	\$1,690	\$2,140	\$3,400
48 x 84x 29"H	rectangle	stationary	GYT2 488429RES	2	36"	TT	\$1,875	\$3,160	\$4,745
48 x 84x 29"H	any shape	stationary	GYT2 488429??S	2	36"	TT	\$2,140	\$3,255	\$4,865
48 x 96x 29"H	rectangle	stationary	GYT2 489629RES	2	36"	TT	\$1,890	\$3,310	\$5,070
48 x 96x 29"H	any shape	stationary	GYT2 489629??S	2	36"	TT	\$2,155	\$3,410	\$5,185
48 x 120x 29"H	rectangle	stationary	GYT2 4812029RES	3	36"	TT	\$2,575	\$4,145	\$6,335
48 x 120x 29"H	any shape	stationary	GYT2 4812029??S	3	36"	TT	\$2,845	\$4,235	\$6,445
48 x 144x 29"H	rectangle	stationary	GYT2 4814429RES	4	36"	TT	\$3,650	\$5,095	\$7,745
48 x 144x 29"H	any shape	stationary	GYT2 4814429??S	4	36"	TT	\$4,630	\$5,190	\$7,860
48 x 168x 29"H	rectangle	stationary	GYT2 4816829RES	4	36"	TT	\$3,670	\$5,600	\$8,875
48 x 168x 29"H	any shape	stationary	GYT2 4816829??S	4	36"	TT	\$3,940	\$5,685	\$8,960
48 x 192x 29"H	rectangle	stationary	GYT2 4819229RES	4	36"	TT	\$3,695	\$5,710	\$9,040
48 x 192x 29"H	any shape	stationary	GYT2 4819229??S	4	36"	TT	\$3,965	\$5,810	\$9,150

POWER & A/V OPTIONS SEE PAGES 8-20

TABLE OPTIONS:

- 36" long Horizontal 4 track Extruded Raceway
- Vertical ABS Leg Way for table base (black or silver)
- Laser cut holes in base - 1.5" x 2.5"
- Bar Height table (overall table height is 41.5")
- Café Height tables (overall table height is 36")
- Polished Chrome (TT Bases)

- HW \$80 per piece
- WV (B/S) \$25 per piece
- WB \$100 list per table
- BH \$130 per base
- CH \$130 per base
- CRTT \$225 per base



NOTE: Nesting tables come standard on locking casters.  
The Beam nesting system is used for 84" long and 96" long tables

**FINISHES NEEDED:** <http://hi5furniture.com/finishes/>

HPL Top: Hi5 Graded-in laminates or Non-Premium Wilsonart or Formica

Edge Color: Any Hi5 standard

Base Finish: Any Hi5 standard

Table Size	Top Shape	Table Function	Model Code:	Base QTY	Base Spread	Base Style			
60 x 72x 29"H	rectangle	stationary	GYT2 607229RES	2	36"	TT	\$1,790	\$3,360	\$5,050
60 x 72x 29"H	any shape	stationary	GYT2 607229??S	2	36"	TT	\$2,055	\$3,450	\$4,490
60 x 84x 29"H	rectangle	stationary	GYT2 608429RES	2	36"	TT	\$2,020	\$3,420	\$5,295
60 x 84x 29"H	any shape	stationary	GYT2 608429??S	2	36"	TT	\$2,285	\$3,515	\$5,415
60 x 96x 29"H	rectangle	stationary	GYT2 609629RES	2	36"	TT	\$2,035	\$3,610	\$5,700
60 x 96x 29"H	any shape	stationary	GYT2 609629??S	2	36"	TT	\$2,300	\$3,705	\$5,810
60 x 120x 29"H	rectangle	stationary	GYT2 6012029RES	3	36"	TT	\$2,740	\$4,505	\$7,115
60 x 120x 29"H	any shape	stationary	GYT2 6012029??S	3	36"	TT	\$3,005	\$4,605	\$7,095
60 x 144x 29"H	rectangle	stationary	GYT2 6014429RES	4	36"	TT	\$3,915	\$5,535	\$8,670
60 x 144x 29"H	any shape	stationary	GYT2 6014429??S	4	36"	TT	\$4,180	\$5,625	\$8,790
60 x 168x 29"H	rectangle	stationary	GYT2 6016829RES	4	36"	TT	\$3,950	\$6,070	\$10,145
60 x 168x 29"H	any shape	stationary	GYT2 6016829??S	4	36"	TT	\$4,215	\$6,230	\$10,160
60 x 192x 29"H	rectangle	stationary	GYT2 6019229RES	4	36"	TT	\$3,950	\$6,285	\$10,265
60 x 192x 29"H	any shape	stationary	GYT2 6019229??S	4	36"	TT	\$4,230	\$6,385	\$10,380

POWER & A/V OPTIONS SEE PAGES 8-20

TABLE OPTIONS:

- 36" long Horizontal 4 track Extruded Raceway
- Vertical ABS Leg Way for table base (black or silver)
- Laser cut holes in base - 1.5" x 2.5"
- Bar Height table (overall table height is 41.5")
- Café Height tables (overall table height is 36")
- Polished Chrome (TT Bases)

- HW \$80 per piece
- WV (B/S) \$25 per piece
- WB \$100 list per table
- BH \$130 per base
- CH \$130 per base
- CRTT \$225 per base





NOTE: Nesting tables come standard on locking casters.  
The Beam nesting system is used for 84" long and 96" long tables

**FINISHES NEEDED:** <http://hi5furniture.com/finishes/>  
HPL Top: Hi5 Graded-in laminates or Non-Premium W A or Formica  
Edge Color: Any Hi5 standard  
Base Finish: Any Hi5 standard







 HPL Top 3mm PVC <b>Suffix L3</b>	 HPL Top Knife PVC <b>Suffix L11</b>	 HPL Top Knife Wood <b>Suffix L33</b>	 HPL Top Knife Plywood <b>Suffix L18</b>
 HPL Top Self edges <b>Suffix L6</b>	 HPL Top Wood edges <b>Suffix L20</b>	 HPL Top Plywood edges <b>Suffix L17</b>	

Table Size	Top Shape	Table Function	Model Code:	Base Placement	List Price	List Price	List Price	Base QTY	Base Size	Base Style
30"	round	stationary	HRX1 30RD S	Inset	\$1,400	\$1,655	\$2,260	1	26"	X
30"	round	nesting	HRX1 30RD N	Inset	\$1,640	\$1,895	\$2,500	1	26"	X
36"	round	stationary	HRX1 36RD S	Inset	\$1,470	\$1,760	\$2,390	1	26"	X
36"	round	nesting	HRX1 36RD N	Inset	\$1,710	\$2,000	\$2,630	1	26"	X
42"	round	stationary	HRX1 42RD S	Inset	\$1,780	\$2,145	\$2,780	1	36"	X
42"	round	nesting	HRX1 42RD N	Inset	\$2,020	\$2,385	\$3,020	1	36"	X
48"	round	stationary	HRX1 48RD S	Inset	\$1,790	\$2,160	\$2,840	1	36"	X
48"	round	nesting	HRX1 48RD N	Inset	\$2,030	\$2,400	\$3,080	1	36"	X
30"	square	stationary	HRX1 30SQ S	Inset	\$1,320	\$1,450	\$2,070	1	26"	X
30"	square	nesting	HRX1 30SQ N	Inset	\$1,560	\$1,690	\$2,310	1	26"	X
36"	square	stationary	HRX1 36SQ S	Inset	\$1,400	\$1,555	\$2,210	1	26"	X
36"	square	nesting	HRX1 36SQ N	Inset	\$1,640	\$1,795	\$2,450	1	26"	X
42"	square	stationary	HRX1 42SQ S	Inset	\$1,740	\$1,950	\$2,610	1	36"	X
42"	square	nesting	HRX1 42SQ N	Inset	\$1,980	\$2,190	\$2,850	1	36"	X
48"	square	stationary	HRX1 48SQ S	Inset	\$1,750	\$1,960	\$2,700	1	36"	X
48"	square	nesting	HRX1 48SQ N	Inset	\$1,990	\$2,200	\$2,940	1	36"	X

POWER & A/V OPTIONS SEE PAGES 8-20

TABLE OPTIONS:

Hidden Wheels	WL	\$50 list per base
Locking Casters	CS	\$20 list per base
Bar Height, stationary tables only.	BH	\$120 list per base
Cafe' Height, stationary tables only.	CH	\$120 list per base
Polished Aluminum	CR	\$110 list per base
Laser cut holes in base - 1.5" x 2.5"	WB	\$55 list per table



NOTE: Nesting tables come standard on locking casters.  
The Beam nesting system is used for 84" long and 96" long tables

**FINISHES NEEDED:** <http://hi5furniture.com/finishes/>  
HPL Top: Hi5 Graded-in laminates or Non-Premium W A or Formica  
Edge Color: Any Hi5 standard  
Base Finish: Any Hi5 standard



Table Size	Top Shape	Table Function	Model Code:	Base Placement	List Price	Base QTY	Base Size	Base Style
24 x 48	half round	stationary	HRT1 2448HR S	Inset	\$1,490	2	20"	T
24 x 48	half round	nesting	HRT1 2448HR N	Inset	\$2,050	2	20"	T
30 x 60	half round	stationary	HRT1 3060HR S	Inset	\$1,610	2	26"	T
30 x 60	half round	nesting	HRT1 3060HR N	Inset	\$2,210	2	26"	T
36 x 72	half round	stationary	HRT1 3672HR S	Inset	\$1,860	2	26"	T
36 x 72	half round	nesting	HRT1 3672HR N	Inset	\$2,420	2	26"	T
24 x 60	trapezoid	stationary	HRT1 2460TZ S	Inset	\$1,500	2	20"	T
24 x 60	trapezoid	nesting	HRT1 2460TZ N	Inset	\$2,060	2	20"	T
24 x 72	trapezoid	stationary	HRT1 2472TZ S	Inset	\$1,550	2	20"	T
24 x 72	trapezoid	nesting	HRT1 2472TZ N	Inset	\$2,110	2	20"	T
30 x 60	trapezoid	stationary	HRT1 3060TZ S	Inset	\$1,590	2	26"	T
30 x 60	trapezoid	nesting	HRT1 3060TZ N	Inset	\$2,150	2	26"	T
30 x 72	trapezoid	stationary	HRT1 3072TZ S	Inset	\$1,660	2	26"	T
30 x 72	trapezoid	nesting	HRT1 3072TZ N	Inset	\$2,220	2	26"	T
24 x 48	crescent	stationary	HRT1 2448CR S	Inset	\$1,690	2	20"	T
24 x 48	crescent	nesting	HRT1 2448CR N	Inset	\$2,250	2	20"	T
30 x 60	crescent	stationary	HRT1 3060CR S	Inset	\$2,130	2	26"	T
30 x 60	crescent	nesting	HRT1 3060CR N	Inset	\$2,690	2	26"	T

POWER & A/V OPTIONS SEE PAGES 8-20

TABLE OPTIONS:

Hidden Wheels	WL	\$50 list per base
Locking Casters	CS	\$20 list per base
Bar Height, stationary tables only.	BH	\$120 list per base
Cafe' Height, stationary tables only.	CH	\$120 list per base
Polished Aluminum	CR	\$110 list per base
Laser cut holes in base - 1.5" x 2.5"	WB	\$55 list per table



NOTE: Nesting tables come standard on locking casters.  
The Beam nesting system is used for 84" long and 96" long tables

**FINISHES NEEDED:** <http://hi5furniture.com/finishes/>  
HPL Top: Hi5 Graded-in laminates or Non-Premium W A or Formica  
Edge Color: Any Hi5 standard  
Base Finish: Any Hi5 standard

HPL Top Self edges <b>Suffix L6</b>	HPL Top Wood edges <b>Suffix L20</b>	HPL Top Plywood edges <b>Suffix L17</b>	
HPL Top 3mm PVC <b>Suffix L3</b>	HPL Top Knife PVC <b>Suffix L11</b>	HPL Top Knife Wood <b>Suffix L33</b>	HPL Top Knife Plywood <b>Suffix L18</b>

Table Size	Top Shape	Table Function	Model Code:	Base Placement	List Price	List Price	List Price	Base QTY	Base Size	Base Style
18 x 42	any shape	stationary	HRT1 184229	??S Edge	\$1,400	\$1,545	\$2,220	2	17"	T
18 x 42	any shape	nesting	HRT1 184229	??N Edge	\$1,965	\$2,110	\$2,785	2	17"	T
18 x 42	rectangle	stationary	HRT1 184229	RES Edge	\$1,360	\$1,495	\$2,100	2	17"	T
18 x 42	rectangle	nesting	HRT1 184229	REN Edge	\$1,925	\$2,060	\$2,665	2	17"	T
18 x 48	any shape	folding	HRT1 184829	??F Non-Stack	\$1,975	\$2,120	\$2,850	2	17"	T
18 x 48	any shape	stationary	HRT1 184829	??S Edge	\$1,400	\$1,545	\$2,275	2	17"	T
18 x 48	any shape	nesting	HRT1 184829	??N Edge	\$1,965	\$2,110	\$2,840	2	17"	T
18 x 48	rectangle	folding	HRT1 184829	REF Non-Stack	\$1,935	\$2,070	\$2,725	2	17"	T
18 x 48	rectangle	stationary	HRT1 184829	RES Edge	\$1,360	\$1,495	\$2,150	2	17"	T
18 x 48	rectangle	nesting	HRT1 184829	REN Edge	\$1,925	\$2,060	\$2,715	2	17"	T
18 x 60	any shape	folding	HRT1 186029	??F Non-Stack	\$2,025	\$2,185	\$2,805	2	17"	T
18 x 60	any shape	nesting	HRT1 186029	??N Edge	\$2,015	\$2,175	\$2,795	2	17"	T
18 x 60	any shape	stationary	HRT1 186029	??S Edge	\$1,450	\$1,610	\$2,230	2	17"	T
18 x 60	rectangle	folding	HRT1 186029	REF Non-Stack	\$1,985	\$2,135	\$2,685	2	17"	T
18 x 60	rectangle	nesting	HRT1 186029	REN Edge	\$1,975	\$2,125	\$2,675	2	17"	T
18 x 60	rectangle	stationary	HRT1 186029	RES Edge	\$1,410	\$1,560	\$2,110	2	17"	T
18 x 66	any shape	folding	HRT1 186629	??F Edge	\$1,940	\$2,120	\$2,930	2	17"	T
18 x 66	any shape	nesting	HRT1 186629	??N Edge	\$2,070	\$2,250	\$3,060	2	17"	T
18 x 66	any shape	stationary	HRT1 186629	??S Edge	\$1,505	\$1,685	\$2,495	2	17"	T
18 x 66	rectangle	folding	HRT1 186629	REF Edge	\$1,895	\$2,060	\$2,785	2	17"	T
18 x 66	rectangle	nesting	HRT1 186629	REN Edge	\$2,025	\$2,190	\$2,915	2	17"	T
18 x 66	rectangle	stationary	HRT1 186629	RES Edge	\$1,460	\$1,625	\$2,350	2	17"	T

POWER & A/V OPTIONS SEE PAGES 8-20

TABLE OPTIONS:

Hidden Wheels	WL	\$50 list per base
Locking Casters	CS	\$20 list per base
Bar Height, stationary tables only.	BH	\$120 list per base
Cafe' Height, stationary tables only.	CH	\$120 list per base
Polished Aluminum	CR	\$110 list per base
Laser cut holes in base - 1.5" x 2.5"	WB	\$55 list per table



NOTE: Nesting tables come standard on locking casters.  
The Beam nesting system is used for 84" long and 96" long tables

**FINISHES NEEDED:** <http://hi5furniture.com/finishes/>  
HPL Top: Hi5 Graded-in laminates or Non-Premium W A or Formica  
Edge Color: Any Hi5 standard  
Base Finish: Any Hi5 standard

HPL Top Self edges <b>Suffix L6</b>	HPL Top Wood edges <b>Suffix L20</b>	HPL Top Plywood edges <b>Suffix L17</b>	
HPL Top 3mm PVC <b>Suffix L3</b>	HPL Top Knife PVC <b>Suffix L11</b>	HPL Top Knife Wood <b>Suffix L33</b>	HPL Top Knife Plywood <b>Suffix L18</b>

Table Size	Top Shape	Table Function	Model Code:	Base Placement	List Price	List Price	List Price	Base QTY	Base Size	Base Style
18 x 72	any shape	folding	HRT1 187229	??F Edge	\$2,040	\$2,250	\$2,785	2	17"	T
18 x 72	any shape	nesting	HRT1 187229	??N Edge	\$2,170	\$2,380	\$2,915	2	17"	T
18 x 72	any shape	stationary	HRT1 187229	??S Edge	\$1,605	\$1,815	\$2,350	2	17"	T
18 x 72	rectangle	folding	HRT1 187229	REF Edge	\$1,985	\$2,175	\$2,655	2	17"	T
18 x 72	rectangle	nesting	HRT1 187229	REN Edge	\$2,115	\$2,305	\$2,785	2	17"	T
18 x 72	rectangle	stationary	HRT1 187229	RES Edge	\$1,550	\$1,740	\$2,220	2	17"	T
18 x 84	any shape	folding	HRT1 188429	??F Inset	\$2,145	\$2,385	\$3,545	2	17"	T
18 x 84	any shape	nesting	HRT1 188429	??N Inset	\$2,275	\$2,515	\$3,675	2	17"	T
18 x 84	any shape	stationary	HRT1 188429	??S Inset	\$1,710	\$1,950	\$3,110	2	17"	T
18 x 84	rectangle	folding	HRT1 188429	REF Inset	\$2,085	\$2,305	\$3,345	2	17"	T
18 x 84	rectangle	nesting	HRT1 188429	REN Inset	\$2,215	\$2,435	\$3,475	2	17"	T
18 x 84	rectangle	stationary	HRT1 188429	RES Inset	\$1,650	\$1,870	\$2,910	2	17"	T
18 x 96	any shape	folding	HRT1 189629	??F Inset	\$2,165	\$2,410	\$3,645	2	17"	T
18 x 96	any shape	nesting	HRT1 189629	??N Inset	\$2,295	\$2,540	\$3,775	2	17"	T
18 x 96	any shape	stationary	HRT1 189629	??S Inset	\$1,730	\$1,975	\$3,210	2	17"	T
18 x 96	rectangle	folding	HRT1 189629	REF Inset	\$2,105	\$2,330	\$3,435	2	17"	T
18 x 96	rectangle	nesting	HRT1 189629	REN Inset	\$2,235	\$2,460	\$3,565	2	17"	T
18 x 96	rectangle	stationary	HRT1 189629	RES Inset	\$1,670	\$1,895	\$3,000	2	17"	T
18 x 108	any shape	folding	HRT1 1810829	??F Inset	\$2,320	\$2,805	\$3,810	2	17"	T
18 x 108	any shape	nesting	HRT1 1810829	??N Inset	\$2,450	\$2,935	\$3,940	2	17"	T
18 x 108	any shape	stationary	HRT1 1810829	??S Inset	\$1,885	\$2,370	\$3,375	2	17"	T
18 x 108	rectangle	folding	HRT1 1810829	REF Inset	\$2,245	\$2,690	\$3,585	2	17"	T
18 x 108	rectangle	nesting	HRT1 1810829	REN Inset	\$2,375	\$2,820	\$3,715	2	17"	T
18 x 108	rectangle	stationary	HRT1 1810829	RES Inset	\$1,810	\$2,255	\$3,150	2	17"	T

POWER & A/V OPTIONS SEE PAGES 8-20

TABLE OPTIONS:

Hidden Wheels	WL	\$50 list per base
Locking Casters	CS	\$20 list per base
Bar Height, stationary tables only.	BH	\$120 list per base
Cafe' Height, stationary tables only.	CH	\$120 list per base
Polished Aluminum	CR	\$110 list per base
Laser cut holes in base - 1.5" x 2.5"	WB	\$55 list per table



NOTE: Nesting tables come standard on locking casters. The Beam nesting system is used for 84" long and 96" long tables

**FINISHES NEEDED:** <http://hi5furniture.com/finishes/>  
 HPL Top: Hi5 Graded-in laminates or Non-Premium W A or Formica  
 Edge Color: Any Hi5 standard  
 Base Finish: Any Hi5 standard

Table Size	Top Shape	Table Function	Model Code:	Base Placement	List Price	List Price	List Price	Base QTY	Base Size	Base Style
18 x 120	any shape	folding	HRT1 1812029	??F Inset	\$2,340	\$2,835	\$3,910	2	17"	T
18 x 120	any shape	nesting	HRT1 1812029	??N Inset	\$2,470	\$2,965	\$4,040	2	17"	T
18 x 120	any shape	stationary	HRT1 1812029	??S Inset	\$1,905	\$2,400	\$3,475	2	17"	T
18 x 120	rectangle	folding	HRT1 1812029	REF Inset	\$2,265	\$2,720	\$3,675	2	17"	T
18 x 120	rectangle	nesting	HRT1 1812029	REN Inset	\$2,395	\$2,850	\$3,805	2	17"	T
18 x 120	rectangle	stationary	HRT1 1812029	RES Inset	\$1,830	\$2,285	\$3,240	2	17"	T

POWER & A/V OPTIONS SEE PAGES 8-20

TABLE OPTIONS:

Hidden Wheels	WL	\$50 list per base
Locking Casters	CS	\$20 list per base
Bar Height, stationary tables only.	BH	\$120 list per base
Cafe' Height, stationary tables only.	CH	\$120 list per base
Polished Aluminum	CR	\$110 list per base
Laser cut holes in base - 1.5" x 2.5"	WB	\$55 list per table



NOTE: Nesting tables come standard on locking casters.  
The Beam nesting system is used for 84" long and 96" long tables

**FINISHES NEEDED:** <http://hi5furniture.com/finishes/>  
HPL Top: Hi5 Graded-in laminates or Non-Premium W A or Formica  
Edge Color: Any Hi5 standard  
Base Finish: Any Hi5 standard

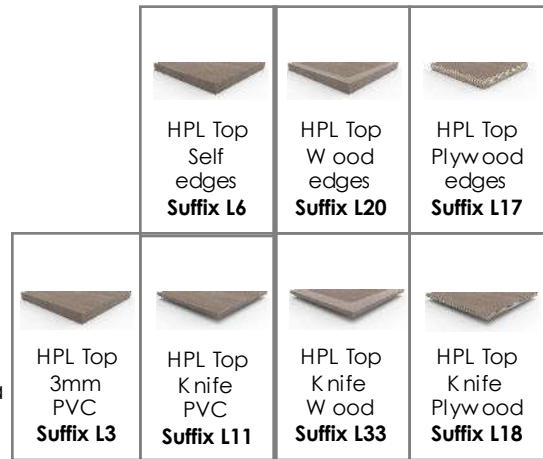

Table Size	Top Shape	Table Function	Model Code:	Base Placement	List Price	List Price	List Price	Base QTY	Base Size	Base Style
24 x 42	any shape	stationary	HRT1 244229	??S Edge	\$1,450	\$1,605	\$2,315	2	20"	T
24 x 42	any shape	nesting	HRT1 244229	??N Edge	\$2,010	\$2,165	\$2,875	2	20"	T
24 x 42	rectangle	stationary	HRT1 244229	RES Edge	\$1,410	\$1,555	\$2,190	2	20"	T
24 x 42	rectangle	nesting	HRT1 244229	REN Edge	\$1,970	\$2,115	\$2,750	2	20"	T
24 x 48	any shape	folding	HRT1 244829	??F Non-Stack	\$2,030	\$2,190	\$2,940	2	20"	T
24 x 48	any shape	stationary	HRT1 244829	??S Edge	\$1,460	\$1,620	\$2,370	2	20"	T
24 x 48	any shape	nesting	HRT1 244829	??N Edge	\$2,020	\$2,180	\$2,930	2	20"	T
24 x 48	rectangle	folding	HRT1 244829	REF Non-Stack	\$1,990	\$2,135	\$2,810	2	20"	T
24 x 48	rectangle	stationary	HRT1 244829	RES Edge	\$1,420	\$1,565	\$2,240	2	20"	T
24 x 48	rectangle	nesting	HRT1 244829	REN Edge	\$1,980	\$2,125	\$2,800	2	20"	T
24 x 60	any shape	folding	HRT1 246029	??F Non-Stack	\$2,085	\$2,260	\$2,900	2	20"	T
24 x 60	any shape	nesting	HRT1 246029	??N Edge	\$2,075	\$2,250	\$2,890	2	20"	T
24 x 60	any shape	stationary	HRT1 246029	??S Edge	\$1,515	\$1,690	\$2,330	2	20"	T
24 x 60	rectangle	folding	HRT1 246029	REF Non-Stack	\$2,040	\$2,200	\$2,770	2	20"	T
24 x 60	rectangle	nesting	HRT1 246029	REN Edge	\$2,030	\$2,190	\$2,760	2	20"	T
24 x 60	rectangle	stationary	HRT1 246029	RES Edge	\$1,470	\$1,630	\$2,200	2	20"	T
24 x 66	any shape	folding	HRT1 246629	??F Edge	\$2,020	\$2,215	\$3,035	2	20"	T
24 x 66	any shape	nesting	HRT1 246629	??N Edge	\$2,150	\$2,345	\$3,165	2	20"	T
24 x 66	any shape	stationary	HRT1 246629	??S Edge	\$1,590	\$1,785	\$2,605	2	20"	T
24 x 66	rectangle	folding	HRT1 246629	REF Edge	\$1,970	\$2,150	\$2,880	2	20"	T
24 x 66	rectangle	nesting	HRT1 246629	REN Edge	\$2,100	\$2,280	\$3,010	2	20"	T
24 x 66	rectangle	stationary	HRT1 246629	RES Edge	\$1,540	\$1,720	\$2,450	2	20"	T
24 x 72	any shape	folding	HRT1 247229	??F Edge	\$2,130	\$2,360	\$2,900	2	20"	T
24 x 72	any shape	nesting	HRT1 247229	??N Edge	\$2,260	\$2,490	\$3,030	2	20"	T
24 x 72	any shape	stationary	HRT1 247229	??S Edge	\$1,700	\$1,930	\$2,470	2	20"	T
24 x 72	rectangle	folding	HRT1 247229	REF Edge	\$2,070	\$2,280	\$2,760	2	20"	T
24 x 72	rectangle	nesting	HRT1 247229	REN Edge	\$2,200	\$2,410	\$2,890	2	20"	T
24 x 72	rectangle	stationary	HRT1 247229	RES Edge	\$1,640	\$1,850	\$2,330	2	20"	T

POWER & A/V OPTIONS SEE PAGES 8-20

TABLE OPTIONS:

- Hidden Wheels
- Locking Casters
- Bar Height, stationary tables only.
- Cafe' Height, stationary tables only.
- Polished Aluminum
- Laser cut holes in base - 1.5" x 2.5"

- WL \$50 list per base
- CS \$20 list per base
- BH \$120 list per base
- CH \$120 list per base
- CR \$110 list per base
- WB \$55 list per table



NOTE: Nesting tables come standard on locking casters.  
The Beam nesting system is used for 84" long and 96" long tables

**FINISHES NEEDED:** <http://hi5furniture.com/finishes/>  
HPL Top: Hi5 Graded-in laminates or Non-Premium W A or Formica  
Edge Color: Any Hi5 standard  
Base Finish: Any Hi5 standard







 HPL Top Self edges <b>Suffix L6</b>	 HPL Top Wood edges <b>Suffix L20</b>	 HPL Top Plywood edges <b>Suffix L17</b>	
 HPL Top 3mm PVC <b>Suffix L3</b>	 HPL Top Knife PVC <b>Suffix L11</b>	 HPL Top Knife Wood <b>Suffix L33</b>	 HPL Top Knife Plywood <b>Suffix L18</b>

Table Size	Top Shape	Table Function	Model Code:	Base Placement	List Price	List Price	List Price	Base QTY	Base Size	Base Style
24 x 84	any shape	folding	HRT1 248429	??F Inset	\$2,235	\$2,495	\$3,680	2	20"	T
24 x 84	any shape	nesting	HRT1 248429	??N Inset	\$2,365	\$2,625	\$3,810	2	20"	T
24 x 84	any shape	stationary	HRT1 248429	??S Inset	\$1,805	\$2,065	\$3,250	2	20"	T
24 x 84	rectangle	folding	HRT1 248429	REF Inset	\$2,170	\$2,410	\$3,470	2	20"	T
24 x 84	rectangle	nesting	HRT1 248429	REN Inset	\$2,300	\$2,540	\$3,600	2	20"	T
24 x 84	rectangle	stationary	HRT1 248429	RES Inset	\$1,740	\$1,980	\$3,040	2	20"	T
24 x 96	any shape	folding	HRT1 249629	??F Inset	\$2,245	\$2,510	\$3,770	2	20"	T
24 x 96	any shape	nesting	HRT1 249629	??N Inset	\$2,375	\$2,640	\$3,900	2	20"	T
24 x 96	any shape	stationary	HRT1 249629	??S Inset	\$1,815	\$2,080	\$3,340	2	20"	T
24 x 96	rectangle	folding	HRT1 249629	REF Inset	\$2,180	\$2,425	\$3,550	2	20"	T
24 x 96	rectangle	nesting	HRT1 249629	REN Inset	\$2,310	\$2,555	\$3,680	2	20"	T
24 x 96	rectangle	stationary	HRT1 249629	RES Inset	\$1,750	\$1,995	\$3,120	2	20"	T
24 x 108	any shape	folding	HRT1 2410829	??F Inset	\$2,365	\$2,865	\$3,955	2	20"	T
24 x 108	any shape	nesting	HRT1 2410829	??N Inset	\$2,495	\$2,995	\$4,085	2	20"	T
24 x 108	any shape	stationary	HRT1 2410829	??S Inset	\$1,935	\$2,435	\$3,525	2	20"	T
24 x 108	rectangle	folding	HRT1 2410829	REF Inset	\$2,290	\$2,750	\$3,720	2	20"	T
24 x 108	rectangle	nesting	HRT1 2410829	REN Inset	\$2,420	\$2,880	\$3,850	2	20"	T
24 x 108	rectangle	stationary	HRT1 2410829	RES Inset	\$1,860	\$2,320	\$3,290	2	20"	T
24 x 120	any shape	folding	HRT1 2412029	??F Inset	\$2,390	\$2,900	\$4,045	2	20"	T
24 x 120	any shape	nesting	HRT1 2412029	??N Inset	\$2,520	\$3,030	\$4,175	2	20"	T
24 x 120	any shape	stationary	HRT1 2412029	??S Inset	\$1,960	\$2,470	\$3,615	2	20"	T
24 x 120	rectangle	folding	HRT1 2412029	REF Inset	\$2,310	\$2,780	\$3,800	2	20"	T
24 x 120	rectangle	nesting	HRT1 2412029	REN Inset	\$2,440	\$2,910	\$3,930	2	20"	T
24 x 120	rectangle	stationary	HRT1 2412029	RES Inset	\$1,880	\$2,350	\$3,370	2	20"	T

POWER & A/V OPTIONS SEE PAGES 8-20

TABLE OPTIONS:

Hidden Wheels	WL	\$50 list per base
Locking Casters	CS	\$20 list per base
Bar Height, stationary tables only.	BH	\$120 list per base
Cafe' Height, stationary tables only.	CH	\$120 list per base
Polished Aluminum	CR	\$110 list per base
Laser cut holes in base - 1.5" x 2.5"	WB	\$55 list per table



NOTE: Nesting tables come standard on locking casters.  
The Beam nesting system is used for 84" long and 96" long tables

**FINISHES NEEDED:** <http://hi5furniture.com/finishes/>  
HPL Top: Hi5 Graded-in laminates or Non-Premium W A or Formica  
Edge Color: Any Hi5 standard  
Base Finish: Any Hi5 standard







 HPL Top Self edges <b>Suffix L6</b>	 HPL Top Wood edges <b>Suffix L20</b>	 HPL Top Plywood edges <b>Suffix L17</b>	
 HPL Top 3mm PVC <b>Suffix L3</b>	 HPL Top Knife PVC <b>Suffix L11</b>	 HPL Top Knife Wood <b>Suffix L33</b>	 HPL Top Knife Plywood <b>Suffix L18</b>

Table Size	Top Shape	Table Function	Model Code:	Base Placement	List Price	List Price	List Price	Base QTY	Base Size	Base Style
30 x 42	any shape	stationary	HRT1 304229	??S Edge	\$1,555	\$1,730	\$2,455	2	26"	T
30 x 42	any shape	nesting	HRT1 304229	??N Edge	\$2,115	\$2,290	\$3,015	2	26"	T
30 x 42	rectangle	stationary	HRT1 304229	RES Edge	\$1,510	\$1,670	\$2,320	2	26"	T
30 x 42	rectangle	nesting	HRT1 304229	REN Edge	\$2,070	\$2,230	\$2,880	2	26"	T
30 x 48	any shape	folding	HRT1 304829	??F Non-Stack	\$2,130	\$2,310	\$3,065	2	26"	T
30 x 48	any shape	stationary	HRT1 304829	??S Edge	\$1,565	\$1,745	\$2,500	2	26"	T
30 x 48	any shape	nesting	HRT1 304829	??N Edge	\$2,125	\$2,305	\$3,060	2	26"	T
30 x 48	rectangle	folding	HRT1 304829	REF Non-Stack	\$2,085	\$2,250	\$2,925	2	26"	T
30 x 48	rectangle	stationary	HRT1 304829	RES Edge	\$1,520	\$1,685	\$2,360	2	26"	T
30 x 48	rectangle	nesting	HRT1 304829	REN Edge	\$2,080	\$2,245	\$2,920	2	26"	T
30 x 60	any shape	folding	HRT1 306029	??F Non-Stack	\$2,195	\$2,390	\$3,045	2	26"	T
30 x 60	any shape	nesting	HRT1 306029	??N Edge	\$2,190	\$2,385	\$3,040	2	26"	T
30 x 60	any shape	stationary	HRT1 306029	??S Edge	\$1,630	\$1,825	\$2,480	2	26"	T
30 x 60	rectangle	folding	HRT1 306029	REF Non-Stack	\$2,145	\$2,325	\$2,905	2	26"	T
30 x 60	rectangle	nesting	HRT1 306029	REN Edge	\$2,140	\$2,320	\$2,900	2	26"	T
30 x 60	rectangle	stationary	HRT1 306029	RES Edge	\$1,580	\$1,760	\$2,340	2	26"	T
30 x 66	any shape	folding	HRT1 306629	??F Edge	\$2,130	\$2,350	\$3,200	2	26"	T
30 x 66	any shape	nesting	HRT1 306629	??N Edge	\$2,265	\$2,485	\$3,335	2	26"	T
30 x 66	any shape	stationary	HRT1 306629	??S Edge	\$1,705	\$1,925	\$2,775	2	26"	T
30 x 66	rectangle	folding	HRT1 306629	REF Edge	\$2,075	\$2,280	\$3,035	2	26"	T
30 x 66	rectangle	nesting	HRT1 306629	REN Edge	\$2,210	\$2,415	\$3,170	2	26"	T
30 x 66	rectangle	stationary	HRT1 306629	RES Edge	\$1,650	\$1,855	\$2,610	2	26"	T
30 x 72	any shape	folding	HRT1 307229	??F Edge	\$2,250	\$2,505	\$3,045	2	26"	T
30 x 72	any shape	nesting	HRT1 307229	??N Edge	\$2,385	\$2,640	\$3,180	2	26"	T
30 x 72	any shape	stationary	HRT1 307229	??S Edge	\$1,825	\$2,080	\$2,620	2	26"	T
30 x 72	rectangle	folding	HRT1 307229	REF Edge	\$2,185	\$2,420	\$2,895	2	26"	T
30 x 72	rectangle	nesting	HRT1 307229	REN Edge	\$2,320	\$2,555	\$3,030	2	26"	T
30 x 72	rectangle	stationary	HRT1 307229	RES Edge	\$1,760	\$1,995	\$2,470	2	26"	T

POWER & A/V OPTIONS SEE PAGES 8-20

TABLE OPTIONS:

Hidden Wheels	WL	\$50 list per base
Locking Casters	CS	\$20 list per base
Bar Height, stationary tables only.	BH	\$120 list per base
Cafe' Height, stationary tables only.	CH	\$120 list per base
Polished Aluminum	CR	\$110 list per base
Laser cut holes in base - 1.5" x 2.5"	WB	\$55 list per table





NOTE: Nesting tables come standard on locking casters.  
The Beam nesting system is used for 84" long and 96" long tables

**FINISHES NEEDED:** <http://hi5furniture.com/finishes/>  
HPL Top: Hi5 Graded-in laminates or Non-Premium W A or Formica  
Edge Color: Any Hi5 standard  
Base Finish: Any Hi5 standard

HPL Top Self edges <b>Suffix L6</b>	HPL Top Wood edges <b>Suffix L20</b>	HPL Top Plywood edges <b>Suffix L17</b>	
HPL Top 3mm PVC <b>Suffix L3</b>	HPL Top Knife PVC <b>Suffix L11</b>	HPL Top Knife Wood <b>Suffix L33</b>	HPL Top Knife Plywood <b>Suffix L18</b>

Table Size	Top Shape	Table Function	Model Code:	Base Placement	List Price	List Price	List Price	Base QTY	Base Size	Base Style
30 x 84	any shape	folding	HRT1 308429	??F Inset	\$2,380	\$2,675	\$3,860	2	26"	T
30 x 84	any shape	nesting	HRT1 308429	??N Inset	\$2,515	\$2,810	\$3,995	2	26"	T
30 x 84	any shape	stationary	HRT1 308429	??S Inset	\$1,955	\$2,250	\$3,435	2	26"	T
30 x 84	rectangle	folding	HRT1 308429	REF Inset	\$2,305	\$2,575	\$3,635	2	26"	T
30 x 84	rectangle	nesting	HRT1 308429	REN Inset	\$2,440	\$2,710	\$3,770	2	26"	T
30 x 84	rectangle	stationary	HRT1 308429	RES Inset	\$1,880	\$2,150	\$3,210	2	26"	T
30 x 96	any shape	folding	HRT1 309629	??F Inset	\$2,390	\$2,690	\$3,950	2	26"	T
30 x 96	any shape	nesting	HRT1 309629	??N Inset	\$2,525	\$2,825	\$4,085	2	26"	T
30 x 96	any shape	stationary	HRT1 309629	??S Inset	\$1,965	\$2,265	\$3,525	2	26"	T
30 x 96	rectangle	folding	HRT1 309629	REF Inset	\$2,315	\$2,590	\$3,715	2	26"	T
30 x 96	rectangle	nesting	HRT1 309629	REN Inset	\$2,450	\$2,725	\$3,850	2	26"	T
30 x 96	rectangle	stationary	HRT1 309629	RES Inset	\$1,890	\$2,165	\$3,290	2	26"	T
30 x 108	any shape	folding	HRT1 3010829	??F Inset	\$2,540	\$3,110	\$4,170	2	26"	T
30 x 108	any shape	nesting	HRT1 3010829	??N Inset	\$2,675	\$3,245	\$4,305	2	26"	T
30 x 108	any shape	stationary	HRT1 3010829	??S Inset	\$2,115	\$2,685	\$3,745	2	26"	T
30 x 108	rectangle	folding	HRT1 3010829	REF Inset	\$2,455	\$2,980	\$3,915	2	26"	T
30 x 108	rectangle	nesting	HRT1 3010829	REN Inset	\$2,590	\$3,115	\$4,050	2	26"	T
30 x 108	rectangle	stationary	HRT1 3010829	RES Inset	\$2,030	\$2,555	\$3,490	2	26"	T
30 x 120	any shape	folding	HRT1 3012029	??F Inset	\$2,550	\$3,125	\$4,255	2	26"	T
30 x 120	any shape	nesting	HRT1 3012029	??N Inset	\$2,685	\$3,260	\$4,390	2	26"	T
30 x 120	any shape	stationary	HRT1 3012029	??S Inset	\$2,125	\$2,700	\$3,830	2	26"	T
30 x 120	rectangle	folding	HRT1 3012029	REF Inset	\$2,465	\$2,995	\$3,995	2	26"	T
30 x 120	rectangle	nesting	HRT1 3012029	REN Inset	\$2,600	\$3,130	\$4,130	2	26"	T
30 x 120	rectangle	stationary	HRT1 3012029	RES Inset	\$2,040	\$2,570	\$3,570	2	26"	T

POWER & A/V OPTIONS SEE PAGES 8-20

TABLE OPTIONS:

- Hidden Wheels
- Locking Casters
- Bar Height, stationary tables only.
- Cafe' Height, stationary tables only.
- Polished Aluminum
- Laser cut holes in base - 1.5" x 2.5"

- WL \$50 list per base
- CS \$20 list per base
- BH \$120 list per base
- CH \$120 list per base
- CR \$110 list per base
- WB \$55 list per table



NOTE: Nesting tables come standard on locking casters.  
The Beam nesting system is used for 84" long and 96" long tables

**FINISHES NEEDED:** <http://hi5furniture.com/finishes/>  
HPL Top: Hi5 Graded-in laminates or Non-Premium W A or Formica  
Edge Color: Any Hi5 standard  
Base Finish: Any Hi5 standard

HPL Top Self edges <b>Suffix L6</b>	HPL Top Wood edges <b>Suffix L20</b>	HPL Top Plywood edges <b>Suffix L17</b>	
HPL Top 3mm PVC <b>Suffix L3</b>	HPL Top Knife PVC <b>Suffix L11</b>	HPL Top Knife Wood <b>Suffix L33</b>	HPL Top Knife Plywood <b>Suffix L18</b>

Table Size	Top Shape	Table Function	Model Code:	Base Placement	List Price	List Price	List Price	Base QTY	Base Size	Base Style
36 x 42	any shape	stationary	HRT1 364229	??S Edge	\$1,610	\$1,800	\$2,555	2	26"	T
36 x 42	any shape	nesting	HRT1 364229	??N Edge	\$2,170	\$2,360	\$3,115	2	26"	T
36 x 42	rectangle	stationary	HRT1 364229	RES Edge	\$1,560	\$1,735	\$2,410	2	26"	T
36 x 42	rectangle	nesting	HRT1 364229	REN Edge	\$2,120	\$2,295	\$2,970	2	26"	T
36 x 48	any shape	folding	HRT1 364829	??F Non-Stack	\$2,265	\$2,485	\$3,275	2	26"	T
36 x 48	any shape	stationary	HRT1 364829	??S Edge	\$1,700	\$1,920	\$2,710	2	26"	T
36 x 48	any shape	nesting	HRT1 364829	??N Edge	\$2,260	\$2,480	\$3,270	2	26"	T
36 x 48	rectangle	folding	HRT1 364829	REF Non-Stack	\$2,135	\$2,315	\$3,025	2	26"	T
36 x 48	rectangle	stationary	HRT1 364829	RES Edge	\$1,570	\$1,750	\$2,460	2	26"	T
36 x 48	rectangle	nesting	HRT1 364829	REN Edge	\$2,130	\$2,310	\$3,020	2	26"	T
36 x 60	any shape	folding	HRT1 366029	??F Non-Stack	\$2,305	\$2,535	\$3,425	2	26"	T
36 x 60	any shape	nesting	HRT1 366029	??N Edge	\$2,300	\$2,530	\$3,420	2	26"	T
36 x 60	any shape	stationary	HRT1 366029	??S Edge	\$1,740	\$1,970	\$2,860	2	26"	T
36 x 60	rectangle	folding	HRT1 366029	REF Non-Stack	\$2,215	\$2,420	\$3,175	2	26"	T
36 x 60	rectangle	nesting	HRT1 366029	REN Edge	\$2,210	\$2,415	\$3,170	2	26"	T
36 x 60	rectangle	stationary	HRT1 366029	RES Edge	\$1,650	\$1,855	\$2,610	2	26"	T
36 x 66	any shape	folding	HRT1 366629	??F Edge	\$2,325	\$2,605	\$3,755	2	26"	T
36 x 66	any shape	nesting	HRT1 366629	??N Edge	\$2,460	\$2,740	\$3,890	2	26"	T
36 x 66	any shape	stationary	HRT1 366629	??S Edge	\$1,900	\$2,180	\$3,330	2	26"	T
36 x 66	rectangle	folding	HRT1 366629	REF Edge	\$2,245	\$2,500	\$3,505	2	26"	T
36 x 66	rectangle	nesting	HRT1 366629	REN Edge	\$2,380	\$2,635	\$3,640	2	26"	T
36 x 66	rectangle	stationary	HRT1 366629	RES Edge	\$1,820	\$2,075	\$3,080	2	26"	T
36 x 72	any shape	folding	HRT1 367229	??F Edge	\$2,335	\$2,615	\$3,795	2	26"	T
36 x 72	any shape	nesting	HRT1 367229	??N Edge	\$2,470	\$2,750	\$3,930	2	26"	T
36 x 72	any shape	stationary	HRT1 367229	??S Edge	\$1,910	\$2,190	\$3,370	2	26"	T
36 x 72	rectangle	folding	HRT1 367229	REF Edge	\$2,255	\$2,510	\$3,545	2	26"	T
36 x 72	rectangle	nesting	HRT1 367229	REN Edge	\$2,390	\$2,645	\$3,680	2	26"	T
36 x 72	rectangle	stationary	HRT1 367229	RES Edge	\$1,830	\$2,085	\$3,120	2	26"	T

POWER & A/V OPTIONS SEE PAGES 8-20

TABLE OPTIONS:

Hidden Wheels	WL	\$50 list per base
Locking Casters	CS	\$20 list per base
Bar Height, stationary tables only.	BH	\$120 list per base
Cafe' Height, stationary tables only.	CH	\$120 list per base
Polished Aluminum	CR	\$110 list per base
Laser cut holes in base - 1.5" x 2.5"	WB	\$55 list per table



NOTE: Nesting tables come standard on locking casters.  
The Beam nesting system is used for 84" long and 96" long tables

**FINISHES NEEDED:** <http://hi5furniture.com/finishes/>  
HPL Top: Hi5 Graded-in laminates or Non-Premium W A or Formica  
Edge Color: Any Hi5 standard  
Base Finish: Any Hi5 standard

HPL Top Self edges <b>Suffix L6</b>	HPL Top Wood edges <b>Suffix L20</b>	HPL Top Plywood edges <b>Suffix L17</b>	
HPL Top 3mm PVC <b>Suffix L3</b>	HPL Top Knife PVC <b>Suffix L11</b>	HPL Top Knife Wood <b>Suffix L33</b>	HPL Top Knife Plywood <b>Suffix L18</b>

Table Size	Top Shape	Table Function	Model Code:	Base Placement	List Price	List Price	List Price	Base QTY	Base Size	Base Style
36 x 84	any shape	folding	HRT2368429	??F Inset	\$2,495	\$2,825	\$4,015	2	35"	T
36 x 84	any shape	stationary	HRT2368429	??S Inset	\$2,610	\$2,940	\$4,130	2	35"	T
36 x 84	rectangle	folding	HRT2368429	REF Inset	\$2,405	\$2,705	\$3,765	2	35"	T
36 x 84	rectangle	stationary	HRT2368429	RES Inset	\$2,520	\$2,820	\$3,880	2	35"	T
36 x 96	any shape	folding	HRT2369629	??F Inset	\$2,505	\$2,835	\$4,105	2	35"	T
36 x 96	any shape	stationary	HRT2369629	??S Inset	\$2,620	\$2,950	\$4,220	2	35"	T
36 x 96	rectangle	folding	HRT2369629	REF Inset	\$2,415	\$2,720	\$3,855	2	35"	T
36 x 96	rectangle	stationary	HRT2369629	RES Inset	\$2,530	\$2,835	\$3,970	2	35"	T
36 x 108	any shape	folding	HRT23610829	??F Inset	\$2,655	\$3,280	\$4,325	2	35"	T
36 x 108	any shape	stationary	HRT23610829	??S Inset	\$3,530	\$4,155	\$5,200	3	35"	T
36 x 108	rectangle	folding	HRT23610829	REF Inset	\$2,575	\$3,160	\$4,075	2	35"	T
36 x 108	rectangle	stationary	HRT23610829	RES Inset	\$3,450	\$4,035	\$4,950	3	35"	T
36 x 120	any shape	folding	HRT23612029	??F Inset	\$2,675	\$3,310	\$4,405	2	35"	T
36 x 120	any shape	stationary	HRT23612029	??S Inset	\$3,550	\$4,185	\$5,280	3	35"	T
36 x 120	rectangle	folding	HRT23612029	REF Inset	\$2,595	\$3,190	\$4,155	2	35"	T
36 x 120	rectangle	stationary	HRT23612029	RES Inset	\$3,470	\$4,065	\$5,030	3	35"	T
36 x 132	any shape	stationary	HRT23613229	??S Inset	\$5,700	\$7,030	\$8,300	4	35"	TT
36 x 132	rectangle	stationary	HRT23613229	RES Inset	\$5,350	\$6,505	\$7,630	4	35"	TT
36 x 144	any shape	stationary	HRT23614369	??S Inset	\$5,730	\$7,075	\$8,460	4	35"	TT
36 x 144	rectangle	stationary	HRT23614369	RES Inset	\$5,410	\$6,595	\$7,930	4	35"	TT
36 x 168	any shape	stationary	HRT23616829	??S Inset	\$6,010	\$7,495	\$8,860	4	35"	TT
36 x 168	rectangle	stationary	HRT23616829	RES Inset	\$5,690	\$7,015	\$8,330	4	35"	TT

POWER & A/V OPTIONS SEE PAGES 8-20

TABLE OPTIONS:

- Hidden Wheels
- Locking Casters
- Bar Height, stationary tables only.
- Cafe' Height, stationary tables only.
- Polished Aluminum
- Laser cut holes in base - 1.5" x 2.5"

- WL \$50 list per base
- CS \$20 list per base
- BH \$120 list per base
- CH \$120 list per base
- CR \$110 list per base
- WB \$55 list per table



NOTE: Nesting tables come standard on locking casters. The Beam nesting system is used for 84" long and 96" long tables

**FINISHES NEEDED:** <http://hi5furniture.com/finishes/>  
 HPL Top: Hi5 Graded-in laminates or Non-Premium W A or Formica  
 Edge Color: Any Hi5 standard  
 Base Finish: Any Hi5 standard

Table Size	Top Shape	Table Function	Model Code:	Base Placement	List Price	List Price	List Price	Base QTY	Base Size	Base Style
36 x 192	any shape	stationary	HRT23619229	??SInset	\$6,800	\$8,300	\$9,770	5	35"	TT
36 x 192	rectangle	stationary	HRT23619229	RES Inset	\$6,480	\$7,820	\$9,240	5	35"	TT
36 x 216	any shape	stationary	HRT23621629	??SInset	\$7,080	\$8,720	\$10,170	5	35"	TT
36 x 216	rectangle	stationary	HRT23621629	RES Inset	\$6,760	\$8,240	\$9,630	5	35"	TT
36 x 240	any shape	stationary	HRT23624029	??SInset	\$7,110	\$8,765	\$10,330	5	35"	TT
36 x 240	rectangle	stationary	HRT23624029	RES Inset	\$6,790	\$8,285	\$9,780	5	35"	TT

POWER & A/V OPTIONS SEE PAGES 8-20

TABLE OPTIONS:

- Hidden Wheels
- Locking Casters
- Bar Height, stationary tables only.
- Cafe' Height, stationary tables only.
- Polished Aluminum
- Laser cut holes in base - 1.5" x 2.5"

- WL \$50 list per base
- CS \$20 list per base
- BH \$120 list per base
- CH \$120 list per base
- CR \$110 list per base
- WB \$55 list per table



NOTE: Nesting tables come standard on locking casters.  
The Beam nesting system is used for 84" long and 96" long tables

**FINISHES NEEDED:** <http://hi5furniture.com/finishes/>  
HPL Top: Hi5 Graded-in laminates or Non-Premium W A or Formica  
Edge Color: Any Hi5 standard  
Base Finish: Any Hi5 standard

HPL Top Self edges <b>Suffix L6</b>	HPL Top Wood edges <b>Suffix L20</b>	HPL Top Plywood edges <b>Suffix L17</b>	
HPL Top 3mm PVC <b>Suffix L3</b>	HPL Top Knife PVC <b>Suffix L11</b>	HPL Top Knife Wood <b>Suffix L33</b>	HPL Top Knife Plywood <b>Suffix L18</b>

Table Size	Top Shape	Table Function	Model Code:	Base Placement	List Price	List Price	List Price	Base QTY	Base Size	Base Style
42 x 48	any shape	folding	HRT2 424829	??F Non-Stack	\$3,375	\$3,605	\$4,425	2	35"	TT
42 x 48	any shape	stationary	HRT2 424829	??S Edge	\$2,280	\$2,510	\$3,330	2	35"	TT
42 x 48	rectangle	folding	HRT2 424829	REF Non-Stack	\$3,305	\$3,515	\$4,215	2	35"	TT
42 x 48	rectangle	stationary	HRT2 424829	RES Edge	\$2,210	\$2,420	\$3,120	2	35"	TT
42 x 60	any shape	folding	HRT2 426029	??F Non-Stack	\$3,575	\$3,865	\$4,965	2	35"	TT
42 x 60	any shape	stationary	HRT2 426029	??S Inset	\$2,480	\$2,770	\$3,870	2	35"	TT
42 x 60	rectangle	folding	HRT2 426029	REF Non-Stack	\$3,505	\$3,775	\$4,765	2	35"	TT
42 x 60	rectangle	stationary	HRT2 426029	RES Inset	\$2,410	\$2,680	\$3,670	2	35"	TT
42 x 66	any shape	folding	HRT2 426629	??F Inset	\$3,535	\$3,855	\$4,965	2	35"	TT
42 x 66	any shape	stationary	HRT2 426629	??S Inset	\$2,580	\$2,900	\$4,010	2	35"	TT
42 x 66	rectangle	folding	HRT2 426629	REF Inset	\$3,465	\$3,765	\$4,755	2	35"	TT
42 x 66	rectangle	stationary	HRT2 426629	RES Inset	\$2,510	\$2,810	\$3,800	2	35"	TT
42 x 72	any shape	folding	HRT2 427229	??F Inset	\$3,545	\$3,870	\$5,005	2	35"	TT
42 x 72	any shape	stationary	HRT2 427229	??S Inset	\$2,590	\$2,915	\$4,050	2	35"	TT
42 x 72	rectangle	folding	HRT2 427229	REF Inset	\$3,465	\$3,765	\$4,795	2	35"	TT
42 x 72	rectangle	stationary	HRT2 427229	RES Inset	\$2,510	\$2,810	\$3,840	2	35"	TT
42 x 84	any shape	folding	HRT2 428429	??F Inset	\$3,745	\$4,130	\$5,275	2	35"	TT
42 x 84	any shape	stationary	HRT2 428429	??S Inset	\$2,790	\$3,175	\$4,320	2	35"	TT
42 x 84	rectangle	folding	HRT2 428429	REF Inset	\$3,665	\$4,025	\$5,065	2	35"	TT
42 x 84	rectangle	stationary	HRT2 428429	RES Inset	\$2,710	\$3,070	\$4,110	2	35"	TT
42 x 96	any shape	folding	HRT2 429629	??F Inset	\$3,765	\$4,155	\$5,355	2	35"	TT
42 x 96	any shape	stationary	HRT2 429629	??S Inset	\$2,810	\$3,200	\$4,400	2	35"	TT
42 x 96	rectangle	folding	HRT2 429629	REF Inset	\$3,685	\$4,050	\$5,145	2	35"	TT
42 x 96	rectangle	stationary	HRT2 429629	RES Inset	\$2,730	\$3,095	\$4,190	2	35"	TT

POWER & A/V OPTIONS SEE PAGES 8-20

TABLE OPTIONS:

- Hidden Wheels
- Locking Casters
- Bar Height, stationary tables only.
- Cafe' Height, stationary tables only.
- Polished Aluminum
- Laser cut holes in base - 1.5" x 2.5"

- WL \$50 list per base
- CS \$20 list per base
- BH \$120 list per base
- CH \$120 list per base
- CR \$110 list per base
- WB \$55 list per table



NOTE: Nesting tables come standard on locking casters.  
The Beam nesting system is used for 84" long and 96" long tables

**FINISHES NEEDED:** <http://hi5furniture.com/finishes/>  
HPL Top: Hi5 Graded-in laminates or Non-Premium W A or Formica  
Edge Color: Any Hi5 standard  
Base Finish: Any Hi5 standard

HPL Top 3mm PVC Suffix L3	HPL Top Knife PVC Suffix L11	HPL Top K nife W ood Suffix L33	HPL Top K nife Plyw ood Suffix L18
HPL Top Self edges Suffix L6	HPL Top W ood edges Suffix L20	HPL Top Plyw ood edges Suffix L17	

Table Size	Top Shape	Table Function	Model Code:	Base Placement	List Price	List Price	List Price	Base QTY	Base Size	Base Style
42 x 108	any shape	folding	HRT2 4210829 ??F	Inset	\$3,010	\$3,755	\$4,670	2	35"	TT
42 x 108	any shape	stationary	HRT2 4210829 ??S	Inset	\$3,770	\$4,515	\$5,430	3	35"	TT
42 x 108	rectangle	folding	HRT2 4210829 REF	Inset	\$2,930	\$3,635	\$4,460	2	35"	TT
42 x 108	rectangle	stationary	HRT2 4210829 RES	Inset	\$3,690	\$4,395	\$5,220	3	35"	TT
42 x 120	any shape	folding	HRT2 4212029 ??F	Inset	\$3,020	\$3,770	\$4,750	2	35"	TT
42 x 120	any shape	stationary	HRT2 4212029 ??S	Inset	\$3,780	\$4,530	\$5,510	3	35"	TT
42 x 120	rectangle	folding	HRT2 4212029 REF	Inset	\$2,950	\$3,665	\$4,550	2	35"	TT
42 x 120	rectangle	stationary	HRT2 4212029 RES	Inset	\$3,710	\$4,425	\$5,310	3	35"	TT
42 x 132	any shape	stationary	HRT2 4213229 ??S	Inset	\$5,960	\$7,420	\$8,550	4	35"	TT
42 x 132	rectangle	stationary	HRT2 4213229 RES	Inset	\$5,610	\$6,895	\$7,910	4	35"	TT
42 x 144	any shape	stationary	HRT2 4214429 ??S	Inset	\$5,980	\$7,450	\$8,700	4	35"	TT
42 x 144	rectangle	stationary	HRT2 4214429 RES	Inset	\$5,680	\$7,000	\$8,250	4	35"	TT
42 x 168	any shape	stationary	HRT2 4216829 ??S	Inset	\$6,350	\$8,005	\$9,180	4	35"	TT
42 x 168	rectangle	stationary	HRT2 4216829 RES	Inset	\$6,040	\$7,540	\$8,730	4	35"	TT
42 x 192	any shape	stationary	HRT2 4219229 ??S	Inset	\$7,140	\$8,810	\$10,100	5	35"	TT
42 x 192	rectangle	stationary	HRT2 4219229 RES	Inset	\$6,830	\$8,345	\$9,640	5	35"	TT
42 x 216	any shape	stationary	HRT2 4221629 ??S	Inset	\$7,500	\$9,350	\$10,580	5	35"	TT
42 x 216	rectangle	stationary	HRT2 4221629 RES	Inset	\$7,190	\$8,885	\$10,110	5	35"	TT
42 x 240	any shape	stationary	HRT2 4224029 ??S	Inset	\$7,530	\$9,395	\$10,730	5	35"	TT
42 x 240	rectangle	stationary	HRT2 4224029 RES	Inset	\$7,220	\$8,930	\$10,260	5	35"	TT

POWER & A/V OPTIONS SEE PAGES 8-20

TABLE OPTIONS:

- Hidden Wheels
- Locking Casters
- Bar Height, stationary tables only.
- Cafe' Height, stationary tables only.
- Polished Aluminum
- Laser cut holes in base - 1.5" x 2.5"

- WL \$50 list per base
- CS \$20 list per base
- BH \$120 list per base
- CH \$120 list per base
- CR \$110 list per base
- WB \$55 list per table



NOTE: Nesting tables come standard on locking casters.  
The Beam nesting system is used for 84" long and 96" long tables

**FINISHES NEEDED:** <http://hi5furniture.com/finishes/>  
HPL Top: Hi5 Graded-in laminates or Non-Premium W A or Formica  
Edge Color: Any Hi5 standard  
Base Finish: Any Hi5 standard

HPL Top Self edges <b>Suffix L6</b>	HPL Top W ood edges <b>Suffix L20</b>	HPL Top Plyw ood edges <b>Suffix L17</b>	
HPL Top 3mm PVC <b>Suffix L3</b>	HPL Top Knife PVC <b>Suffix L11</b>	HPL Top K nife W ood <b>Suffix L33</b>	HPL Top K nife Plyw ood <b>Suffix L18</b>

Table Size	Top Shape	Table Function	Model Code:	Base Placement	List Price	List Price	List Price	Base QTY	Base Size	Base Style
48 x 60	any shape	folding	HRT2 486029 ??F	Non-Stack	\$3,575	\$3,865	\$5,015	2	35"	TT
48 x 60	any shape	stationary	HRT2 486029 ??S	Inset	\$2,480	\$2,770	\$3,920	2	35"	TT
48 x 60	rectangle	folding	HRT2 486029 REF	Non-Stack	\$3,505	\$3,775	\$4,805	2	35"	TT
48 x 60	rectangle	stationary	HRT2 486029 RES	Inset	\$2,410	\$2,680	\$3,710	2	35"	TT
48 x 66	any shape	folding	HRT2 486629 ??F	Inset	\$3,535	\$3,855	\$5,005	2	35"	TT
48 x 66	any shape	stationary	HRT2 486629 ??S	Inset	\$2,580	\$2,900	\$4,050	2	35"	TT
48 x 66	rectangle	folding	HRT2 486629 REF	Inset	\$3,465	\$3,765	\$4,795	2	35"	TT
48 x 66	rectangle	stationary	HRT2 486629 RES	Inset	\$2,510	\$2,810	\$3,840	2	35"	TT
48 x 72	any shape	folding	HRT2 487229 ??F	Inset	\$3,545	\$3,870	\$5,045	2	35"	TT
48 x 72	any shape	stationary	HRT2 487229 ??S	Inset	\$2,590	\$2,915	\$4,090	2	35"	TT
48 x 72	rectangle	folding	HRT2 487229 REF	Inset	\$3,465	\$3,765	\$4,835	2	35"	TT
48 x 72	rectangle	stationary	HRT2 487229 RES	Inset	\$2,510	\$2,810	\$3,880	2	35"	TT
48 x 84	any shape	folding	HRT2 488429 ??F	Inset	\$3,745	\$4,130	\$5,315	2	35"	TT
48 x 84	any shape	stationary	HRT2 488429 ??S	Inset	\$2,790	\$3,175	\$4,360	2	35"	TT
48 x 84	rectangle	folding	HRT2 488429 REF	Inset	\$3,665	\$4,025	\$5,105	2	35"	TT
48 x 84	rectangle	stationary	HRT2 488429 RES	Inset	\$2,710	\$3,070	\$4,150	2	35"	TT
48 x 96	any shape	folding	HRT2 489629 ??F	Inset	\$3,765	\$4,155	\$5,395	2	35"	TT
48 x 96	any shape	stationary	HRT2 489629 ??S	Inset	\$2,810	\$3,200	\$4,440	2	35"	TT
48 x 96	rectangle	folding	HRT2 489629 REF	Inset	\$3,685	\$4,050	\$5,185	2	35"	TT
48 x 96	rectangle	stationary	HRT2 489629 RES	Inset	\$2,730	\$3,095	\$4,230	2	35"	TT
48 x 108	any shape	folding	HRT2 4810829 ??F	Inset	\$3,010	\$3,755	\$4,710	2	35"	TT
48 x 108	any shape	stationary	HRT2 4810829 ??S	Inset	\$3,770	\$4,515	\$5,470	3	35"	TT
48 x 108	rectangle	folding	HRT2 4810829 REF	Inset	\$2,930	\$3,635	\$4,500	2	35"	TT
48 x 108	rectangle	stationary	HRT2 4810829 RES	Inset	\$3,690	\$4,395	\$5,260	3	35"	TT

POWER & A/V OPTIONS SEE PAGES 8-20

TABLE OPTIONS:

- Hidden Wheels
- Locking Casters
- Bar Height, stationary tables only.
- Cafe' Height, stationary tables only.
- Polished Aluminum
- Laser cut holes in base - 1.5" x 2.5"

- WL \$50 list per base
- CS \$20 list per base
- BH \$120 list per base
- CH \$120 list per base
- CR \$110 list per base
- WB \$55 list per table



NOTE: Nesting tables come standard on locking casters.  
The Beam nesting system is used for 84" long and 96" long tables

**FINISHES NEEDED:** <http://hi5furniture.com/finishes/>  
HPL Top: Hi5 Graded-in laminates or Non-Premium W A or Formica  
Edge Color: Any Hi5 standard  
Base Finish: Any Hi5 standard

HPL Top Self edges <b>Suffix L6</b>	HPL Top Wood edges <b>Suffix L20</b>	HPL Top Plywood edges <b>Suffix L17</b>	
HPL Top 3mm PVC <b>Suffix L3</b>	HPL Top Knife PVC <b>Suffix L11</b>	HPL Top Knife Wood <b>Suffix L33</b>	HPL Top Knife Plywood <b>Suffix L18</b>

Table Size	Top Shape	Table Function	Model Code:	Base Placement	List Price	List Price	List Price	Base QTY	Base Size	Base Style
48 x 120	any shape	folding	HRT2 4812029 ??F	Inset	\$3,020	\$3,770	\$4,800	2	35"	TT
48 x 120	any shape	stationary	HRT2 4812029 ??S	Inset	\$3,780	\$4,530	\$5,560	3	35"	TT
48 x 120	rectangle	folding	HRT2 4812029 REF	Inset	\$2,950	\$3,665	\$4,580	2	35"	TT
48 x 120	rectangle	stationary	HRT2 4812029 RES	Inset	\$3,710	\$4,425	\$5,340	3	35"	TT
48 x 132	any shape	stationary	HRT2 4813229 ??S	Inset	\$5,960	\$7,420	\$8,140	4	35"	TT
48 x 132	rectangle	stationary	HRT2 4813229 RES	Inset	\$5,610	\$6,895	\$7,990	4	35"	TT
48 x 144	any shape	stationary	HRT2 4814429 ??S	Inset	\$5,980	\$7,450	\$8,780	4	35"	TT
48 x 144	rectangle	stationary	HRT2 4814429 RES	Inset	\$5,680	\$7,000	\$8,380	4	35"	TT
48 x 168	any shape	stationary	HRT2 4816829 ??S	Inset	\$6,350	\$8,005	\$9,260	4	35"	TT
48 x 168	rectangle	stationary	HRT2 4816829 RES	Inset	\$6,040	\$7,540	\$8,860	4	35"	TT
48 x 192	any shape	stationary	HRT2 4819229 ??S	Inset	\$7,140	\$8,810	\$10,180	5	35"	TT
48 x 192	rectangle	stationary	HRT2 4819229 RES	Inset	\$6,830	\$8,345	\$9,780	5	35"	TT
48 x 216	any shape	stationary	HRT2 4821629 ??S	Inset	\$7,500	\$9,350	\$10,650	5	35"	TT
48 x 216	rectangle	stationary	HRT2 4821629 RES	Inset	\$7,190	\$8,885	\$10,260	5	35"	TT
48 x 240	any shape	stationary	HRT2 4824029 ??S	Inset	\$7,530	\$9,395	\$10,810	5	35"	TT
48 x 240	rectangle	stationary	HRT2 4824029 RES	Inset	\$7,220	\$8,930	\$10,410	5	35"	TT

POWER & A/V OPTIONS SEE PAGES 8-20

TABLE OPTIONS:

Hidden Wheels	WL	\$50 list per base
Locking Casters	CS	\$20 list per base
Bar Height, stationary tables only.	BH	\$120 list per base
Cafe' Height, stationary tables only.	CH	\$120 list per base
Polished Aluminum	CR	\$110 list per base
Laser cut holes in base - 1.5" x 2.5"	WB	\$55 list per table





NOTE: Nesting tables come standard on locking casters.  
The Beam nesting system is used for 84" long and 96" long tables

**FINISHES NEEDED:** <http://hi5furniture.com/finishes/>  
HPL Top: Hi5 Graded-in laminates or Non-Premium W A or Formica  
Edge Color: Any Hi5 standard  
Base Finish: Any Hi5 standard

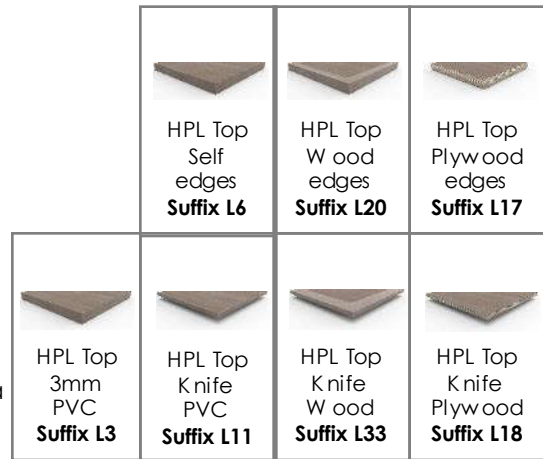

Table Size	Top Shape	Table Function	Model Code:	Base Placement	List Price	List Price	List Price	Base QTY	Base Size	Base Style
60 x 66	any shape	stationary	HRT2 606629 ??S	Inset	\$2,730	\$3,335	\$4,230	2	35"	TT
60 x 66	rectangle	stationary	HRT2 606629 RES	Inset	\$2,670	\$3,245	\$4,060	2	35"	TT
60 x 72	any shape	stationary	HRT2 607229 ??S	Inset	\$2,740	\$3,350	\$4,270	2	35"	TT
60 x 72	rectangle	stationary	HRT2 607229 RES	Inset	\$2,680	\$3,260	\$4,100	2	35"	TT
60 x 84	any shape	stationary	HRT2 608429 ??S	Inset	\$2,990	\$3,725	\$4,590	2	35"	TT
60 x 84	rectangle	stationary	HRT2 608429 RES	Inset	\$2,930	\$3,635	\$4,420	2	35"	TT
60 x 96	any shape	stationary	HRT2 609629 ??S	Inset	\$3,010	\$3,755	\$4,670	2	35"	TT
60 x 96	rectangle	stationary	HRT2 609629 RES	Inset	\$2,940	\$3,650	\$4,500	2	35"	TT
60 x 108	any shape	stationary	HRT2 6010829 ??S	Inset	\$4,020	\$4,890	\$5,740	3	35"	TT
60 x 108	rectangle	stationary	HRT2 6010829 RES	Inset	\$3,940	\$4,770	\$5,580	3	35"	TT
60 x 120	any shape	stationary	HRT2 6012029 ??S	Inset	\$4,030	\$4,905	\$5,830	3	35"	TT
60 x 120	rectangle	stationary	HRT2 6012029 RES	Inset	\$3,960	\$4,800	\$5,660	3	35"	TT
60 x 132	any shape	stationary	HRT2 6013229 ??S	Inset	\$6,390	\$8,065	\$9,090	4	35"	TT
60 x 132	rectangle	stationary	HRT2 6013229 RES	Inset	\$6,030	\$7,525	\$8,460	4	35"	TT
60 x 144	any shape	stationary	HRT2 6014429 ??S	Inset	\$6,410	\$8,095	\$9,250	4	35"	TT
60 x 144	rectangle	stationary	HRT2 6014429 RES	Inset	\$6,120	\$7,660	\$8,930	4	35"	TT
60 x 168	any shape	stationary	HRT2 6016829 ??S	Inset	\$6,860	\$8,770	\$9,810	4	35"	TT
60 x 168	rectangle	stationary	HRT2 6016829 RES	Inset	\$6,570	\$8,335	\$9,490	4	35"	TT
60 x 192	any shape	stationary	HRT2 6019229 ??S	Inset	\$7,650	\$9,575	\$10,730	5	35"	TT
60 x 192	rectangle	stationary	HRT2 6019229 RES	Inset	\$7,360	\$9,140	\$10,400	5	35"	TT
60 x 216	any shape	stationary	HRT2 6021629 ??S	Inset	\$8,100	\$10,250	\$11,290	5	35"	TT
60 x 216	rectangle	stationary	HRT2 6021629 RES	Inset	\$7,810	\$9,815	\$10,960	5	35"	TT
60 x 240	any shape	stationary	HRT2 6024029 ??S	Inset	\$8,130	\$10,295	\$11,440	5	35"	TT
60 x 240	rectangle	stationary	HRT2 6024029 RES	Inset	\$7,840	\$9,860	\$11,120	5	35"	TT

POWER & A/V OPTIONS SEE PAGES 8-20

TABLE OPTIONS:

- Hidden Wheels
- Locking Casters
- Bar Height, stationary tables only.
- Cafe' Height, stationary tables only.
- Polished Aluminum
- Laser cut holes in base - 1.5" x 2.5"

- WL \$50 list per base
- CS \$20 list per base
- BH \$120 list per base
- CH \$120 list per base
- CR \$110 list per base
- WB \$55 list per table

18 x 60

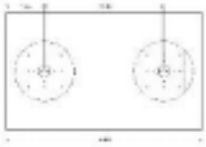

24 x 60

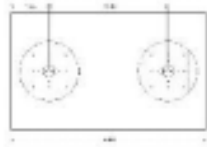

30 x 60

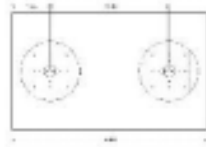

36 x 60

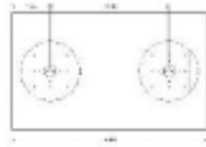

18 x 72

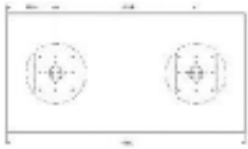

24 x 72

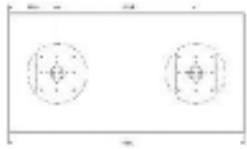

30 x 72

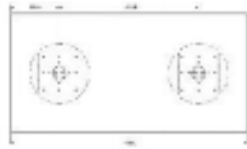

36 x 72

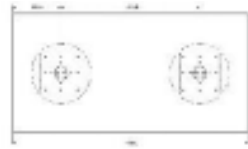

18 x 84

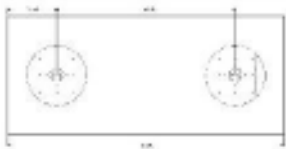

24 x 84

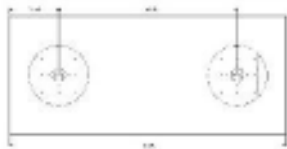

30 x 84

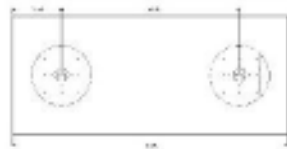

36 x 84

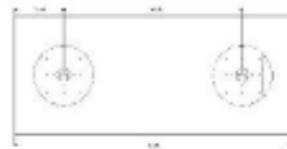

18 x 96

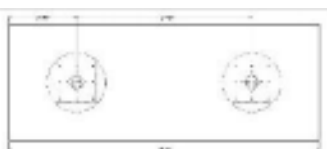

24 x 96

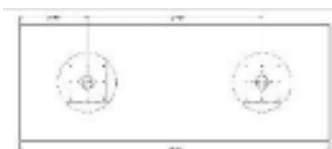

30 x 96



36 x 96

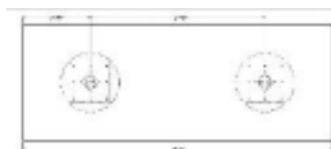

18 x 120



24 x 120

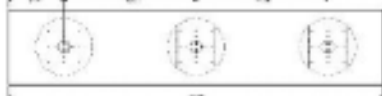

30 x 120



36 x 120





**FINISHES NEEDED:** <http://hi5furniture.com/finishes/>

HPL Top: Hi5 Graded-in laminates or Non-Premium Wilsonart or Formica  
Edge Color: Any Hi5 standard  
Base Finish: Any Hi5 standard

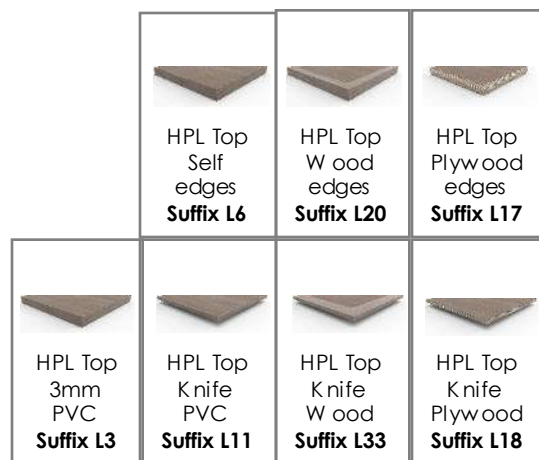

Table Size	Top Shape	Base Shape	Model Code:	Top QTY	Base QTY	Base Size	Column Size	List Price	List Price	List Price
24 x 29" H	ROUND	Round Base	IDD1 2429RDS	1	1	18"	4"	\$1,045	\$1,180	\$1,555
24 x 29" H	ROUND	Square Base	IDQ1 2429RDS	1	1	18"	4"	\$1,345	\$1,470	\$1,520
30 x 29" H	ROUND	Round Base	IDD1 3029RDS	1	1	18"	4"	\$1,090	\$1,275	\$1,740
30 x 29" H	ROUND	Square Base	IDQ1 3029RDS	1	1	18"	4"	\$1,415	\$1,550	\$1,755
36 x 29" H	ROUND	Round Base	IDD1 3629RDS	1	1	18"	4"	\$1,230	\$1,380	\$1,980
36 x 29" H	ROUND	Square Base	IDQ1 3629RDS	1	1	18"	4"	\$1,495	\$1,625	\$2,110
42 x 29" H	ROUND	Round Base	IDD1 4229RDS	1	1	24"	4"	\$1,530	\$1,620	\$2,410
42 x 29" H	ROUND	Square Base	IDQ1 4229RDS	1	1	24"	4"	\$1,670	\$1,810	\$2,800
48 x 29" H	ROUND	Round Base	IDD1 4829RDS	1	1	24"	4"	\$1,780	\$2,010	\$2,960
48 x 29" H	ROUND	Square Base	IDQ1 4829RDS	1	1	24"	6"	\$1,680	\$1,815	\$3,180
60 x 29" H	ROUND	Round Base	IDD1 6029RDS	1	1	32"	6"	\$2,525	\$2,675	\$4,960

POWER & A/V OPTIONS SEE PAGES 8-20

TABLE OPTIONS:

Add Levelers – Raises base 1" off of the floor	LV	\$80 per table
Bar Height on round bases (overall table height is 42")	BH	\$90 per table
Bar Height on square bases (overall table height is 42")	BH	\$150 per table
Café Height on round bases (overall table height is 36")	CH	\$90 per table
Café Height on square bases (overall table height is 36")	CH	\$150 per table
Alternate table height shorter than 29"	SC	\$90 per table
Alternate table height taller than 29"	TC	\$130 per table
Adjustable height (spring clip)	AH	\$280 per table
Polished Chrome on 18" and 24" round bases	CR	\$225 per table



**FINISHES NEEDED:** <http://hi5furniture.com/finishes/>

HPL Top: Hi5 Graded-in laminates or Non-Premium Wilsonart or Formica  
Edge Color: Any Hi5 standard  
Base Finish: Any Hi5 standard

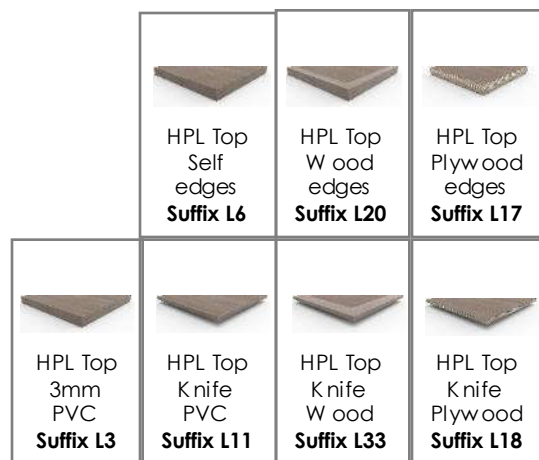

Table Size	Top Shape	Base Shape	Model Code:	Top QTY	Base QTY	Base Size	Column Size	List Price	List Price	List Price
24 x 24x 29" H	SQUARE	Round Base	IDD1 242429SQ S	1	1	18"	4"	\$960	\$1,090	\$1,440
24 x 24x 29" H	SQUARE	Square Base	IDQ1 242429SQ S	1	1	18"	4"	\$1,285	\$1,345	\$1,415
30 x 30x 29" H	SQUARE	Round Base	IDD1 303029SQ S	1	1	18"	4"	\$1,015	\$1,175	\$1,635
30 x 30x 29" H	SQUARE	Square Base	IDQ1 303029SQ S	1	1	18"	4"	\$1,355	\$1,420	\$1,680
36 x 36x 29" H	SQUARE	Round Base	IDD1 363629SQ S	1	1	24"	4"	\$1,260	\$1,410	\$2,005
36 x 36x 29" H	SQUARE	Square Base	IDQ1 363629SQ S	1	1	24"	4"	\$1,585	\$1,660	\$2,170
42 x 42x 29" H	SQUARE	Round Base	IDD1 424229SQ S	1	1	24"	4"	\$1,555	\$1,865	\$2,655
42 x 42x 29" H	SQUARE	Square Base	IDQ1 424229SQ S	1	1	24"	4"	\$1,610	\$1,695	\$2,690
48 x 48x 29" H	SQUARE	Round Base	IDD1 484829SQ S	1	1	28"	4"	\$1,620	\$1,910	\$2,850
48 x 48x 29" H	SQUARE	Square Base	IDQ1 484829SQ S	1	1	24"	6"	\$1,850	\$1,940	\$3,235

POWER & A/V OPTIONS SEE PAGES 8-20

TABLE OPTIONS:

Add Levelers – Raises base 1" off of the floor	LV	\$80 per table
Bar Height on round bases (overall table height is 42")	BH	\$90 per table
Bar Height on square bases (overall table height is 42")	BH	\$150 per table
Café Height on round bases (overall table height is 36")	CH	\$90 per table
Café Height on square bases (overall table height is 36")	CH	\$150 per table
Alternate table height shorter than 29"	SC	\$90 per table
Alternate table height taller than 29"	TC	\$130 per table
Adjustable height (spring clip)	AH	\$280 per table
Polished Chrome on 18" and 24" round bases	CR	\$225 per table



**FINISHES NEEDED:** <http://hi5furniture.com/finishes/>  
HPL Top: Hi5 Graded-in laminates or Non-Premium Wilsonart or Formica  
Edge Color: Any Hi5 standard  
Base Finish: Any Hi5 standard

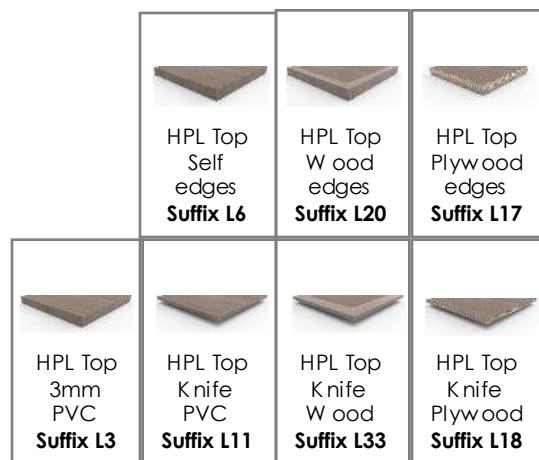

Table Size	Top Shape	Base Shape	Model Code:	Top QTY	Base QTY	Base Size	Column Size	List Price	List Price	List Price
18 x 48x 29" H Rectangle	Round Base	Round Base	IDD1 184829RES	1	2	18"	4"	\$1,820	\$1,940	\$2,140
18 x 48x 29" H Rectangle	Square Base	Square Base	IDQ1 184829RES	1	2	18"	4"	\$2,225	\$2,300	\$2,825
18 x 60x 29" H Rectangle	Round Base	Round Base	IDD1 186029RES	1	2	18"	4"	\$1,880	\$2,010	\$2,250
18 x 60x 29" H Rectangle	Square Base	Square Base	IDQ1 186029RES	1	2	18"	4"	\$2,310	\$2,390	\$3,060
18 x 72x 29" H Rectangle	Round Base	Round Base	IDD1 187229RES	1	2	18"	4"	\$1,925	\$2,075	\$2,365
18 x 72x 29" H Rectangle	Square Base	Square Base	IDQ1 187229RES	1	2	18"	4"	\$2,385	\$2,480	\$3,315
18 x 84x 29" H Rectangle	Round Base	Round Base	IDD1 188429RES	1	2	18"	4"	\$2,025	\$2,140	\$2,480
18 x 84x 29" H Rectangle	Square Base	Square Base	IDQ1 188429RES	1	2	18"	4"	\$2,425	\$2,525	\$3,780
18 x 96x 29" H Rectangle	Round Base	Round Base	IDD1 189629RES	1	2	18"	4"	\$2,040	\$2,210	\$2,725
18 x 96x 29" H Rectangle	Square Base	Square Base	IDQ1 189629RES	1	2	18"	4"	\$2,430	\$2,545	\$3,795
18 x 120x 29" H Rectangle	Round Base	Round Base	IDD1 1812029RES	1	2	18"	4"	\$2,345	\$2,480	\$4,040
18 x 120x 29" H Rectangle	Square Base	Square Base	IDQ1 1812029RES	1	2	18"	4"	\$2,565	\$2,700	\$4,260

POWER & A/V OPTIONS SEE PAGES 8-20

TABLE OPTIONS:

Add Levelers – Raises base 1" off of the floor	LV	\$80 per table
Bar Height on round bases (overall table height is 42")	BH	\$90 per table
Bar Height on square bases (overall table height is 42")	BH	\$150 per table
Café Height on round bases (overall table height is 36")	CH	\$90 per table
Café Height on square bases (overall table height is 36")	CH	\$150 per table
Alternate table height shorter than 29"	SC	\$90 per table
Alternate table height taller than 29"	TC	\$130 per table
Adjustable height (spring clip)	AH	\$280 per table
Polished Chrome on 18" and 24" round bases	CR	\$225 per table



**FINISHES NEEDED:** <http://hi5furniture.com/finishes/>

HPL Top: Hi5 Graded-in laminates or Non-Premium Wilsonart or Formica  
Edge Color: Any Hi5 standard  
Base Finish: Any Hi5 standard

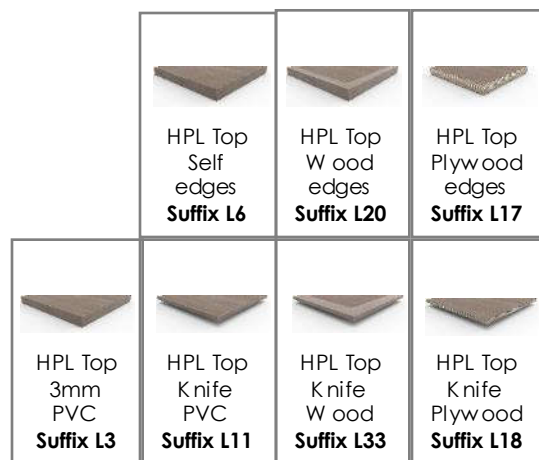

Table Size	Top Shape	Base Shape	Model Code:	Top QTY	Base QTY	Base Size	Column Size	List Price	List Price	List Price
24 x 30x 29" H Rectangle	Round Base	Round Base	IDD1 243029RES	1	1	18"	4"	\$985	\$1,125	\$1,390
24 x 30x 29" H Rectangle	Square Base	Square Base	IDQ1 243029RES	1	1	18"	4"	\$1,295	\$1,355	\$1,530
24 x 36x 29" H Rectangle	Round Base	Round Base	IDD1 243629RES	1	1	18"	4"	\$1,010	\$1,170	\$1,490
24 x 36x 29" H Rectangle	Square Base	Square Base	IDQ1 243629RES	1	1	18"	4"	\$1,305	\$1,365	\$1,650
24 x 42x 29" H Rectangle	Round Base	Round Base	IDD1 244229RES	1	1	24"	4"	\$1,170	\$1,350	\$1,735
24 x 42x 29" H Rectangle	Square Base	Square Base	IDQ1 244229RES	1	1	24"	4"	\$1,470	\$1,535	\$1,965
24 x 48x 29" H Rectangle	Round Base	Round Base	IDD1 244829RES	1	2	18"	4"	\$1,840	\$2,020	\$2,450
24 x 48x 29" H Rectangle	Square Base	Square Base	IDQ1 244829RES	1	2	18"	4"	\$2,250	\$2,325	\$2,825
24 x 60x 29" H Rectangle	Round Base	Round Base	IDD1 246029RES	1	2	18"	4"	\$1,890	\$2,100	\$2,630
24 x 60x 29" H Rectangle	Square Base	Square Base	IDQ1 246029RES	1	2	18"	4"	\$2,335	\$2,415	\$3,060
24 x 72x 29" H Rectangle	Round Base	Round Base	IDD1 247229RES	1	2	18"	4"	\$1,930	\$2,185	\$2,820
24 x 72x 29" H Rectangle	Square Base	Square Base	IDQ1 247229RES	1	2	18"	4"	\$2,410	\$2,505	\$3,315
24 x 84x 29" H Rectangle	Round Base	Round Base	IDD1 248429RES	1	2	18"	4"	\$2,035	\$2,265	\$3,015
24 x 84x 29" H Rectangle	Square Base	Square Base	IDQ1 248429RES	1	2	18"	4"	\$2,450	\$2,545	\$3,780
24 x 96x 29" H Rectangle	Round Base	Round Base	IDD1 249629RES	1	2	18"	4"	\$2,045	\$2,355	\$3,195
24 x 96x 29" H Rectangle	Square Base	Square Base	IDQ1 249629RES	1	2	18"	4"	\$2,455	\$2,570	\$3,795
24 x 120x 29" H Rectangle	Round Base	Round Base	IDD1 2412029RES	1	2	18"	4"	\$2,370	\$2,505	\$4,040
24 x 120x 29" H Rectangle	Square Base	Square Base	IDQ1 2412029RES	1	2	18"	4"	\$2,590	\$2,725	\$4,260

POWER & A/V OPTIONS SEE PAGES 8-20

TABLE OPTIONS:

Add Levelers – Raises base 1" off of the floor	LV	\$80 per table
Bar Height on round bases (overall table height is 42")	BH	\$90 per table
Bar Height on square bases (overall table height is 42")	BH	\$150 per table
Café Height on round bases (overall table height is 36")	CH	\$90 per table
Café Height on square bases (overall table height is 36")	CH	\$150 per table
Alternate table height shorter than 29"	SC	\$90 per table
Alternate table height taller than 29"	TC	\$130 per table
Adjustable height (spring clip)	AH	\$280 per table
Polished Chrome on 18" and 24" round bases	CR	\$225 per table



**FINISHES NEEDED:** <http://hi5furniture.com/finishes/>

HPL Top: Hi5 Graded-in laminates or Non-Premium Wilsonart or Formica  
Edge Color: Any Hi5 standard  
Base Finish: Any Hi5 standard

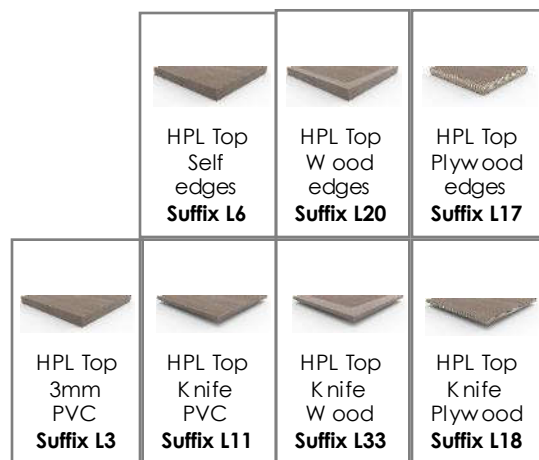
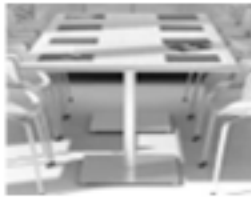

Table Size	Top Shape	Base Shape	Model Code:	Top QTY	Base QTY	Base Size	Column Size	List Price	List Price	List Price
30 x 36x 29" H Rectangle	Rectangle	Round Base	IDD1 303629RES	1	1	24"	4	\$1,350	\$1,415	\$1,870
30 x 36x 29" H Rectangle	Rectangle	Square Base	IDQ1 303629RES	1	1	18"	4	\$1,315	\$1,380	\$1,835
30 x 48x 29" H Rectangle	Rectangle	Round Base	IDD1 304829RES	1	1	24"	4	\$1,235	\$1,445	\$2,085
30 x 48x 29" H Rectangle	Rectangle	Square Base	IDQ1 304829RES	1	1	18"	4	\$1,390	\$1,470	\$2,130
30 x 60x 29" H Rectangle	Rectangle	Round Base	IDD1 306029RES	1	2	18"	4	\$1,930	\$2,190	\$3,060
30 x 60x 29" H Rectangle	Rectangle	Square Base	IDQ1 306029RES	1	2	18"	4	\$2,420	\$2,510	\$3,365
30 x 72x 29" H Rectangle	Rectangle	Round Base	IDD1 307229RES	1	2	18"	4	\$1,985	\$2,300	\$3,275
30 x 72x 29" H Rectangle	Rectangle	Square Base	IDQ1 307229RES	1	2	18"	4	\$2,515	\$2,620	\$3,680
30 x 84x 29" H Rectangle	Rectangle	Round Base	IDD1 308429RES	1	2	18"	4	\$2,105	\$2,395	\$3,480
30 x 84x 29" H Rectangle	Rectangle	Square Base	IDQ1 308429RES	1	2	18"	4	\$2,545	\$2,655	\$4,260
30 x 96x 29" H Rectangle	Rectangle	Round Base	IDD1 309629RES	1	2	18"	4	\$2,120	\$2,500	\$3,690
30 x 96x 29" H Rectangle	Rectangle	Square Base	IDQ1 309629RES	1	2	18"	4	\$2,560	\$2,680	\$4,285
30 x 120x 29" H Rectangle	Rectangle	Round Base	IDD1 3012029RES	1	2	18"	4	\$2,495	\$2,640	\$4,670
30 x 120x 29" H Rectangle	Rectangle	Square Base	IDQ1 3012029RES	1	2	18"	4	\$2,710	\$2,855	\$4,890

POWER & A/V OPTIONS SEE PAGES 8-20

TABLE OPTIONS:

Add Levelers – Raises base 1" off of the floor	LV	\$80 per table
Bar Height on round bases (overall table height is 42")	BH	\$90 per table
Bar Height on square bases (overall table height is 42")	BH	\$150 per table
Café Height on round bases (overall table height is 36")	CH	\$90 per table
Café Height on square bases (overall table height is 36")	CH	\$150 per table
Alternate table height shorter than 29"	SC	\$90 per table
Alternate table height taller than 29"	TC	\$130 per table
Adjustable height (spring clip)	AH	\$280 per table
Polished Chrome on 18" and 24" round bases	CR	\$225 per table



**FINISHES NEEDED:** <http://hi5furniture.com/finishes/>

HPL Top: Hi5 Graded-in laminates or Non-Premium Wilsonart or Formica  
Edge Color: Any Hi5 standard  
Base Finish: Any Hi5 standard

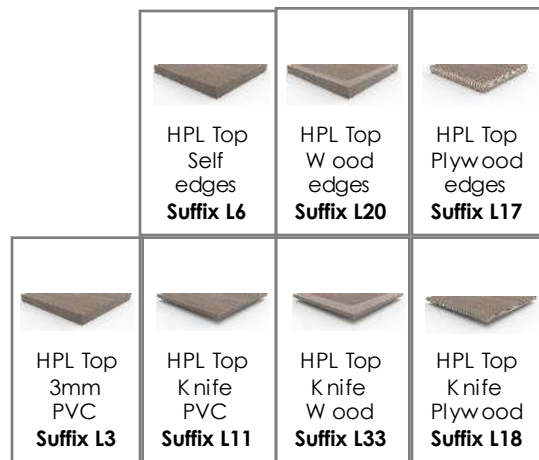

Table Size	Top Shape	Base Shape	Model Code:	Top QTY	Base QTY	Base Size	Column Size	List Price	List Price	List Price
36 x 48x 29" H Rectangle	Rectangle	Round Base	IDD1 364829RES	1	1	28"	4	\$1,590	\$1,760	\$2,530
36 x 48x 29" H Rectangle	Rectangle	Square Base	IDQ1 364829RES	1	1	18"x28"	6	\$1,825	\$1,910	\$2,715
36 x 60x 29" H Rectangle	Rectangle	Round Base	IDD1 366029RES	1	2	18"	4	\$2,325	\$2,530	\$3,540
36 x 60x 29" H Rectangle	Rectangle	Square Base	IDQ1 366029RES	1	2	18"	4	\$2,530	\$2,625	\$3,660
36 x 72x 29" H Rectangle	Rectangle	Round Base	IDD1 367229RES	1	2	18"	4	\$2,410	\$2,650	\$3,795
36 x 72x 29" H Rectangle	Rectangle	Square Base	IDQ1 367229RES	1	2	18"	4	\$2,640	\$2,755	\$4,035
36 x 84x 29" H Rectangle	Rectangle	Round Base	IDD1 368429RES	1	2	18"	4	\$2,590	\$2,765	\$4,520
36 x 84x 29" H Rectangle	Rectangle	Square Base	IDQ1 368429RES	1	2	18"	4	\$2,890	\$3,045	\$4,735
36 x 96x 29" H Rectangle	Rectangle	Round Base	IDD1 369629RES	1	2	18"	4	\$2,610	\$2,885	\$4,290
36 x 96x 29" H Rectangle	Rectangle	Square Base	IDQ1 369629RES	1	2	18"	4	\$2,905	\$3,060	\$4,765
36 x 120x 29" H Rectangle	Rectangle	Round Base	IDD1 3612029RES	1	2	18"	4	\$2,910	\$3,105	\$5,295
36 x 120x 29" H Rectangle	Rectangle	Square Base	IDQ1 3612029RES	1	2	18"	4	\$3,130	\$3,320	\$5,510

POWER & A/V OPTIONS SEE PAGES 8-20

TABLE OPTIONS:

Add Levelers – Raises base 1" off of the floor	LV	\$80 per table
Bar Height on round bases (overall table height is 42")	BH	\$90 per table
Bar Height on square bases (overall table height is 42")	BH	\$150 per table
Café Height on round bases (overall table height is 36")	CH	\$90 per table
Café Height on square bases (overall table height is 36")	CH	\$150 per table
Alternate table height shorter than 29"	SC	\$90 per table
Alternate table height taller than 29"	TC	\$130 per table
Adjustable height (spring clip)	AH	\$280 per table
Polished Chrome on 18" and 24" round bases	CR	\$225 per table



# Lincoln Model Choices

www.hi5furniture.com Questions? 816-774-4050

March 1, 2018



**Code: LNUC**  
U / Post Combo



**Code: LNUT**  
U Bases



**Code: LNUM**  
Inset U / Post Combo

## SEATED HEIGHT

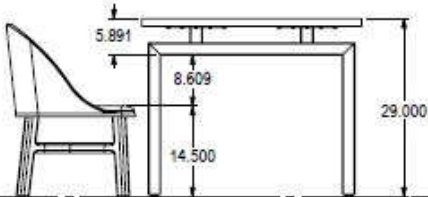

## CAFE HEIGHT

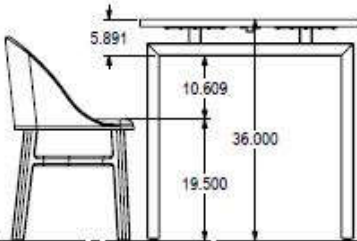

## BAR HEIGHT

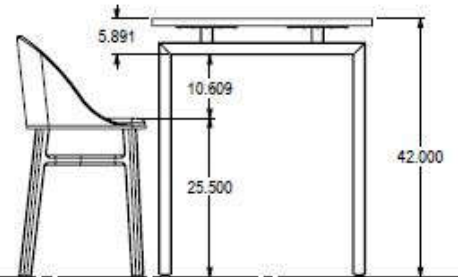



# Lincoln Base Placement 24" & 30" Deep

www.hi5furniture.com Questions? 816-774-4050

March 1, 2018

U/Post Combo  
Code: LNUC

U Bases Only  
Code: LNUJ

Inset U/Post Combo  
Code: LNUM

42" Long

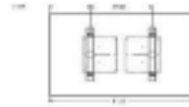
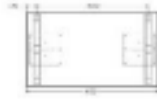

48" Long

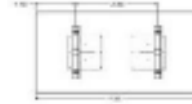

60" Long

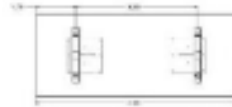

66" Long

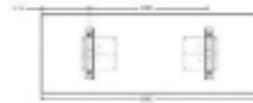

72" Long



84" Long

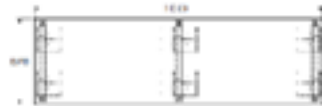

96" Long



108" Long

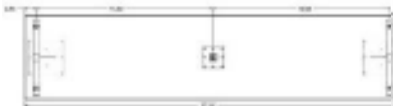

120" Long

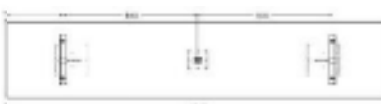
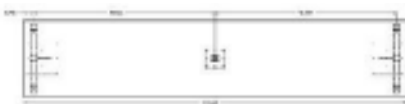

144" Long

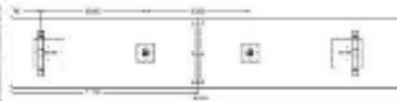
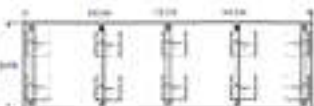

168" long

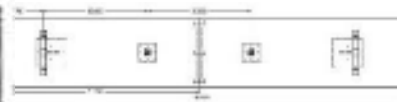
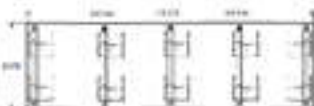

# Lincoln Base Placement 36" & 42" Deep

www.hi5furniture.com Questions? 816-774-4050

March 1, 2018

U/Post Combo  
Code: LNUC

U Bases Only  
Code: LNUY

Inset U/Post Combo  
Code: LNUM

48" Long

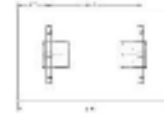
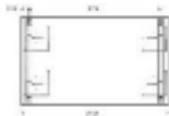

60" Long

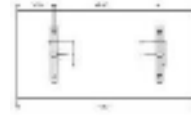

66" Long

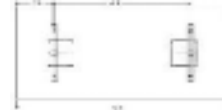

72" Long

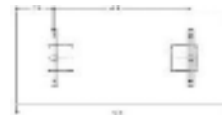

84" Long

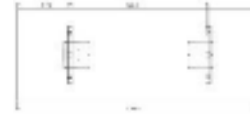
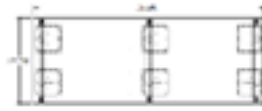
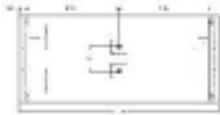

96" Long

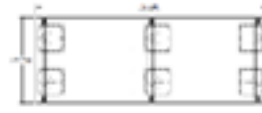

108" Long

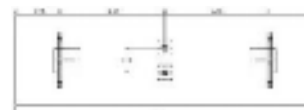
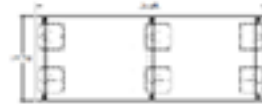
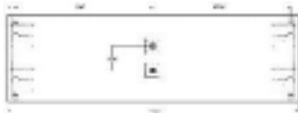

120" Long

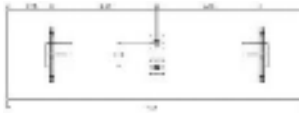
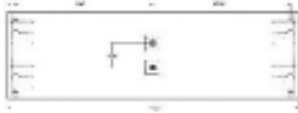

144" Long

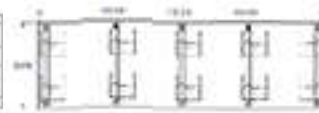
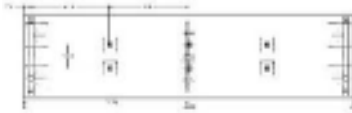

168" Long

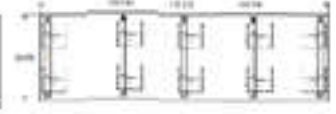
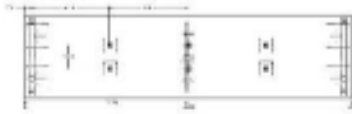

192" Long

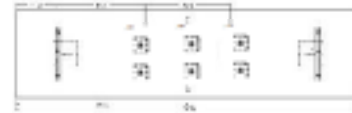
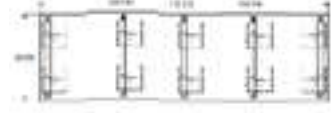
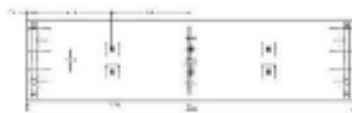

216" Long

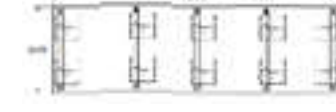

240" Long

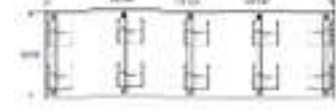
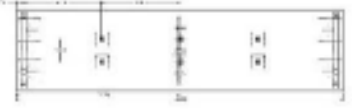

# Lincoln Base Placement 48" & 60" Deep

www.hi5furniture.com Questions? 816-774-4050

March 1, 2018

U/Post Combo  
Code: LNUC

U Bases Only  
Code: LNUY

Inset U/Post Combo  
Code: LNUM

72" Long

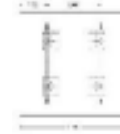
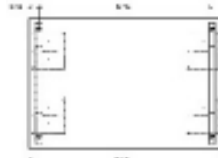

84" Long

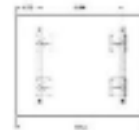
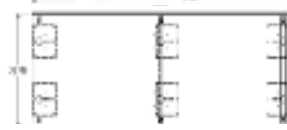

96" Long



108" Long

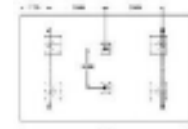
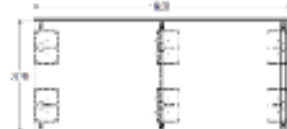

120" Long

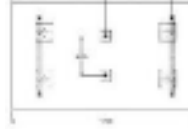
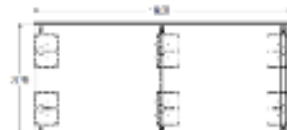
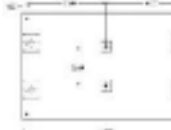

144" Long

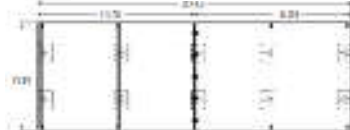

168" Long

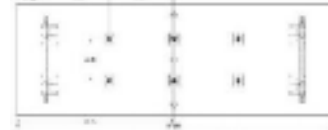
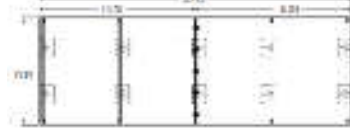
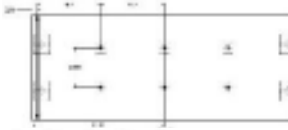

192" Long

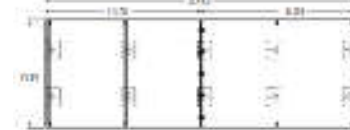
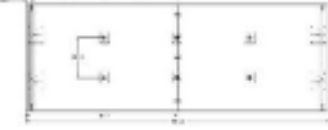

216" Long

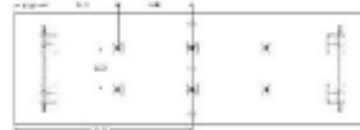
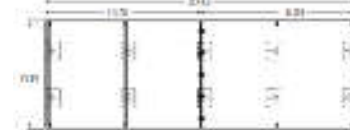
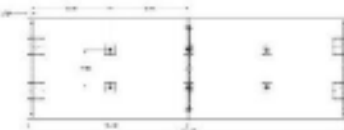

240" Long





**FINISHES NEEDED:** <http://hi5furniture.com/finishes/>

HPL Top: Hi5 Graded-in laminates or Non-Premium Wilsonart or Formica

Edge Color: Any Hi5 standard

Base Finish: Any Hi5 standard

Table Size	Base Style	Model Code:	# Top Pieces	# of Posts	# of Squares	List Price	List Price	List Price
36 x 36x 29" H	U Bases	LNUT364229SQS	1	0	2-36"	\$2,910	\$3,065	\$3,720
36 x 36x 36" H	U Bases	LNUT364236SQS	1	0	2-36"	\$3,030	\$3,185	\$3,840
36 x 36x 42" H	U Bases	LNUT364242SQS	1	0	2-36"	\$3,150	\$3,305	\$3,960
42 x 42x 29" H	U Bases	LNUT364229SQS	1	0	2-42"	\$3,210	\$3,420	\$4,080
42 x 42x 36" H	U Bases	LNUT364236SQS	1	0	2-42"	\$3,330	\$3,540	\$4,200
42 x 42x 42" H	U Bases	LNUT364242SQS	1	0	2-42"	\$3,450	\$3,660	\$4,320
48 x 48x 29" H	U Bases	LNUT364229SQS	1	0	2-48"	\$3,340	\$3,550	\$4,290
48 x 48x 36" H	U Bases	LNUT364236SQS	1	0	2-48"	\$3,460	\$3,670	\$4,410
48 x 48x 42" H	U Bases	LNUT364242SQS	1	0	2-48"	\$3,580	\$3,790	\$4,530
60 x 60x 29" H	U Bases	LNUT364229SQS	1	0	2-60"	\$3,790	\$4,305	\$5,140
60 x 60x 36" H	U Bases	LNUT364236SQS	1	0	2-60"	\$3,910	\$4,425	\$5,260
60 x 60x 42" H	U Bases	LNUT364242SQS	1	0	2-60"	\$4,030	\$4,545	\$5,380

POWER & A/V OPTIONS SEE PAGES 8-20

TABLE OPTIONS:

Laser cut holes in base - 1.5" x 2.5"

Industrial Locking Casters

WB

CS

\$100 list per table

\$70 list per caster



**FINISHES NEEDED:** <http://hi5furniture.com/finishes/>

HPL Top: Hi5 Graded-in laminates or Non-Premium Wilsonart or Formica

Edge Color: Any Hi5 standard

Base Finish: Any Hi5 standard







			
HPL Top Self edges <b>Suffix L6</b>	HPL Top Wood edges <b>Suffix L20</b>	HPL Top Plywood edges <b>Suffix L17</b>	
			
HPL Top 3mm PVC <b>Suffix L3</b>	HPL Top Knife PVC <b>Suffix L11</b>	HPL Top Knife Wood <b>Suffix L33</b>	HPL Top Knife Plywood <b>Suffix L18</b>

Table Size	Base Style	Model Code:	# Top Pieces	# of Posts	# of U Bases	List Price	List Price	List Price
18 x 42x 29" H	U Bases	LNUT 184229RES	1	0	2-18"	\$2,360	\$2,495	\$3,100
18 x 42x 36" H	U Bases	LNUT 184236RES	1	0	2-18"	\$2,540	\$2,675	\$3,280
18 x 42x 42" H	U Bases	LNUT 184182RES	1	0	2-18"	\$2,720	\$2,855	\$3,460
18 x 48x 29" H	U Bases	LNUT 184829RES	1	0	2-18"	\$2,360	\$2,495	\$3,150
18 x 48x 36" H	U Bases	LNUT 184836RES	1	0	2-18"	\$2,540	\$2,675	\$3,330
18 x 48x 42" H	U Bases	LNUT 184842RES	1	0	2-18"	\$2,720	\$2,855	\$3,510
18 x 60x 29" H	U Bases	LNUT 186029RES	1	0	2-18"	\$2,410	\$2,560	\$3,110
18 x 60x 36" H	U Bases	LNUT 186036RES	1	0	2-18"	\$2,590	\$2,740	\$3,290
18 x 60x 42" H	U Bases	LNUT 186042RES	1	0	2-18"	\$2,770	\$2,920	\$3,470
18 x 66x 29" H	U Bases	LNUT 186629RES	1	0	2-18"	\$2,460	\$2,625	\$3,350
18 x 66x 36" H	U Bases	LNUT 186636RES	1	0	2-18"	\$2,640	\$2,805	\$3,530
18 x 66x 42" H	U Bases	LNUT 186642RES	1	0	2-18"	\$2,820	\$2,985	\$3,710
18 x 72x 29" H	U Bases	LNUT 187229RES	1	0	2-18"	\$2,670	\$2,860	\$3,340
18 x 72x 36" H	U Bases	LNUT 187236RES	1	0	2-18"	\$2,850	\$3,040	\$3,520
18 x 72x 42" H	U Bases	LNUT 187182RES	1	0	2-18"	\$3,030	\$3,220	\$3,700
18 x 84x 29" H	U   Post Combo	LNUC 188429RES	1	1	2-18"	\$2,975	\$3,195	\$4,235
18 x 84x 29" H	U Bases	LNUT 188429RES	1	0	3-18"	\$3,610	\$3,830	\$4,870
18 x 84x 36" H	U   Post Combo	LNUC 188436RES	1	1	2-18"	\$3,165	\$3,385	\$4,425
18 x 84x 36" H	U Bases	LNUT 188436RES	1	0	3-18"	\$3,880	\$4,100	\$5,140
18 x 84x 42" H	U   Post Combo	LNUC 188442RES	1	1	2-18"	\$3,355	\$3,575	\$4,615
18 x 84x 42" H	U Bases	LNUT 188442RES	1	0	3-18"	\$4,150	\$4,370	\$5,410

POWER & A/V OPTIONS SEE PAGES 8-20

TABLE OPTIONS:

Laser cut holes in base - 1.5" x 2.5"

Industrial Locking Casters

WB

\$100 list per table

CS

\$70 list per caster



**FINISHES NEEDED:** <http://hi5furniture.com/finishes/>  
 HPL Top: Hi5 Graded-in laminates or Non-Premium Wilsonart or Formica  
 Edge Color: Any Hi5 standard  
 Base Finish: Any Hi5 standard

Table Size	Base Style	Model Code:	# Top Pieces	# of Posts	# of U Bases	List Price	List Price	List Price
18 x 96x 29" H	U   Post Combo	LNUC 189629RES	1	1	2-18"	\$2,995	\$3,220	\$4,325
18 x 96x 29" H	U Bases	LNUT 189629RES	1	0	3-18"	\$3,630	\$3,855	\$4,960
18 x 96x 36" H	U   Post Combo	LNUC 189636RES	1	1	2-18"	\$3,185	\$3,410	\$4,515
18 x 96x 36" H	U Bases	LNUT 189636RES	1	0	3-18"	\$3,900	\$4,125	\$5,230
18 x 96x 42" H	U   Post Combo	LNUC 189642RES	1	1	2-18"	\$3,375	\$3,600	\$4,705
18 x 96x 42" H	U Bases	LNUT 189642RES	1	0	3-18"	\$4,170	\$4,395	\$5,500
18 x 108x 29" H	U   Post Combo	LNUC 1810829RES	1	1	2-18"	\$3,135	\$3,580	\$4,475
18 x 108x 29" H	U Bases	LNUT 1810829RES	1	0	3-18"	\$3,770	\$4,215	\$5,110
18 x 108x 36" H	U   Post Combo	LNUC 1810836RES	1	1	2-18"	\$3,325	\$3,770	\$4,665
18 x 108x 36" H	U Bases	LNUT 1810836RES	1	0	3-18"	\$4,040	\$4,485	\$5,380
18 x 108x 42" H	U   Post Combo	LNUC 1810842RES	1	1	2-18"	\$3,515	\$3,960	\$4,855
18 x 108x 42" H	U Bases	LNUT 1810842RES	1	0	3-18"	\$4,310	\$4,755	\$5,650
18 x 120x 29" H	U   Post Combo	LNUC 1812029RES	1	1	2-18"	\$3,155	\$3,610	\$4,565
18 x 120x 29" H	U Bases	LNUT 1812029RES	1	0	3-18"	\$3,790	\$4,245	\$5,200
18 x 120x 36" H	U   Post Combo	LNUC 1812036RES	1	1	2-18"	\$3,345	\$3,800	\$4,755
18 x 120x 36" H	U Bases	LNUT 1812036RES	1	0	3-18"	\$4,060	\$4,515	\$5,470
18 x 120x 42" H	U   Post Combo	LNUC 1812042RES	1	1	2-18"	\$3,535	\$3,990	\$4,945
18 x 120x 42" H	U Bases	LNUT 1812042RES	1	0	3-18"	\$4,330	\$4,785	\$5,740
18 x 144x 29" H	U   Post Combo	LNUC 1814429RES	2	3	2-18"	\$4,735	\$5,655	\$7,135
18 x 144x 29" H	U Bases	LNUT 1814429RES	2	0	4-18"	\$5,680	\$6,600	\$8,080
18 x 144x 36" H	U   Post Combo	LNUC 1814436RES	2	3	2-18"	\$4,945	\$5,865	\$7,345
18 x 144x 36" H	U Bases	LNUT 1814436RES	2	0	4-18"	\$6,040	\$6,960	\$8,440
18 x 144x 42" H	U   Post Combo	LNUC 1814442RES	2	3	2-18"	\$5,155	\$6,075	\$7,555
18 x 144x 42" H	U Bases	LNUT 1814442RES	2	0	4-18"	\$6,400	\$7,320	\$8,800

POWER & A/V OPTIONS SEE PAGES 8-20

TABLE OPTIONS:

Laser cut holes in base - 1.5" x 2.5"  
 Industrial Locking Casters

WB \$100 list per table  
 CS \$70 list per caster



Code: LNUC  
U / Post Combo



Code: LNUT  
U Bases



Code: LNUM  
Inset U / Post Combo

**FINISHES NEEDED:** <http://hi5furniture.com/finishes/>

HPL Top: Hi5 Graded-in laminates or Non-Premium Wilsonart or Formica

Edge Color: Any Hi5 standard

Base Finish: Any Hi5 standard

HPL Top Self edges <b>Suffix L6</b>	HPL Top Wood edges <b>Suffix L20</b>	HPL Top Plywood edges <b>Suffix L17</b>	
HPL Top 3mm PVC <b>Suffix L3</b>	HPL Top Knife PVC <b>Suffix L11</b>	HPL Top Knife Wood <b>Suffix L33</b>	HPL Top Knife Plywood <b>Suffix L18</b>

Table Size	Base Style	Model Code:	# Top Pieces	# of Posts	# of U Bases	List Price	List Price	List Price
24 x 42x 29" H	Inset U	LNUM 244229RES	1	0	2-18"	\$2,390	\$2,535	\$3,170
24 x 42x 29" H	U Bases	LNUT244229RES	1	0	2-24"	\$2,510	\$2,655	\$3,290
24 x 42x 36" H	Inset U	LNUM 244236RES	1	0	2-18"	\$2,570	\$2,715	\$3,350
24 x 42x 36" H	U Bases	LNUT244236RES	1	0	2-24"	\$2,690	\$2,835	\$3,470
24 x 42x 42" H	Inset U	LNUM 244242RES	1	0	2-18"	\$2,750	\$2,895	\$3,530
24 x 42x 42" H	U Bases	LNUT244242RES	1	0	2-24"	\$2,870	\$3,015	\$3,650
24 x 48x 29" H	Inset U	LNUM 244829RES	1	0	2-18"	\$2,400	\$2,545	\$3,220
24 x 48x 29" H	U Bases	LNUT244829RES	1	0	2-24"	\$2,520	\$2,665	\$3,340
24 x 48x 36" H	Inset U	LNUM 244836RES	1	0	2-18"	\$2,580	\$2,725	\$3,400
24 x 48x 36" H	U Bases	LNUT244836RES	1	0	2-24"	\$2,700	\$2,845	\$3,520
24 x 48x 42" H	Inset U	LNUM 244842RES	1	0	2-18"	\$2,760	\$2,905	\$3,580
24 x 48x 42" H	U Bases	LNUT244842RES	1	0	2-24"	\$2,880	\$3,025	\$3,700
24 x 60x 29" H	Inset U	LNUM 246029RES	1	0	2-18"	\$2,450	\$2,610	\$3,180
24 x 60x 29" H	U Bases	LNUT246029RES	1	0	2-24"	\$2,570	\$2,730	\$3,300
24 x 60x 36" H	Inset U	LNUM 246036RES	1	0	2-18"	\$2,630	\$2,790	\$3,360
24 x 60x 36" H	U Bases	LNUT246036RES	1	0	2-24"	\$2,750	\$2,910	\$3,480
24 x 60x 42" H	Inset U	LNUM 246042RES	1	0	2-18"	\$2,810	\$2,970	\$3,540
24 x 60x 42" H	U Bases	LNUT246042RES	1	0	2-24"	\$2,930	\$3,090	\$3,660
24 x 66x 29" H	Inset U	LNUM 246629RES	1	0	2-18"	\$2,520	\$2,700	\$3,430
24 x 66x 29" H	U Bases	LNUT246629RES	1	0	2-24"	\$2,760	\$2,940	\$3,670
24 x 66x 36" H	Inset U	LNUM 246636RES	1	0	2-18"	\$2,700	\$2,880	\$3,610
24 x 66x 36" H	U Bases	LNUT246636RES	1	0	2-24"	\$2,940	\$3,120	\$3,850
24 x 66x 42" H	Inset U	LNUM 246642RES	1	0	2-18"	\$2,880	\$3,060	\$3,790
24 x 66x 42" H	U Bases	LNUT246642RES	1	0	2-24"	\$3,120	\$3,300	\$4,030

POWER & A/V OPTIONS SEE PAGES 8-20

TABLE OPTIONS:

Laser cut holes in base - 1.5" x 2.5"

Industrial Locking Casters

WB

\$100 list per table

CS

\$70 list per caster





**FINISHES NEEDED:** <http://hi5furniture.com/finishes/>

HPL Top: Hi5 Graded-in laminates or Non-Premium Wilsonart or Formica

Edge Color: Any Hi5 standard

Base Finish: Any Hi5 standard

Table Size	Base Style	Model Code:	# Top Pieces	# of Posts	# of U Bases	List Price	List Price	List Price
24 x 72x 29" H	Inset U	LNUM 247229RES	1	0	2-18"	\$2,620	\$2,830	\$3,310
24 x 72x 29" H	U Bases	LNUT247229RES	1	0	2-24"	\$2,860	\$3,070	\$3,550
24 x 72x 36" H	Inset U	LNUM 247236RES	1	0	2-18"	\$2,800	\$3,010	\$3,490
24 x 72x 36" H	U Bases	LNUT247236RES	1	0	2-24"	\$3,040	\$3,250	\$3,730
24 x 72x 42" H	Inset U	LNUM 247242RES	1	0	2-18"	\$2,980	\$3,190	\$3,670
24 x 72x 42" H	U Bases	LNUT247242RES	1	0	2-24"	\$3,220	\$3,430	\$3,910
24 x 84x 29" H	U   Post Combo	LNUC 248429RES	1	1	2-24"	\$3,165	\$3,405	\$4,465
24 x 84x 29" H	Inset U	LNUM 248429RES	1	0	2-18"	\$2,720	\$2,960	\$4,020
24 x 84x 29" H	U Bases	LNUT248429RES	1	0	3-24"	\$3,860	\$4,100	\$5,160
24 x 84x 36" H	U   Post Combo	LNUC 248436RES	1	1	2-24"	\$3,355	\$3,595	\$4,655
24 x 84x 36" H	Inset U	LNUM 248436RES	1	0	2-18"	\$2,900	\$3,140	\$4,200
24 x 84x 36" H	U Bases	LNUT248436RES	1	0	3-24"	\$4,130	\$4,370	\$5,430
24 x 84x 42" H	U   Post Combo	LNUC 248442RES	1	1	2-24"	\$3,545	\$3,785	\$4,845
24 x 84x 42" H	Inset U	LNUM 248442RES	1	0	2-18"	\$3,080	\$3,320	\$4,380
24 x 84x 42" H	U Bases	LNUT248442RES	1	0	3-24"	\$4,400	\$4,640	\$5,700
24 x 96x 29" H	U   Post Combo	LNUC 249629RES	1	1	2-24"	\$3,175	\$3,420	\$4,545
24 x 96x 29" H	Inset U	LNUM 249629RES	1	0	2-18"	\$2,730	\$2,975	\$4,100
24 x 96x 29" H	U Bases	LNUT249629RES	1	0	3-24"	\$3,870	\$4,115	\$5,240
24 x 96x 36" H	U   Post Combo	LNUC 249636RES	1	1	2-24"	\$3,365	\$3,610	\$4,735
24 x 96x 36" H	Inset U	LNUM 249636RES	1	0	2-18"	\$2,910	\$3,155	\$4,280
24 x 96x 36" H	U Bases	LNUT249636RES	1	0	3-24"	\$4,140	\$4,385	\$5,510
24 x 96x 42" H	U   Post Combo	LNUC 249642RES	1	1	2-24"	\$3,555	\$3,800	\$4,925
24 x 96x 42" H	Inset U	LNUM 249642RES	1	0	2-18"	\$3,090	\$3,335	\$4,460
24 x 96x 42" H	U Bases	LNUT249642RES	1	0	3-24"	\$4,410	\$4,655	\$5,780

POWER & A/V OPTIONS SEE PAGES 8-20

TABLE OPTIONS:

Laser cut holes in base - 1.5" x 2.5"

Industrial Locking Casters

WB

\$100 list per table

CS

\$70 list per caster



**FINISHES NEEDED:** <http://hi5furniture.com/finishes/>  
 HPL Top: Hi5 Graded-in laminates or Non-Premium Wilsonart or Formica  
 Edge Color: Any Hi5 standard  
 Base Finish: Any Hi5 standard

Table Size	Base Style	Model Code:	# Top Pieces	# of Posts	# of U Bases	List Price	List Price	List Price
24 x 108x 29" H	U   Post Combo	LNUC 2410829RES	1	1	2-24"	\$3,285	\$3,745	\$4,715
24 x 108x 29" H	Inset Combo	LNUM 2410829RES	1	1	2-18"	\$3,165	\$3,625	\$4,595
24 x 108x 29" H	U Bases	LNUT 2410829RES	1	0	3-24"	\$3,980	\$4,440	\$5,410
24 x 108x 36" H	U   Post Combo	LNUC 2410836RES	1	1	2-24"	\$3,475	\$3,935	\$4,905
24 x 108x 36" H	Inset Combo	LNUM 2410836RES	1	1	2-18"	\$3,355	\$3,815	\$4,785
24 x 108x 36" H	U Bases	LNUT 2410836RES	1	0	3-24"	\$4,250	\$4,710	\$5,680
24 x 108x 42" H	U   Post Combo	LNUC 2410842RES	1	1	2-24"	\$3,665	\$4,125	\$5,095
24 x 108x 42" H	Inset Combo	LNUM 2410842RES	1	1	2-18"	\$3,545	\$4,005	\$4,975
24 x 108x 42" H	U Bases	LNUT 2410842RES	1	0	3-24"	\$4,520	\$4,980	\$5,950
24 x 120x 29" H	U   Post Combo	LNUC 2412029RES	1	1	2-24"	\$3,305	\$3,775	\$4,795
24 x 120x 29" H	Inset Combo	LNUM 2412029RES	1	1	2-18"	\$3,185	\$3,655	\$4,675
24 x 120x 29" H	U Bases	LNUT 2412029RES	1	0	3-24"	\$4,000	\$4,470	\$5,490
24 x 120x 36" H	U   Post Combo	LNUC 2412036RES	1	1	2-24"	\$3,495	\$3,965	\$4,985
24 x 120x 36" H	Inset Combo	LNUM 2412036RES	1	1	2-18"	\$3,375	\$3,845	\$4,865
24 x 120x 36" H	U Bases	LNUT 2412036RES	1	0	3-24"	\$4,270	\$4,740	\$5,760
24 x 120x 42" H	U   Post Combo	LNUC 2412042RES	1	1	2-24"	\$3,685	\$4,155	\$5,175
24 x 120x 42" H	Inset Combo	LNUM 2412042RES	1	1	2-18"	\$3,565	\$4,035	\$5,055
24 x 120x 42" H	U Bases	LNUT 2412042RES	1	0	3-24"	\$4,540	\$5,010	\$6,030
24 x 144x 29" H	U   Post Combo	LNUC 2414429RES	2	3	2-24"	\$4,955	\$5,925	\$7,365
24 x 144x 29" H	Inset Combo	LNUM 2414429RES	2	2	2-18"	\$4,510	\$5,480	\$6,920
24 x 144x 29" H	U Bases	LNUT 2414429RES	2	0	4-24"	\$6,020	\$6,990	\$8,430
24 x 144x 36" H	U   Post Combo	LNUC 2414436RES	2	3	2-24"	\$5,165	\$6,135	\$7,575
24 x 144x 36" H	Inset Combo	LNUM 2414436RES	2	2	2-18"	\$4,710	\$5,680	\$7,120
24 x 144x 36" H	U Bases	LNUT 2414436RES	2	0	4-24"	\$6,380	\$7,350	\$8,790
24 x 144x 42" H	U   Post Combo	LNUC 2414442RES	2	3	2-24"	\$5,375	\$6,345	\$7,785
24 x 144x 42" H	Inset Combo	LNUM 2414442RES	2	2	2-18"	\$4,910	\$5,880	\$7,320
24 x 144x 42" H	U Bases	LNUT 2414442RES	2	0	4-24"	\$6,740	\$7,710	\$9,150

POWER & A/V OPTIONS SEE PAGES 8-20

**TABLE OPTIONS:**

Laser cut holes in base - 1.5" x 2.5"  
 Industrial Locking Casters

WB \$100 list per table  
 CS \$70 list per caster



**FINISHES NEEDED:** <http://hi5furniture.com/finishes/>

HPL Top: Hi5 Graded-in laminates or Non-Premium Wilsonart or Formica

Edge Color: Any Hi5 standard

Base Finish: Any Hi5 standard







			
HPL Top Self edges <b>Suffix L6</b>	HPL Top Wood edges <b>Suffix L20</b>	HPL Top Plywood edges <b>Suffix L17</b>	
			
HPL Top 3mm PVC <b>Suffix L3</b>	HPL Top Knife PVC <b>Suffix L11</b>	HPL Top Knife Wood <b>Suffix L33</b>	HPL Top Knife Plywood <b>Suffix L18</b>

Table Size	Base Style	Model Code:	# Top Pieces	# of Posts	# of U Bases	List Price	List Price	List Price
30 x 42x 29" H	Inset U	LNUM 304229RES	1	0	2-18"	\$2,450	\$2,610	\$3,260
30 x 42x 29" H	U Bases	LNUT304229RES	1	0	2-30"	\$2,690	\$2,850	\$3,500
30 x 42x 36" H	Inset U	LNUM 304236RES	1	0	2-18"	\$2,630	\$2,790	\$3,440
30 x 42x 36" H	U Bases	LNUT304236RES	1	0	2-30"	\$2,870	\$3,030	\$3,680
30 x 42x 42" H	Inset U	LNUM 304242RES	1	0	2-18"	\$2,810	\$2,970	\$3,620
30 x 42x 42" H	U Bases	LNUT304242RES	1	0	2-30"	\$3,050	\$3,210	\$3,860
30 x 48x 29" H	Inset U	LNUM 304829RES	1	0	2-18"	\$2,460	\$2,625	\$3,300
30 x 48x 29" H	U Bases	LNUT304829RES	1	0	2-30"	\$2,700	\$2,865	\$3,540
30 x 48x 36" H	Inset U	LNUM 304836RES	1	0	2-18"	\$2,640	\$2,805	\$3,480
30 x 48x 36" H	U Bases	LNUT304836RES	1	0	2-30"	\$2,880	\$3,045	\$3,720
30 x 48x 42" H	Inset U	LNUM 304842RES	1	0	2-18"	\$2,820	\$2,985	\$3,660
30 x 48x 42" H	U Bases	LNUT304842RES	1	0	2-30"	\$3,060	\$3,225	\$3,900
30 x 60x 29" H	Inset U	LNUM 306029RES	1	0	2-18"	\$2,520	\$2,700	\$3,280
30 x 60x 29" H	U Bases	LNUT306029RES	1	0	2-30"	\$2,760	\$2,940	\$3,520
30 x 60x 36" H	Inset U	LNUM 306036RES	1	0	2-18"	\$2,700	\$2,880	\$3,460
30 x 60x 36" H	U Bases	LNUT306036RES	1	0	2-30"	\$2,940	\$3,120	\$3,700
30 x 60x 42" H	Inset U	LNUM 306042RES	1	0	2-18"	\$2,880	\$3,060	\$3,640
30 x 60x 42" H	U Bases	LNUT306042RES	1	0	2-30"	\$3,120	\$3,300	\$3,880
30 x 66x 29" H	Inset U	LNUM 306629RES	1	0	2-18"	\$2,590	\$2,795	\$3,550
30 x 66x 29" H	U Bases	LNUT306629RES	1	0	2-30"	\$2,950	\$3,155	\$3,910
30 x 66x 36" H	Inset U	LNUM 306636RES	1	0	2-18"	\$2,770	\$2,975	\$3,730
30 x 66x 36" H	U Bases	LNUT306636RES	1	0	2-30"	\$3,130	\$3,335	\$4,090
30 x 66x 42" H	Inset U	LNUM 306642RES	1	0	2-18"	\$2,950	\$3,155	\$3,910
30 x 66x 42" H	U Bases	LNUT306642RES	1	0	2-30"	\$3,310	\$3,515	\$4,270

POWER & A/V OPTIONS SEE PAGES 8-20

TABLE OPTIONS:

Laser cut holes in base - 1.5" x 2.5"

Industrial Locking Casters

WB

\$100 list per table

CS

\$70 list per caster



**FINISHES NEEDED:** <http://hi5furniture.com/finishes/>

HPL Top: Hi5 Graded-in laminates or Non-Premium Wilsonart or Formica

Edge Color: Any Hi5 standard

Base Finish: Any Hi5 standard

HPL Top Self edges <b>Suffix L6</b>	HPL Top Wood edges <b>Suffix L20</b>	HPL Top Plywood edges <b>Suffix L17</b>
HPL Top 3mm PVC <b>Suffix L3</b>	HPL Top Knife PVC <b>Suffix L11</b>	HPL Top Knife Wood <b>Suffix L33</b>
HPL Top Knife Plywood <b>Suffix L18</b>		

Table Size	Base Style	Model Code:	# Top Pieces	# of Posts	# of U Bases	List Price	List Price	List Price
30 x 72x 29" H	Inset U	LNUM 307229RES	1	0	2-18"	\$2,700	\$2,935	\$3,410
30 x 72x 29" H	U Bases	LNUT307229RES	1	0	2-30"	\$3,060	\$3,295	\$3,770
30 x 72x 36" H	Inset U	LNUM 307236RES	1	0	2-18"	\$2,880	\$3,115	\$3,590
30 x 72x 36" H	U Bases	LNUT307236RES	1	0	2-30"	\$3,240	\$3,475	\$3,950
30 x 72x 42" H	Inset U	LNUM 307302RES	1	0	2-18"	\$3,060	\$3,295	\$3,770
30 x 72x 42" H	U Bases	LNUT307302RES	1	0	2-30"	\$3,420	\$3,655	\$4,130
30 x 84x 29" H	U   Post Combo	LNUC 308429RES	1	1	2-30"	\$3,385	\$3,655	\$4,715
30 x 84x 29" H	Inset U	LNUM 308429RES	1	0	2-18"	\$2,820	\$3,090	\$4,150
30 x 84x 29" H	U Bases	LNUT308429RES	1	0	3-30"	\$4,140	\$4,410	\$5,470
30 x 84x 36" H	U   Post Combo	LNUC 308436RES	1	1	2-30"	\$3,575	\$3,845	\$4,905
30 x 84x 36" H	Inset U	LNUM 308436RES	1	0	2-18"	\$3,000	\$3,270	\$4,330
30 x 84x 36" H	U Bases	LNUT308436RES	1	0	3-30"	\$4,410	\$4,680	\$5,740
30 x 84x 42" H	U   Post Combo	LNUC 308442RES	1	1	2-30"	\$3,765	\$4,035	\$5,095
30 x 84x 42" H	Inset U	LNUM 308442RES	1	0	2-18"	\$3,180	\$3,450	\$4,510
30 x 84x 42" H	U Bases	LNUT308442RES	1	0	3-30"	\$4,680	\$4,950	\$6,010
30 x 96x 29" H	U   Post Combo	LNUC 309629RES	1	1	2-30"	\$3,395	\$3,670	\$4,795
30 x 96x 29" H	Inset U	LNUM 309629RES	1	0	2-18"	\$2,830	\$3,105	\$4,230
30 x 96x 29" H	U Bases	LNUT309629RES	1	0	3-30"	\$4,150	\$4,425	\$5,550
30 x 96x 36" H	U   Post Combo	LNUC 309636RES	1	1	2-30"	\$3,585	\$3,860	\$4,985
30 x 96x 36" H	Inset U	LNUM 309636RES	1	0	2-18"	\$3,010	\$3,285	\$4,410
30 x 96x 36" H	U Bases	LNUT309636RES	1	0	3-30"	\$4,420	\$4,695	\$5,820
30 x 96x 42" H	U   Post Combo	LNUC 309642RES	1	1	2-30"	\$3,775	\$4,050	\$5,175
30 x 96x 42" H	Inset U	LNUM 309642RES	1	0	2-18"	\$3,190	\$3,465	\$4,590
30 x 96x 42" H	U Bases	LNUT309642RES	1	0	3-30"	\$4,690	\$4,965	\$6,090

POWER & A/V OPTIONS SEE PAGES 8-20

TABLE OPTIONS:

Laser cut holes in base - 1.5" x 2.5"

Industrial Locking Casters

WB

\$100 list per table

CS

\$70 list per caster



**FINISHES NEEDED:** <http://hi5furniture.com/finishes/>  
HPL Top: Hi5 Graded-in laminates or Non-Premium Wilsonart or Formica  
Edge Color: Any Hi5 standard  
Base Finish: Any Hi5 standard

Table Size	Base Style	Model Code:	# Top Pieces	# of Posts	# of U Bases	List Price	List Price	List Price
30 x 108x 29" H	U   Post Combo	LNUC 3010829RES	1	1	2-30"	\$3,535	\$4,060	\$4,995
30 x 108x 29" H	Inset Combo	LNUM 3010829RES	1	1	2-18"	\$3,295	\$3,820	\$4,755
30 x 108x 29" H	U Bases	LNUT3010829RES	1	0	3-30"	\$4,290	\$4,815	\$5,750
30 x 108x 36" H	U   Post Combo	LNUC 3010836RES	1	1	2-30"	\$3,725	\$4,250	\$5,185
30 x 108x 36" H	Inset Combo	LNUM 3010836RES	1	1	2-18"	\$3,485	\$4,010	\$4,945
30 x 108x 36" H	U Bases	LNUT3010836RES	1	0	3-30"	\$4,560	\$5,085	\$6,020
30 x 108x 42" H	U   Post Combo	LNUC 3010842RES	1	1	2-30"	\$3,915	\$4,440	\$5,375
30 x 108x 42" H	Inset Combo	LNUM 3010842RES	1	1	2-18"	\$3,675	\$4,200	\$5,135
30 x 108x 42" H	U Bases	LNUT3010842RES	1	0	3-30"	\$4,830	\$5,355	\$6,290
30 x 120x 29" H	U   Post Combo	LNUC 3012029RES	1	1	2-30"	\$3,545	\$4,075	\$5,075
30 x 120x 29" H	Inset Combo	LNUM 3012029RES	1	1	2-18"	\$3,305	\$3,835	\$4,835
30 x 120x 29" H	U Bases	LNUT3012029RES	1	0	3-30"	\$4,300	\$4,830	\$5,830
30 x 120x 36" H	U   Post Combo	LNUC 3012036RES	1	1	2-30"	\$3,735	\$4,265	\$5,265
30 x 120x 36" H	Inset Combo	LNUM 3012036RES	1	1	2-18"	\$3,495	\$4,025	\$5,025
30 x 120x 36" H	U Bases	LNUT3012036RES	1	0	3-30"	\$4,570	\$5,100	\$6,100
30 x 120x 42" H	U   Post Combo	LNUC 3012042RES	1	1	2-30"	\$3,925	\$4,455	\$5,455
30 x 120x 42" H	Inset Combo	LNUM 3012042RES	1	1	2-18"	\$3,685	\$4,215	\$5,215
30 x 120x 42" H	U Bases	LNUT3012042RES	1	0	3-30"	\$4,840	\$5,370	\$6,370
30 x 132x 29" H	U   Post Combo	LNUC 3013229RES	2	3	2-30"	\$5,235	\$6,285	\$7,535
30 x 132x 29" H	Inset Combo	LNUM 3013229RES	2	2	2-18"	\$4,670	\$5,720	\$6,970
30 x 132x 29" H	U Bases	LNUT3013229RES	2	0	5-30"	\$7,500	\$8,550	\$9,800
30 x 132x 36" H	U   Post Combo	LNUC 3013236RES	2	3	2-30"	\$5,445	\$6,495	\$7,745
30 x 132x 36" H	Inset Combo	LNUM 3013236RES	2	2	2-18"	\$4,870	\$5,920	\$7,170
30 x 132x 36" H	U Bases	LNUT3013236RES	2	0	5-30"	\$7,950	\$9,000	\$10,250
30 x 132x 42" H	U   Post Combo	LNUC 3013242RES	2	3	2-30"	\$5,655	\$6,705	\$7,955
30 x 132x 42" H	Inset Combo	LNUM 3013242RES	2	2	2-18"	\$5,070	\$6,120	\$7,370
30 x 132x 42" H	U Bases	LNUT3013242RES	2	0	5-30"	\$8,400	\$9,450	\$10,700







POWER & A/V OPTIONS SEE PAGES 8-20

**TABLE OPTIONS:**

Laser cut holes in base - 1.5" x 2.5"  
Industrial Locking Casters

WB \$100 list per table  
CS \$70 list per caster



			
HPL Top Self edges <b>Suffix L6</b>	HPL Top Wood edges <b>Suffix L20</b>	HPL Top Plywood edges <b>Suffix L17</b>	
			
HPL Top 3mm PVC <b>Suffix L3</b>	HPL Top Knife PVC <b>Suffix L11</b>	HPL Top Knife Wood <b>Suffix L33</b>	HPL Top Knife Plywood <b>Suffix L18</b>

**FINISHES NEEDED:** <http://hi5furniture.com/finishes/>  
HPL Top: Hi5 Graded-in laminates or Non-Premium Wilsonart or Formica  
Edge Color: Any Hi5 standard  
Base Finish: Any Hi5 standard

Table Size	Base Style	Model Code:	# Top Pieces	# of Posts	# of U Bases	List Price	List Price	List Price
30 x 144x 29" H	U   Post Combo	LNUC 3014429RES	2	3	2-30"	\$5,285	\$6,360	\$7,805
30 x 144x 29" H	Inset Combo	LNUM 3014429RES	2	2	2-18"	\$4,720	\$5,795	\$7,240
30 x 144x 29" H	U Bases	LNUC 3014429RES	2	0	5-30"	\$7,550	\$8,625	\$10,070
30 x 144x 36" H	U   Post Combo	LNUC 3014436RES	2	3	2-30"	\$5,495	\$6,570	\$8,015
30 x 144x 36" H	Inset Combo	LNUM 3014436RES	2	2	2-18"	\$4,920	\$5,995	\$7,440
30 x 144x 36" H	U Bases	LNUC 3014436RES	2	0	5-30"	\$8,000	\$9,075	\$10,520
30 x 144x 42" H	U   Post Combo	LNUC 3014442RES	2	3	2-30"	\$5,705	\$6,780	\$8,225
30 x 144x 42" H	Inset Combo	LNUM 3014442RES	2	2	2-18"	\$5,120	\$6,195	\$7,640
30 x 144x 42" H	U Bases	LNUC 3014442RES	2	0	5-30"	\$8,450	\$9,525	\$10,970
30 x 168x 29" H	U   Post Combo	LNUC 3016829RES	2	3	2-30"	\$5,525	\$6,720	\$8,165
30 x 168x 29" H	Inset Combo	LNUM 3016829RES	2	2	2-18"	\$4,960	\$6,155	\$7,600
30 x 168x 29" H	U Bases	LNUC 3016829RES	2	0	5-30"	\$7,790	\$8,985	\$10,430
30 x 168x 36" H	U   Post Combo	LNUC 3016836RES	2	3	2-30"	\$5,735	\$6,930	\$8,375
30 x 168x 36" H	Inset Combo	LNUM 3016836RES	2	2	2-18"	\$5,160	\$6,355	\$7,800
30 x 168x 36" H	U Bases	LNUC 3016836RES	2	0	5-30"	\$8,240	\$9,435	\$10,880
30 x 168x 42" H	U   Post Combo	LNUC 3016842RES	2	3	2-30"	\$5,945	\$7,140	\$8,585
30 x 168x 42" H	Inset Combo	LNUM 3016842RES	2	2	2-18"	\$5,360	\$6,555	\$8,000
30 x 168x 42" H	U Bases	LNUC 3016842RES	2	0	5-30"	\$8,690	\$9,885	\$11,330

POWER & A/V OPTIONS SEE PAGES 8-20

**TABLE OPTIONS:**

Laser cut holes in base - 1.5" x 2.5"  
Industrial Locking Casters

WB \$100 list per table  
CS \$70 list per caster



Code: LNUC  
U / Post Combo



Code: LNUT  
U Bases



Code: LNUM  
Inset U / Post Combo

**FINISHES NEEDED:** <http://hi5furniture.com/finishes/>

HPL Top: Hi5 Graded-in laminates or Non-Premium Wilsonart or Formica

Edge Color: Any Hi5 standard

Base Finish: Any Hi5 standard

HPL Top Self edges <b>Suffix L6</b>	HPL Top Wood edges <b>Suffix L20</b>	HPL Top Plywood edges <b>Suffix L17</b>	
HPL Top 3mm PVC <b>Suffix L3</b>	HPL Top Knife PVC <b>Suffix L11</b>	HPL Top Knife Wood <b>Suffix L33</b>	HPL Top Knife Plywood <b>Suffix L18</b>

Table Size	Base Style	Model Code:	# Top Pieces	# of Posts	# of U Bases	List Price	List Price	List Price
36 x 42x 29" H	Inset U	LNUM 364229RES	1	0	2-18"	\$2,500	\$2,675	\$3,350
36 x 42x 29" H	U Bases	LNUT364229RES	1	0	2-36"	\$2,980	\$3,155	\$3,830
36 x 42x 36" H	Inset U	LNUM 364236RES	1	0	2-18"	\$2,680	\$2,855	\$3,530
36 x 42x 36" H	U Bases	LNUT364236RES	1	0	2-36"	\$3,100	\$3,275	\$3,950
36 x 42x 42" H	Inset U	LNUM 364242RES	1	0	2-18"	\$2,860	\$3,035	\$3,710
36 x 42x 42" H	U Bases	LNUT364242RES	1	0	2-36"	\$3,220	\$3,395	\$4,070
36 x 48x 29" H	Inset U	LNUM 364829RES	1	0	2-18"	\$2,510	\$2,690	\$3,400
36 x 48x 29" H	U Bases	LNUT364829RES	1	0	2-36"	\$2,990	\$3,170	\$3,880
36 x 48x 36" H	Inset U	LNUM 364836RES	1	0	2-18"	\$2,690	\$2,870	\$3,580
36 x 48x 36" H	U Bases	LNUT364836RES	1	0	2-36"	\$3,110	\$3,290	\$4,000
36 x 48x 42" H	Inset U	LNUM 364842RES	1	0	2-18"	\$2,870	\$3,050	\$3,760
36 x 48x 42" H	U Bases	LNUT364842RES	1	0	2-36"	\$3,230	\$3,410	\$4,120
36 x 60x 29" H	Inset U	LNUM 366029RES	1	0	2-18"	\$2,590	\$2,795	\$3,550
36 x 60x 29" H	U Bases	LNUT366029RES	1	0	2-36"	\$3,070	\$3,275	\$4,030
36 x 60x 36" H	Inset U	LNUM 366036RES	1	0	2-18"	\$2,770	\$2,975	\$3,730
36 x 60x 36" H	U Bases	LNUT366036RES	1	0	2-36"	\$3,190	\$3,395	\$4,150
36 x 60x 42" H	Inset U	LNUM 366042RES	1	0	2-18"	\$2,950	\$3,155	\$3,910
36 x 60x 42" H	U Bases	LNUT366042RES	1	0	2-36"	\$3,310	\$3,515	\$4,270
36 x 66x 29" H	Inset U	LNUM 366629RES	1	0	2-18"	\$2,760	\$3,015	\$4,020
36 x 66x 29" H	U Bases	LNUT366629RES	1	0	2-36"	\$3,360	\$3,615	\$4,620
36 x 66x 36" H	Inset U	LNUM 366636RES	1	0	2-18"	\$2,940	\$3,195	\$4,200
36 x 66x 36" H	U Bases	LNUT366636RES	1	0	2-36"	\$3,480	\$3,735	\$4,740
36 x 66x 42" H	Inset U	LNUM 366642RES	1	0	2-18"	\$3,120	\$3,375	\$4,380
36 x 66x 42" H	U Bases	LNUT366642RES	1	0	2-36"	\$3,600	\$3,855	\$4,860

POWER & A/V OPTIONS SEE PAGES 8-20

TABLE OPTIONS:

Laser cut holes in base - 1.5" x 2.5"

Industrial Locking Casters

WB

\$100 list per table

CS

\$70 list per caster



**FINISHES NEEDED:** <http://hi5furniture.com/finishes/>  
 HPL Top: Hi5 Graded-in laminates or Non-Premium Wilsonart or Formica  
 Edge Color: Any Hi5 standard  
 Base Finish: Any Hi5 standard

Table Size	Base Style	Model Code:	# Top Pieces	# of Posts	# of U Bases	List Price	List Price	List Price
36 x 72x 29" H	Inset U	LNUM 367229RES	1	0	2-18"	\$2,770	\$3,025	\$4,060
36 x 72x 29" H	U Bases	LNUT367229RES	1	0	2-36"	\$3,370	\$3,625	\$4,660
36 x 72x 36" H	Inset U	LNUM 367236RES	1	0	2-18"	\$2,950	\$3,205	\$4,240
36 x 72x 36" H	U Bases	LNUT367236RES	1	0	2-36"	\$3,490	\$3,745	\$4,780
36 x 72x 42" H	Inset U	LNUM 367242RES	1	0	2-18"	\$3,130	\$3,385	\$4,420
36 x 72x 42" H	U Bases	LNUT367242RES	1	0	2-36"	\$3,610	\$3,865	\$4,900
36 x 84x 29" H	U   Post Combo	LNUC 368429RES	1	2	2-36"	\$4,050	\$4,350	\$5,410
36 x 84x 29" H	Inset U	LNUM 368429RES	1	0	2-18"	\$2,920	\$3,220	\$4,280
36 x 84x 29" H	U Bases	LNUT368429RES	1	0	3-36"	\$4,600	\$4,900	\$5,960
36 x 84x 36" H	U   Post Combo	LNUC 368436RES	1	2	2-36"	\$4,190	\$4,490	\$5,550
36 x 84x 36" H	Inset U	LNUM 368436RES	1	0	2-18"	\$3,100	\$3,400	\$4,460
36 x 84x 36" H	U Bases	LNUT368436RES	1	0	3-36"	\$4,780	\$5,080	\$6,140
36 x 84x 42" H	U   Post Combo	LNUC 368442RES	1	2	2-36"	\$4,330	\$4,630	\$5,690
36 x 84x 42" H	Inset U	LNUM 368442RES	1	0	2-18"	\$3,280	\$3,580	\$4,640
36 x 84x 42" H	U Bases	LNUT368442RES	1	0	3-36"	\$4,960	\$5,260	\$6,320
36 x 96x 29" H	U   Post Combo	LNUC 369629RES	1	2	2-36"	\$4,060	\$4,365	\$5,500
36 x 96x 29" H	Inset U	LNUM 369629RES	1	0	2-18"	\$2,930	\$3,235	\$4,370
36 x 96x 29" H	U Bases	LNUT369629RES	1	0	3-36"	\$4,610	\$4,915	\$6,050
36 x 96x 36" H	U   Post Combo	LNUC 369636RES	1	2	2-36"	\$4,200	\$4,505	\$5,640
36 x 96x 36" H	Inset U	LNUM 369636RES	1	0	2-18"	\$3,110	\$3,415	\$4,550
36 x 96x 36" H	U Bases	LNUT369636RES	1	0	3-36"	\$4,790	\$5,095	\$6,230
36 x 96x 42" H	U   Post Combo	LNUC 369642RES	1	2	2-36"	\$4,340	\$4,645	\$5,780
36 x 96x 42" H	Inset U	LNUM 369642RES	1	0	2-18"	\$3,290	\$3,595	\$4,730
36 x 96x 42" H	U Bases	LNUT369642RES	1	0	3-36"	\$4,970	\$5,275	\$6,410

POWER & A/V OPTIONS SEE PAGES 8-20

TABLE OPTIONS:

Laser cut holes in base - 1.5" x 2.5"  
 Industrial Locking Casters

WB \$100 list per table  
 CS \$70 list per caster





**FINISHES NEEDED:** <http://hi5furniture.com/finishes/>  
HPL Top: Hi5 Graded-in laminates or Non-Premium Wilsonart or Formica  
Edge Color: Any Hi5 standard  
Base Finish: Any Hi5 standard

Table Size	Base Style	Model Code:	# Top Pieces	# of Posts	# of U Bases	List Price	List Price	List Price
36 x 108x 29" H	U   Post Combo	LNUC 3610829RES	1	2	2-36"	\$4,220	\$4,805	\$5,720
36 x 108x 29" H	Inset Combo	LNUM 3610829RES	1	2	2-18"	\$3,740	\$4,325	\$5,240
36 x 108x 29" H	U Bases	LNUT3610829RES	1	0	3-36"	\$4,770	\$5,355	\$6,270
36 x 108x 36" H	U   Post Combo	LNUC 3610836RES	1	2	2-36"	\$4,360	\$4,945	\$5,860
36 x 108x 36" H	Inset Combo	LNUM 3610836RES	1	2	2-18"	\$3,940	\$4,525	\$5,440
36 x 108x 36" H	U Bases	LNUT3610836RES	1	0	3-36"	\$4,950	\$5,535	\$6,450
36 x 108x 42" H	U   Post Combo	LNUC 3610842RES	1	2	2-36"	\$4,500	\$5,085	\$6,000
36 x 108x 42" H	Inset Combo	LNUM 3610842RES	1	2	2-18"	\$4,140	\$4,725	\$5,640
36 x 108x 42" H	U Bases	LNUT3610842RES	1	0	3-36"	\$5,130	\$5,715	\$6,630
36 x 120x 29" H	U   Post Combo	LNUC 3612029RES	1	2	2-36"	\$4,240	\$4,835	\$5,800
36 x 120x 29" H	Inset Combo	LNUM 3612029RES	1	2	2-18"	\$3,760	\$4,355	\$5,320
36 x 120x 29" H	U Bases	LNUT3612029RES	1	0	3-36"	\$4,790	\$5,385	\$6,350
36 x 120x 36" H	U   Post Combo	LNUC 3612036RES	1	2	2-36"	\$4,380	\$4,975	\$5,940
36 x 120x 36" H	Inset Combo	LNUM 3612036RES	1	2	2-18"	\$3,960	\$4,555	\$5,520
36 x 120x 36" H	U Bases	LNUT3612036RES	1	0	3-36"	\$4,970	\$5,565	\$6,530
36 x 120x 42" H	U   Post Combo	LNUC 3612042RES	1	2	2-36"	\$4,520	\$5,115	\$6,080
36 x 120x 42" H	Inset Combo	LNUM 3612042RES	1	2	2-18"	\$4,160	\$4,755	\$5,720
36 x 120x 42" H	U Bases	LNUT3612042RES	1	0	3-36"	\$5,150	\$5,745	\$6,710
36 x 132x 29" H	U   Post Combo	LNUC 3613229RES	2	6	2-36"	\$6,660	\$7,815	\$8,940
36 x 132x 29" H	Inset Combo	LNUM 3613229RES	2	4	2-18"	\$5,530	\$6,685	\$7,810
36 x 132x 29" H	U Bases	LNUT3613229RES	2	0	5-36"	\$8,310	\$9,465	\$10,590
36 x 132x 36" H	U   Post Combo	LNUC 3613236RES	2	6	2-36"	\$6,840	\$7,995	\$9,120
36 x 132x 36" H	Inset Combo	LNUM 3613236RES	2	4	2-18"	\$5,750	\$6,905	\$8,030
36 x 132x 36" H	U Bases	LNUT3613236RES	2	0	5-36"	\$8,610	\$9,765	\$10,890
36 x 132x 42" H	U   Post Combo	LNUC 3613242RES	2	6	2-36"	\$7,020	\$8,175	\$9,300
36 x 132x 42" H	Inset Combo	LNUM 3613242RES	2	4	2-18"	\$5,970	\$7,125	\$8,250
36 x 132x 42" H	U Bases	LNUT3613242RES	2	0	5-36"	\$8,910	\$10,065	\$11,190

POWER & A/V OPTIONS SEE PAGES 8-20

**TABLE OPTIONS:**

Laser cut holes in base - 1.5" x 2.5"  
Industrial Locking Casters

WB \$100 list per table  
CS \$70 list per caster



**FINISHES NEEDED:** <http://hi5furniture.com/finishes/>  
 HPL Top: Hi5 Graded-in laminates or Non-Premium Wilsonart or Formica  
 Edge Color: Any Hi5 standard  
 Base Finish: Any Hi5 standard

Table Size	Base Style	Model Code:	# Top Pieces	# of Posts	# of U Bases	List Price	List Price	List Price
36 x 144x 29" H	U   Post Combo	LNUC 3614429RES	2	6	2-36"	\$6,720	\$7,905	\$9,240
36 x 144x 29" H	Inset Combo	LNUM 3614429RES	2	4	2-18"	\$5,590	\$6,775	\$8,110
36 x 144x 29" H	U Bases	LNUT3614429RES	2	0	5-36"	\$8,370	\$9,555	\$10,890
36 x 144x 36" H	U   Post Combo	LNUC 3614436RES	2	6	2-36"	\$6,900	\$8,085	\$9,420
36 x 144x 36" H	Inset Combo	LNUM 3614436RES	2	4	2-18"	\$5,810	\$6,995	\$8,330
36 x 144x 36" H	U Bases	LNUT3614436RES	2	0	5-36"	\$8,670	\$9,855	\$11,190
36 x 144x 42" H	U   Post Combo	LNUC 3614442RES	2	6	2-36"	\$7,080	\$8,265	\$9,600
36 x 144x 42" H	Inset Combo	LNUM 3614442RES	2	4	2-18"	\$6,030	\$7,215	\$8,550
36 x 144x 42" H	U Bases	LNUT3614442RES	2	0	5-36"	\$8,970	\$10,155	\$11,490
36 x 168x 29" H	U   Post Combo	LNUC 3616829RES	2	6	2-36"	\$7,000	\$8,325	\$9,640
36 x 168x 29" H	Inset Combo	LNUM 3616829RES	2	6	2-18"	\$6,520	\$7,845	\$9,160
36 x 168x 29" H	U Bases	LNUT3616829RES	2	0	5-36"	\$8,650	\$9,975	\$11,290
36 x 168x 36" H	U   Post Combo	LNUC 3616836RES	2	6	2-36"	\$7,180	\$8,505	\$9,820
36 x 168x 36" H	Inset Combo	LNUM 3616836RES	2	6	2-18"	\$6,760	\$8,085	\$9,400
36 x 168x 36" H	U Bases	LNUT3616836RES	2	0	5-36"	\$8,950	\$10,275	\$11,590
36 x 168x 42" H	U   Post Combo	LNUC 3616842RES	2	6	2-36"	\$7,360	\$8,685	\$10,000
36 x 168x 42" H	Inset Combo	LNUM 3616842RES	2	6	2-18"	\$7,000	\$8,325	\$9,640
36 x 168x 42" H	U Bases	LNUT3616842RES	2	0	5-36"	\$9,250	\$10,575	\$11,890
36 x 192x 29" H	U   Post Combo	LNUC 3619229RES	2	6	2-36"	\$7,030	\$8,370	\$9,790
36 x 192x 29" H	Inset Combo	LNUM 3619229RES	2	6	2-18"	\$6,550	\$7,890	\$9,310
36 x 192x 29" H	U Bases	LNUT3619229RES	2	0	5-36"	\$8,680	\$10,020	\$11,440
36 x 192x 36" H	U   Post Combo	LNUC 3619236RES	2	6	2-36"	\$7,210	\$8,550	\$9,970
36 x 192x 36" H	Inset Combo	LNUM 3619236RES	2	6	2-18"	\$6,790	\$8,130	\$9,550
36 x 192x 36" H	U Bases	LNUT3619236RES	2	0	5-36"	\$8,980	\$10,320	\$11,740
36 x 192x 42" H	U   Post Combo	LNUC 3619242RES	2	6	2-36"	\$7,390	\$8,730	\$10,150
36 x 192x 42" H	Inset Combo	LNUM 3619242RES	2	6	2-18"	\$7,030	\$8,370	\$9,790
36 x 192x 42" H	U Bases	LNUT3619242RES	2	0	5-36"	\$9,280	\$10,620	\$12,040

POWER & A/V OPTIONS SEE PAGES 8-20

**TABLE OPTIONS:**

Laser cut holes in base - 1.5" x 2.5"  
 Industrial Locking Casters

WB \$100 list per table  
 CS \$70 list per caster



**FINISHES NEEDED:** <http://hi5furniture.com/finishes/>  
 HPL Top: Hi5 Graded-in laminates or Non-Premium Wilsonart or Formica  
 Edge Color: Any Hi5 standard  
 Base Finish: Any Hi5 standard

Table Size	Base Style	Model Code:	# Top Pieces	# of Posts	# of U Bases	List Price	List Price	List Price
36 x 216x 29" H	U   Post Combo	LNUC 3621629RES	2	6	2-36"	\$7,310	\$8,790	\$10,180
36 x 216x 29" H	Inset Combo	LNUM 3621629RES	2	6	2-18"	\$6,830	\$8,310	\$9,700
36 x 216x 29" H	U Bases	LNUT3621629RES	2	0	5-36"	\$8,960	\$10,440	\$11,830
36 x 216x 36" H	U   Post Combo	LNUC 3621636RES	2	6	2-36"	\$7,490	\$8,970	\$10,360
36 x 216x 36" H	Inset Combo	LNUM 3621636RES	2	6	2-18"	\$7,070	\$8,550	\$9,940
36 x 216x 36" H	U Bases	LNUT3621636RES	2	0	5-36"	\$9,260	\$10,740	\$12,130
36 x 216x 42" H	U   Post Combo	LNUC 3621642RES	2	6	2-36"	\$7,670	\$9,150	\$10,540
36 x 216x 42" H	Inset Combo	LNUM 3621642RES	2	6	2-18"	\$7,310	\$8,790	\$10,180
36 x 216x 42" H	U Bases	LNUT3621642RES	2	0	5-36"	\$9,560	\$11,040	\$12,430
36 x 240x 29" H	U   Post Combo	LNUC 3624029RES	2	6	2-36"	\$7,340	\$8,835	\$10,330
36 x 240x 29" H	Inset Combo	LNUM 3624029RES	2	6	2-18"	\$6,860	\$8,355	\$9,850
36 x 240x 29" H	U Bases	LNUT3624029RES	2	0	5-36"	\$8,990	\$10,485	\$11,980
36 x 240x 36" H	U   Post Combo	LNUC 3624036RES	2	6	2-36"	\$7,520	\$9,015	\$10,510
36 x 240x 36" H	Inset Combo	LNUM 3624036RES	2	6	2-18"	\$7,100	\$8,595	\$10,090
36 x 240x 36" H	U Bases	LNUT3624036RES	2	0	5-36"	\$9,290	\$10,785	\$12,280
36 x 240x 42" H	U   Post Combo	LNUC 3624042RES	2	6	2-36"	\$7,700	\$9,195	\$10,690
36 x 240x 42" H	Inset Combo	LNUM 3624042RES	2	6	2-18"	\$7,340	\$8,835	\$10,330
36 x 240x 42" H	U Bases	LNUT3624042RES	2	0	5-36"	\$9,590	\$11,085	\$12,580

POWER & A/V OPTIONS SEE PAGES 8-20

TABLE OPTIONS:

Laser cut holes in base - 1.5" x 2.5"  
 Industrial Locking Casters

WB \$100 list per table  
 CS \$70 list per caster



**FINISHES NEEDED:** <http://hi5furniture.com/finishes/>  
HPL Top: Hi5 Graded-in laminates or Non-Premium Wilsonart or Formica  
Edge Color: Any Hi5 standard  
Base Finish: Any Hi5 standard

Table Size	Base Style	Model Code:	# Top Pieces	# of Posts	# of U Bases	List Price	List Price	List Price
42 x 60x 29" H	U   Post Combo	LNUC 426029RES	1	2	2-42"	\$4,060	\$4,330	\$5,320
42 x 60x 29" H	Inset U	LNUM 426029RES	1	0	2-24"	\$2,930	\$3,200	\$4,190
42 x 60x 29" H	U Bases	LNUT 426029RES	1	0	3-42"	\$4,670	\$4,940	\$5,930
42 x 60x 36" H	U   Post Combo	LNUC 426036RES	1	2	2-42"	\$4,200	\$4,470	\$5,460
42 x 60x 36" H	Inset U	LNUM 426036RES	1	0	2-24"	\$3,110	\$3,380	\$4,370
42 x 60x 36" H	U Bases	LNUT 426036RES	1	0	3-42"	\$4,850	\$5,120	\$6,110
42 x 60x 42" H	U   Post Combo	LNUC 426042RES	1	2	2-42"	\$4,340	\$4,610	\$5,600
42 x 60x 42" H	Inset U	LNUM 426042RES	1	0	2-24"	\$3,290	\$3,560	\$4,550
42 x 60x 42" H	U Bases	LNUT 426042RES	1	0	3-42"	\$5,030	\$5,300	\$6,290
42 x 66x 29" H	U   Post Combo	LNUC 426629RES	1	2	2-42"	\$4,160	\$4,460	\$5,450
42 x 66x 29" H	Inset U	LNUM 426629RES	1	0	2-24"	\$3,030	\$3,330	\$4,320
42 x 66x 29" H	U Bases	LNUT 426629RES	1	0	3-42"	\$4,770	\$5,070	\$6,060
42 x 66x 36" H	U   Post Combo	LNUC 426636RES	1	2	2-42"	\$4,300	\$4,600	\$5,590
42 x 66x 36" H	Inset U	LNUM 426636RES	1	0	2-24"	\$3,210	\$3,510	\$4,500
42 x 66x 36" H	U Bases	LNUT 426636RES	1	0	3-42"	\$4,950	\$5,250	\$6,240
42 x 66x 42" H	U   Post Combo	LNUC 426642RES	1	2	2-42"	\$4,440	\$4,740	\$5,730
42 x 66x 42" H	Inset U	LNUM 426642RES	1	0	2-24"	\$3,390	\$3,690	\$4,680
42 x 66x 42" H	U Bases	LNUT 426642RES	1	0	3-42"	\$5,130	\$5,430	\$6,420
42 x 72x 29" H	U   Post Combo	LNUC 427229RES	1	2	2-42"	\$4,160	\$4,460	\$5,490
42 x 72x 29" H	Inset U	LNUM 427229RES	1	0	2-24"	\$3,030	\$3,330	\$4,360
42 x 72x 29" H	U Bases	LNUT 427229RES	1	0	3-42"	\$4,770	\$5,070	\$6,100
42 x 72x 36" H	U   Post Combo	LNUC 427236RES	1	2	2-42"	\$4,300	\$4,600	\$5,630
42 x 72x 36" H	Inset U	LNUM 427236RES	1	0	2-24"	\$3,210	\$3,510	\$4,540
42 x 72x 36" H	U Bases	LNUT 427236RES	1	0	3-42"	\$4,950	\$5,250	\$6,280
42 x 72x 42" H	U   Post Combo	LNUC 427242RES	1	2	2-42"	\$4,440	\$4,740	\$5,770
42 x 72x 42" H	Inset U	LNUM 427242RES	1	0	2-24"	\$3,390	\$3,690	\$4,720
42 x 72x 42" H	U Bases	LNUT 427242RES	1	0	3-42"	\$5,130	\$5,430	\$6,460

POWER & A/V OPTIONS SEE PAGES 8-20

**TABLE OPTIONS:**

Laser cut holes in base - 1.5" x 2.5"  
Industrial Locking Casters

WB \$100 list per table  
CS \$70 list per caster



**FINISHES NEEDED:** <http://hi5furniture.com/finishes/>  
HPL Top: Hi5 Graded-in laminates or Non-Premium Wilsonart or Formica  
Edge Color: Any Hi5 standard  
Base Finish: Any Hi5 standard

Table Size	Base Style	Model Code:	# Top Pieces	# of Posts	# of U Bases	List Price	List Price	List Price
42 x 84x 29" H	U   Post Combo	LNUC 428429RES	1	2	2-42"	\$4,360	\$4,720	\$5,760
42 x 84x 29" H	Inset U	LNUM 428429RES	1	0	2-24"	\$3,230	\$3,590	\$4,630
42 x 84x 29" H	U Bases	LNUT 428429RES	1	0	3-42"	\$4,970	\$5,330	\$6,370
42 x 84x 36" H	U   Post Combo	LNUC 428436RES	1	2	2-42"	\$4,500	\$4,860	\$5,900
42 x 84x 36" H	Inset U	LNUM 428436RES	1	0	2-24"	\$3,410	\$3,770	\$4,810
42 x 84x 36" H	U Bases	LNUT 428436RES	1	0	3-42"	\$5,150	\$5,510	\$6,550
42 x 84x 42" H	U   Post Combo	LNUC 428442RES	1	2	2-42"	\$4,640	\$5,000	\$6,040
42 x 84x 42" H	Inset U	LNUM 428442RES	1	0	2-24"	\$3,590	\$3,950	\$4,990
42 x 84x 42" H	U Bases	LNUT 428442RES	1	0	3-42"	\$5,330	\$5,690	\$6,730
42 x 96x 29" H	U   Post Combo	LNUC 429629RES	1	2	2-42"	\$4,380	\$4,745	\$5,840
42 x 96x 29" H	Inset U	LNUM 429629RES	1	0	2-24"	\$3,250	\$3,615	\$4,710
42 x 96x 29" H	U Bases	LNUT 429629RES	1	0	3-42"	\$4,990	\$5,355	\$6,450
42 x 96x 36" H	U   Post Combo	LNUC 429636RES	1	2	2-42"	\$4,520	\$4,885	\$5,980
42 x 96x 36" H	Inset U	LNUM 429636RES	1	0	2-24"	\$3,430	\$3,795	\$4,890
42 x 96x 36" H	U Bases	LNUT 429636RES	1	0	3-42"	\$5,170	\$5,535	\$6,630
42 x 96x 42" H	U   Post Combo	LNUC 429642RES	1	2	2-42"	\$4,660	\$5,025	\$6,120
42 x 96x 42" H	Inset U	LNUM 429642RES	1	0	2-24"	\$3,610	\$3,975	\$5,070
42 x 96x 42" H	U Bases	LNUT 429642RES	1	0	3-42"	\$5,350	\$5,715	\$6,810
42 x 108x 29" H	U   Post Combo	LNUC 4210829RES	1	2	2-42"	\$4,580	\$5,285	\$6,110
42 x 108x 29" H	Inset Combo	LNUM 4210829RES	1	2	2-24"	\$4,100	\$4,805	\$5,630
42 x 108x 29" H	U Bases	LNUT 4210829RES	1	0	3-42"	\$5,190	\$5,895	\$6,720
42 x 108x 36" H	U   Post Combo	LNUC 4210836RES	1	2	2-42"	\$4,720	\$5,425	\$6,250
42 x 108x 36" H	Inset Combo	LNUM 4210836RES	1	2	2-24"	\$4,300	\$5,005	\$5,830
42 x 108x 36" H	U Bases	LNUT 4210836RES	1	0	3-42"	\$5,370	\$6,075	\$6,900
42 x 108x 42" H	U   Post Combo	LNUC 4210842RES	1	2	2-42"	\$4,860	\$5,565	\$6,390
42 x 108x 42" H	Inset Combo	LNUM 4210842RES	1	2	2-24"	\$4,500	\$5,205	\$6,030
42 x 108x 42" H	U Bases	LNUT 4210842RES	1	0	3-42"	\$5,550	\$6,255	\$7,080

POWER & A/V OPTIONS SEE PAGES 8-20

**TABLE OPTIONS:**

Laser cut holes in base - 1.5" x 2.5"  
Industrial Locking Casters

WB \$100 list per table  
CS \$70 list per caster



**FINISHES NEEDED:** <http://hi5furniture.com/finishes/>  
 HPL Top: Hi5 Graded-in laminates or Non-Premium Wilsonart or Formica  
 Edge Color: Any Hi5 standard  
 Base Finish: Any Hi5 standard

Table Size	Base Style	Model Code:	# Top Pieces	# of Posts	# of U Bases	List Price	List Price	List Price
42 x 120x 29" H	U   Post Combo	LNU C 4212029RES	1	2	2-42"	\$4,600	\$5,315	\$6,200
42 x 120x 29" H	Inset Combo	LNUM 4212029RES	1	2	2-24"	\$4,120	\$4,835	\$5,720
42 x 120x 29" H	U Bases	LNU T 4212029RES	1	0	3-42"	\$5,210	\$5,925	\$6,810
42 x 120x 36" H	U   Post Combo	LNU C 4212036RES	1	2	2-42"	\$4,740	\$5,455	\$6,340
42 x 120x 36" H	Inset Combo	LNUM 4212036RES	1	2	2-24"	\$4,320	\$5,035	\$5,920
42 x 120x 36" H	U Bases	LNU T 4212036RES	1	0	3-42"	\$5,390	\$6,105	\$6,990
42 x 120x 42" H	U   Post Combo	LNU C 4212042RES	1	2	2-42"	\$4,880	\$5,595	\$6,480
42 x 120x 42" H	Inset Combo	LNUM 4212042RES	1	2	2-24"	\$4,520	\$5,235	\$6,120
42 x 120x 42" H	U Bases	LNU T 4212042RES	1	0	3-42"	\$5,570	\$6,285	\$7,170
42 x 132x 29" H	U   Post Combo	LNU C 4213229RES	2	6	2-42"	\$7,040	\$8,325	\$9,340
42 x 132x 29" H	Inset Combo	LNUM 4213229RES	2	4	2-24"	\$5,910	\$7,195	\$8,210
42 x 132x 29" H	U Bases	LNU T 4213229RES	2	0	5-42"	\$8,870	\$10,155	\$11,170
42 x 132x 36" H	U   Post Combo	LNU C 4213236RES	2	6	2-42"	\$7,220	\$8,505	\$9,520
42 x 132x 36" H	Inset Combo	LNUM 4213236RES	2	4	2-24"	\$6,130	\$7,415	\$8,430
42 x 132x 36" H	U Bases	LNU T 4213236RES	2	0	5-42"	\$9,170	\$10,455	\$11,470
42 x 132x 42" H	U   Post Combo	LNU C 4213242RES	2	6	2-42"	\$7,400	\$8,685	\$9,700
42 x 132x 42" H	Inset Combo	LNUM 4213242RES	2	4	2-24"	\$6,350	\$7,635	\$8,650
42 x 132x 42" H	U Bases	LNU T 4213242RES	2	0	5-42"	\$9,470	\$10,755	\$11,770
42 x 144x 29" H	U   Post Combo	LNU C 4214429RES	2	6	2-42"	\$7,110	\$8,430	\$9,680
42 x 144x 29" H	Inset Combo	LNUM 4214429RES	2	4	2-24"	\$5,980	\$7,300	\$8,550
42 x 144x 29" H	U Bases	LNU T 4214429RES	2	0	5-42"	\$8,940	\$10,260	\$11,510
42 x 144x 36" H	U   Post Combo	LNU C 4214436RES	2	6	2-42"	\$7,290	\$8,610	\$9,860
42 x 144x 36" H	Inset Combo	LNUM 4214436RES	2	4	2-24"	\$6,200	\$7,520	\$8,770
42 x 144x 36" H	U Bases	LNU T 4214436RES	2	0	5-42"	\$9,240	\$10,560	\$11,810
42 x 144x 42" H	U   Post Combo	LNU C 4214442RES	2	6	2-42"	\$7,470	\$8,790	\$10,040
42 x 144x 42" H	Inset Combo	LNUM 4214442RES	2	4	2-24"	\$6,420	\$7,740	\$8,990
42 x 144x 42" H	U Bases	LNU T 4214442RES	2	0	5-42"	\$9,540	\$10,860	\$12,110

POWER & A/V OPTIONS SEE PAGES 8-20

**TABLE OPTIONS:**

Laser cut holes in base - 1.5" x 2.5"  
 Industrial Locking Casters

WB \$100 list per table  
 CS \$70 list per caster



**FINISHES NEEDED:** <http://hi5furniture.com/finishes/>  
 HPL Top: Hi5 Graded-in laminates or Non-Premium Wilsonart or Formica  
 Edge Color: Any Hi5 standard  
 Base Finish: Any Hi5 standard

Table Size	Base Style	Model Code:	# Top Pieces	# of Posts	# of U Bases	List Price	List Price	List Price
42 x 168x 29" H	U   Post Combo	LNUC 4216829RES	2	6	2-42"	\$7,470	\$8,970	\$10,160
42 x 168x 29" H	Inset Combo	LNUM 4216829RES	2	6	2-24"	\$6,990	\$8,490	\$9,680
42 x 168x 29" H	U Bases	LNUT 4216829RES	2	0	5-42"	\$9,300	\$10,800	\$11,990
42 x 168x 36" H	U   Post Combo	LNUC 4216836RES	2	6	2-42"	\$7,650	\$9,150	\$10,340
42 x 168x 36" H	Inset Combo	LNUM 4216836RES	2	6	2-24"	\$7,230	\$8,730	\$9,920
42 x 168x 36" H	U Bases	LNUT 4216836RES	2	0	5-42"	\$9,600	\$11,100	\$12,290
42 x 168x 42" H	U   Post Combo	LNUC 4216842RES	2	6	2-42"	\$7,830	\$9,330	\$10,520
42 x 168x 42" H	Inset Combo	LNUM 4216842RES	2	6	2-24"	\$7,470	\$8,970	\$10,160
42 x 168x 42" H	U Bases	LNUT 4216842RES	2	0	5-42"	\$9,900	\$11,400	\$12,590
42 x 192x 29" H	U   Post Combo	LNUC 4219229RES	2	6	2-42"	\$7,500	\$9,015	\$10,310
42 x 192x 29" H	Inset Combo	LNUM 4219229RES	2	6	2-24"	\$7,020	\$8,535	\$9,830
42 x 192x 29" H	U Bases	LNUT 4219229RES	2	0	5-42"	\$9,330	\$10,845	\$12,140
42 x 192x 36" H	U   Post Combo	LNUC 4219236RES	2	6	2-42"	\$7,680	\$9,195	\$10,490
42 x 192x 36" H	Inset Combo	LNUM 4219236RES	2	6	2-24"	\$7,260	\$8,775	\$10,070
42 x 192x 36" H	U Bases	LNUT 4219236RES	2	0	5-42"	\$9,630	\$11,145	\$12,440
42 x 192x 42" H	U   Post Combo	LNUC 4219242RES	2	6	2-42"	\$7,860	\$9,375	\$10,670
42 x 192x 42" H	Inset Combo	LNUM 4219242RES	2	6	2-24"	\$7,500	\$9,015	\$10,310
42 x 192x 42" H	U Bases	LNUT 4219242RES	2	0	5-42"	\$9,930	\$11,445	\$12,740
42 x 216x 29" H	U   Post Combo	LNUC 4221629RES	2	6	2-42"	\$7,860	\$9,555	\$10,780
42 x 216x 29" H	Inset Combo	LNUM 4221629RES	2	6	2-24"	\$7,380	\$9,075	\$10,300
42 x 216x 29" H	U Bases	LNUT 4221629RES	2	0	5-42"	\$9,690	\$11,385	\$12,610
42 x 216x 36" H	U   Post Combo	LNUC 4221636RES	2	6	2-42"	\$8,040	\$9,735	\$10,960
42 x 216x 36" H	Inset Combo	LNUM 4221636RES	2	6	2-24"	\$7,620	\$9,315	\$10,540
42 x 216x 36" H	U Bases	LNUT 4221636RES	2	0	5-42"	\$9,990	\$11,685	\$12,910
42 x 216x 42" H	U   Post Combo	LNUC 4221642RES	2	6	2-42"	\$8,220	\$9,915	\$11,140
42 x 216x 42" H	Inset Combo	LNUM 4221642RES	2	6	2-24"	\$7,860	\$9,555	\$10,780
42 x 216x 42" H	U Bases	LNUT 4221642RES	2	0	5-42"	\$10,290	\$11,985	\$13,210

POWER & A/V OPTIONS SEE PAGES 8-20

**TABLE OPTIONS:**

Laser cut holes in base - 1.5" x 2.5"  
 Industrial Locking Casters

WB \$100 list per table  
 CS \$70 list per caster



**FINISHES NEEDED:** <http://hi5furniture.com/finishes/>

HPL Top: Hi5 Graded-in laminates or Non-Premium Wilsonart or Formica

Edge Color: Any Hi5 standard

Base Finish: Any Hi5 standard

HPL Top Self edges <b>Suffix L6</b>	HPL Top Wood edges <b>Suffix L20</b>	HPL Top Plywood edges <b>Suffix L17</b>	
HPL Top 3mm PVC <b>Suffix L3</b>	HPL Top Knife PVC <b>Suffix L11</b>	HPL Top Knife Wood <b>Suffix L33</b>	HPL Top Knife Plywood <b>Suffix L18</b>

Table Size	Base Style	Model Code:	# Top Pieces	# of Posts	# of U Bases	List Price	List Price	List Price
42 x 240x 29" H	U   Post Combo	LNUC 4224029RES	2	6	2-42"	\$7,890	\$9,600	\$10,930
42 x 240x 29" H	Inset Combo	LNUM 4224029RES	2	6	2-24"	\$7,410	\$9,120	\$10,450
42 x 240x 29" H	U Bases	LNUT 4224029RES	2	0	5-42"	\$9,720	\$11,430	\$12,760
42 x 240x 36" H	U   Post Combo	LNUC 4224036RES	2	6	2-42"	\$8,070	\$9,780	\$11,110
42 x 240x 36" H	Inset Combo	LNUM 4224036RES	2	6	2-24"	\$7,650	\$9,360	\$10,690
42 x 240x 36" H	U Bases	LNUT 4224036RES	2	0	5-42"	\$10,020	\$11,730	\$13,060
42 x 240x 42" H	U   Post Combo	LNUC 4224042RES	2	6	2-42"	\$8,250	\$9,960	\$11,290
42 x 240x 42" H	Inset Combo	LNUM 4224042RES	2	6	2-24"	\$7,890	\$9,600	\$10,930
42 x 240x 42" H	U Bases	LNUT 4224042RES	2	0	5-42"	\$10,320	\$12,030	\$13,360

POWER & A/V OPTIONS SEE PAGES 8-20

TABLE OPTIONS:

Laser cut holes in base - 1.5" x 2.5"

Industrial Locking Casters

WB

\$100 list per table

CS

\$70 list per caster



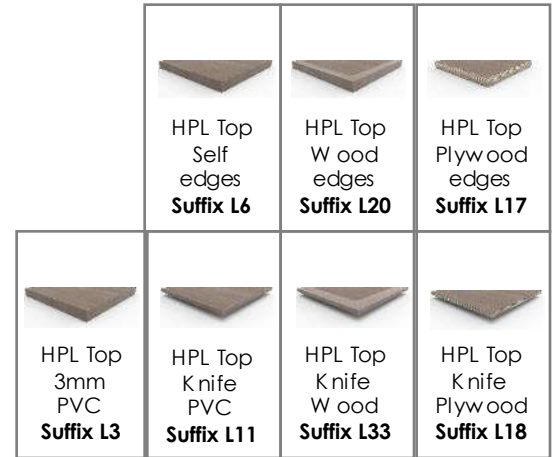

**FINISHES NEEDED:** <http://hi5furniture.com/finishes/>  
 HPL Top: Hi5 Graded-in laminates or Non-Premium Wilsonart or Formica  
 Edge Color: Any Hi5 standard  
 Base Finish: Any Hi5 standard

Table Size	Base Style	Model Code:	# Top Pieces	# of Posts	# of U Bases	List Price	List Price	List Price
48 x 60x 29" H	U   Post Combo	LNUC 486029RES	1	2	2-48"	\$4,180	\$4,450	\$5,480
48 x 60x 29" H	Inset U	LNUM 486029RES	1	0	2-24"	\$2,930	\$3,200	\$4,230
48 x 60x 29" H	U Bases	LNUT 486029RES	1	0	3-48"	\$4,850	\$5,120	\$6,150
48 x 60x 36" H	U   Post Combo	LNUC 486036RES	1	2	2-48"	\$4,320	\$4,590	\$5,620
48 x 60x 36" H	Inset U	LNUM 486036RES	1	0	2-24"	\$3,110	\$3,380	\$4,410
48 x 60x 36" H	U Bases	LNUT 486036RES	1	0	3-48"	\$5,030	\$5,300	\$6,330
48 x 60x 42" H	U   Post Combo	LNUC 486042RES	1	2	2-48"	\$4,460	\$4,730	\$5,760
48 x 60x 42" H	Inset U	LNUM 486042RES	1	0	2-24"	\$3,290	\$3,560	\$4,590
48 x 60x 42" H	U Bases	LNUT 486042RES	1	0	3-48"	\$5,210	\$5,480	\$6,510
48 x 66x 29" H	U   Post Combo	LNUC 486629RES	1	2	2-48"	\$4,280	\$4,580	\$5,610
48 x 66x 29" H	Inset U	LNUM 486629RES	1	0	2-24"	\$3,030	\$3,330	\$4,360
48 x 66x 29" H	U Bases	LNUT 486629RES	1	0	3-48"	\$4,950	\$5,250	\$6,280
48 x 66x 36" H	U   Post Combo	LNUC 486636RES	1	2	2-48"	\$4,420	\$4,720	\$5,750
48 x 66x 36" H	Inset U	LNUM 486636RES	1	0	2-24"	\$3,210	\$3,510	\$4,540
48 x 66x 36" H	U Bases	LNUT 486636RES	1	0	3-48"	\$5,130	\$5,430	\$6,460
48 x 66x 42" H	U   Post Combo	LNUC 486642RES	1	2	2-48"	\$4,560	\$4,860	\$5,890
48 x 66x 42" H	Inset U	LNUM 486642RES	1	0	2-24"	\$3,390	\$3,690	\$4,720
48 x 66x 42" H	U Bases	LNUT 486642RES	1	0	3-48"	\$5,310	\$5,610	\$6,640
48 x 72x 29" H	U   Post Combo	LNUC 487229RES	1	2	2-48"	\$4,280	\$4,580	\$5,650
48 x 72x 29" H	Inset U	LNUM 487229RES	1	0	2-24"	\$3,030	\$3,330	\$4,400
48 x 72x 29" H	U Bases	LNUT 487229RES	1	0	3-48"	\$4,950	\$5,250	\$6,320
48 x 72x 36" H	U   Post Combo	LNUC 487236RES	1	2	2-48"	\$4,420	\$4,720	\$5,790
48 x 72x 36" H	Inset U	LNUM 487236RES	1	0	2-24"	\$3,210	\$3,510	\$4,580
48 x 72x 36" H	U Bases	LNUT 487236RES	1	0	3-48"	\$5,130	\$5,430	\$6,500
48 x 72x 42" H	U   Post Combo	LNUC 487242RES	1	2	2-48"	\$4,560	\$4,860	\$5,930
48 x 72x 42" H	Inset U	LNUM 487242RES	1	0	2-24"	\$3,390	\$3,690	\$4,760
48 x 72x 42" H	U Bases	LNUT 487242RES	1	0	3-48"	\$5,310	\$5,610	\$6,680

POWER & A/V OPTIONS SEE PAGES 8-20

TABLE OPTIONS:

Laser cut holes in base - 1.5" x 2.5"  
 Industrial Locking Casters

WB \$100 list per table  
 CS \$70 list per caster



**FINISHES NEEDED:** <http://hi5furniture.com/finishes/>

HPL Top: Hi5 Graded-in laminates or Non-Premium Wilsonart or Formica

Edge Color: Any Hi5 standard

Base Finish: Any Hi5 standard

Table Size	Base Style	Model Code:	# Top Pieces	# of Posts	# of U Bases	List Price	List Price	List Price
48 x 84x 29" H	U   Post Combo	LNUC 488489RES	1	2	2-48"	\$4,480	\$4,840	\$5,920
48 x 84x 29" H	Inset U	LNUM 488489RES	1	0	2-24"	\$3,230	\$3,590	\$4,670
48 x 84x 29" H	U Bases	LNUT 488489RES	1	0	3-48"	\$5,150	\$5,510	\$6,590
48 x 84x 36" H	U   Post Combo	LNUC 488436RES	1	2	2-48"	\$4,620	\$4,980	\$6,060
48 x 84x 36" H	Inset U	LNUM 488436RES	1	0	2-24"	\$3,410	\$3,770	\$4,850
48 x 84x 36" H	U Bases	LNUT 488436RES	1	0	3-48"	\$5,330	\$5,690	\$6,770
48 x 84x 42" H	U   Post Combo	LNUC 488442RES	1	2	2-48"	\$4,760	\$5,120	\$6,200
48 x 84x 42" H	Inset U	LNUM 488442RES	1	0	2-24"	\$3,590	\$3,950	\$5,030
48 x 84x 42" H	U Bases	LNUT 488442RES	1	0	3-48"	\$5,510	\$5,870	\$6,950
48 x 96x 29" H	U   Post Combo	LNUC 489629RES	1	2	2-48"	\$4,500	\$4,865	\$6,000
48 x 96x 29" H	Inset U	LNUM 489629RES	1	0	2-24"	\$3,250	\$3,615	\$4,750
48 x 96x 29" H	U Bases	LNUT 489629RES	1	0	3-48"	\$5,170	\$5,535	\$6,670
48 x 96x 36" H	U   Post Combo	LNUC 489636RES	1	2	2-48"	\$4,640	\$5,005	\$6,140
48 x 96x 36" H	Inset U	LNUM 489636RES	1	0	2-24"	\$3,430	\$3,795	\$4,930
48 x 96x 36" H	U Bases	LNUT 489636RES	1	0	3-48"	\$5,350	\$5,715	\$6,850
48 x 96x 42" H	U   Post Combo	LNUC 489642RES	1	2	2-48"	\$4,780	\$5,145	\$6,280
48 x 96x 42" H	Inset U	LNUM 489642RES	1	0	2-24"	\$3,610	\$3,975	\$5,110
48 x 96x 42" H	U Bases	LNUT 489642RES	1	0	3-48"	\$5,530	\$5,895	\$7,030
48 x 108x 29" H	U   Post Combo	LNUC 4810829RES	1	2	2-48"	\$4,700	\$5,405	\$6,270
48 x 108x 29" H	Inset Combo	LNUM 4810829RES	1	2	2-24"	\$4,100	\$4,805	\$5,670
48 x 108x 29" H	U Bases	LNUT 4810829RES	1	0	3-48"	\$5,370	\$6,075	\$6,940
48 x 108x 36" H	U   Post Combo	LNUC 4810836RES	1	2	2-48"	\$4,840	\$5,545	\$6,410
48 x 108x 36" H	Inset Combo	LNUM 4810836RES	1	2	2-24"	\$4,300	\$5,005	\$5,870
48 x 108x 36" H	U Bases	LNUT 4810836RES	1	0	3-48"	\$5,550	\$6,255	\$7,120
48 x 108x 42" H	U   Post Combo	LNUC 4810842RES	1	2	2-48"	\$4,980	\$5,685	\$6,550
48 x 108x 42" H	Inset Combo	LNUM 4810842RES	1	2	2-24"	\$4,500	\$5,205	\$6,070
48 x 108x 42" H	U Bases	LNUT 4810842RES	1	0	3-48"	\$5,730	\$6,435	\$7,300

POWER & A/V OPTIONS SEE PAGES 8-20

TABLE OPTIONS:

Laser cut holes in base - 1.5" x 2.5"

Industrial Locking Casters







WB

\$100 list per table

CS

\$70 list per caster



			
HPL Top Self edges <b>Suffix L6</b>	HPL Top Wood edges <b>Suffix L20</b>	HPL Top Plywood edges <b>Suffix L17</b>	
			
HPL Top 3mm PVC <b>Suffix L3</b>	HPL Top Knife PVC <b>Suffix L11</b>	HPL Top Knife Wood <b>Suffix L33</b>	HPL Top Knife Plywood <b>Suffix L18</b>

**FINISHES NEEDED:** <http://hi5furniture.com/finishes/>

HPL Top: Hi5 Graded-in laminates or Non-Premium Wilsonart or Formica

Edge Color: Any Hi5 standard

Base Finish: Any Hi5 standard

Table Size	Base Style	Model Code:	# Top Pieces	# of Posts	# of U Bases	List Price	List Price	List Price
48 x 120x 29" H	U   Post Combo	LNU C 4812029RES	1	2	2-48"	\$4,720	\$5,435	\$6,350
48 x 120x 29" H	Inset Combo	LNUM 4812029RES	1	2	2-24"	\$4,120	\$4,835	\$5,750
48 x 120x 29" H	U Bases	LNU T 4812029RES	1	0	3-48"	\$5,390	\$6,105	\$7,020
48 x 120x 36" H	U   Post Combo	LNU C 4812036RES	1	2	2-48"	\$4,860	\$5,575	\$6,490
48 x 120x 36" H	Inset Combo	LNUM 4812036RES	1	2	2-24"	\$4,320	\$5,035	\$5,950
48 x 120x 36" H	U Bases	LNU T 4812036RES	1	0	3-48"	\$5,570	\$6,285	\$7,200
48 x 120x 42" H	U   Post Combo	LNU C 4812042RES	1	2	2-48"	\$5,000	\$5,715	\$6,630
48 x 120x 42" H	Inset Combo	LNUM 4812042RES	1	2	2-24"	\$4,520	\$5,235	\$6,150
48 x 120x 42" H	U Bases	LNU T 4812042RES	1	0	3-48"	\$5,750	\$6,465	\$7,380
48 x 132x 29" H	U   Post Combo	LNU C 4813229RES	2	6	2-48"	\$7,160	\$8,445	\$9,540
48 x 132x 29" H	Inset Combo	LNUM 4813229RES	2	4	2-24"	\$5,910	\$7,195	\$8,290
48 x 132x 29" H	U Bases	LNU T 4813229RES	2	0	5-48"	\$9,170	\$10,455	\$11,550
48 x 132x 36" H	U   Post Combo	LNU C 4813236RES	2	6	2-48"	\$7,340	\$8,625	\$9,720
48 x 132x 36" H	Inset Combo	LNUM 4813236RES	2	4	2-24"	\$6,130	\$7,415	\$8,510
48 x 132x 36" H	U Bases	LNU T 4813236RES	2	0	5-48"	\$9,470	\$10,755	\$11,850
48 x 132x 42" H	U   Post Combo	LNU C 4813242RES	2	6	2-48"	\$7,520	\$8,805	\$9,900
48 x 132x 42" H	Inset Combo	LNUM 4813242RES	2	4	2-24"	\$6,350	\$7,635	\$8,730
48 x 132x 42" H	U Bases	LNU T 4813242RES	2	0	5-48"	\$9,770	\$11,055	\$12,150
48 x 144x 29" H	U   Post Combo	LNU C 4814429RES	2	6	2-48"	\$7,230	\$8,550	\$9,930
48 x 144x 29" H	Inset Combo	LNUM 4814429RES	2	4	2-24"	\$5,980	\$7,300	\$8,680
48 x 144x 29" H	U Bases	LNU T 4814429RES	2	0	5-48"	\$9,240	\$10,560	\$11,940
48 x 144x 36" H	U   Post Combo	LNU C 4814436RES	2	6	2-48"	\$7,410	\$8,730	\$10,110
48 x 144x 36" H	Inset Combo	LNUM 4814436RES	2	4	2-24"	\$6,200	\$7,520	\$8,900
48 x 144x 36" H	U Bases	LNU T 4814436RES	2	0	5-48"	\$9,540	\$10,860	\$12,240
48 x 144x 42" H	U   Post Combo	LNU C 4814442RES	2	6	2-48"	\$7,590	\$8,910	\$10,290
48 x 144x 42" H	Inset Combo	LNUM 4814442RES	2	4	2-24"	\$6,420	\$7,740	\$9,120
48 x 144x 42" H	U Bases	LNU T 4814442RES	2	0	5-48"	\$9,840	\$11,160	\$12,540

POWER & A/V OPTIONS SEE PAGES 8-20

TABLE OPTIONS:

Laser cut holes in base - 1.5" x 2.5"

Industrial Locking Casters

WB

\$100 list per table

CS

\$70 list per caster

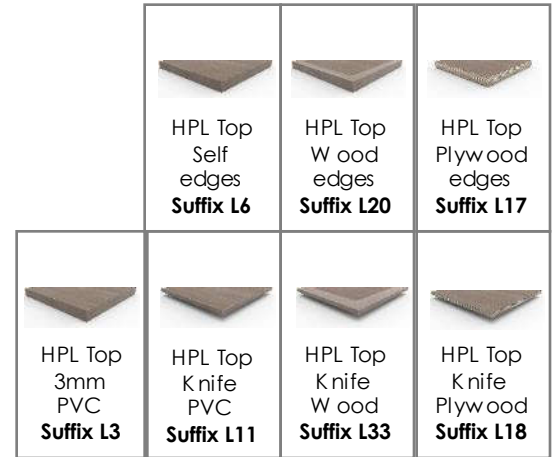

**FINISHES NEEDED:** <http://hi5furniture.com/finishes/>

HPL Top: Hi5 Graded-in laminates or Non-Premium Wilsonart or Formica

Edge Color: Any Hi5 standard

Base Finish: Any Hi5 standard

Table Size	Base Style	Model Code:	# Top Pieces	# of Posts	# of U Bases	List Price	List Price	List Price
48 x 168x 29" H	U   Post Combo	LNUC 4816829RES	2	6	2-48"	\$7,590	\$9,090	\$10,410
48 x 168x 29" H	Inset Combo	LNUM 4816829RES	2	6	2-24"	\$6,990	\$8,490	\$9,810
48 x 168x 29" H	U Bases	LNUT 4816829RES	2	0	5-48"	\$9,600	\$11,100	\$12,420
48 x 168x 36" H	U   Post Combo	LNUC 4816836RES	2	6	2-48"	\$7,770	\$9,270	\$10,590
48 x 168x 36" H	Inset Combo	LNUM 4816836RES	2	6	2-24"	\$7,230	\$8,730	\$10,050
48 x 168x 36" H	U Bases	LNUT 4816836RES	2	0	5-48"	\$9,900	\$11,400	\$12,720
48 x 168x 42" H	U   Post Combo	LNUC 4816842RES	2	6	2-48"	\$7,950	\$9,450	\$10,770
48 x 168x 42" H	Inset Combo	LNUM 4816842RES	2	6	2-24"	\$7,470	\$8,970	\$10,290
48 x 168x 42" H	U Bases	LNUT 4816842RES	2	0	5-48"	\$10,200	\$11,700	\$13,020
48 x 192x 29" H	U   Post Combo	LNUC 4819229RES	2	6	2-48"	\$7,620	\$9,135	\$10,570
48 x 192x 29" H	Inset Combo	LNUM 4819229RES	2	6	2-24"	\$7,020	\$8,535	\$9,970
48 x 192x 29" H	U Bases	LNUT 4819229RES	2	0	5-48"	\$9,630	\$11,145	\$12,580
48 x 192x 36" H	U   Post Combo	LNUC 4819236RES	2	6	2-48"	\$7,800	\$9,315	\$10,750
48 x 192x 36" H	Inset Combo	LNUM 4819236RES	2	6	2-24"	\$7,260	\$8,775	\$10,210
48 x 192x 36" H	U Bases	LNUT 4819236RES	2	0	5-48"	\$9,930	\$11,445	\$12,880
48 x 192x 42" H	U   Post Combo	LNUC 4819242RES	2	6	2-48"	\$7,980	\$9,495	\$10,930
48 x 192x 42" H	Inset Combo	LNUM 4819242RES	2	6	2-24"	\$7,500	\$9,015	\$10,450
48 x 192x 42" H	U Bases	LNUT 4819242RES	2	0	5-48"	\$10,230	\$11,745	\$13,180
48 x 216x 29" H	U   Post Combo	LNUC 4821629RES	2	6	2-48"	\$7,980	\$9,675	\$11,050
48 x 216x 29" H	Inset Combo	LNUM 4821629RES	2	6	2-24"	\$7,380	\$9,075	\$10,450
48 x 216x 29" H	U Bases	LNUT 4821629RES	2	0	5-48"	\$9,990	\$11,685	\$13,060
48 x 216x 36" H	U   Post Combo	LNUC 4821636RES	2	6	2-48"	\$8,160	\$9,855	\$11,230
48 x 216x 36" H	Inset Combo	LNUM 4821636RES	2	6	2-24"	\$7,620	\$9,315	\$10,690
48 x 216x 36" H	U Bases	LNUT 4821636RES	2	0	5-48"	\$10,290	\$11,985	\$13,360
48 x 216x 42" H	U   Post Combo	LNUC 4821642RES	2	6	2-48"	\$8,340	\$10,035	\$11,410
48 x 216x 42" H	Inset Combo	LNUM 4821642RES	2	6	2-24"	\$7,860	\$9,555	\$10,930
48 x 216x 42" H	U Bases	LNUT 4821642RES	2	0	5-48"	\$10,590	\$12,285	\$13,660

POWER & A/V OPTIONS SEE PAGES 8-20

TABLE OPTIONS:

Laser cut holes in base - 1.5" x 2.5"

Industrial Locking Casters

WB

\$100 list per table

CS

\$70 list per caster



**FINISHES NEEDED:** <http://hi5furniture.com/finishes/>

HPL Top: Hi5 Graded-in laminates or Non-Premium Wilsonart or Formica

Edge Color: Any Hi5 standard

Base Finish: Any Hi5 standard

HPL Top Self edges <b>Suffix L6</b>	HPL Top Wood edges <b>Suffix L20</b>	HPL Top Plywood edges <b>Suffix L17</b>	
HPL Top 3mm PVC <b>Suffix L3</b>	HPL Top Knife PVC <b>Suffix L11</b>	HPL Top Knife Wood <b>Suffix L33</b>	HPL Top Knife Plywood <b>Suffix L18</b>

Table Size	Base Style	Model Code:	# Top Pieces	# of Posts	# of U Bases	List Price	List Price	List Price
48 x 240x 29" H	U   Post Combo	LNUC 4824029RES	2	6	2-48"	\$8,010	\$9,720	\$11,200
48 x 240x 29" H	Inset Combo	LNUM 4824029RES	2	6	2-24"	\$7,410	\$9,120	\$10,600
48 x 240x 29" H	U Bases	LNUT 4824029RES	2	0	5-48"	\$10,020	\$11,730	\$13,210
48 x 240x 36" H	U   Post Combo	LNUC 4824036RES	2	6	2-48"	\$8,190	\$9,900	\$11,380
48 x 240x 36" H	Inset Combo	LNUM 4824036RES	2	6	2-24"	\$7,650	\$9,360	\$10,840
48 x 240x 36" H	U Bases	LNUT 4824036RES	2	0	5-48"	\$10,320	\$12,030	\$13,510
48 x 240x 42" H	U   Post Combo	LNUC 4824042RES	2	6	2-48"	\$8,370	\$10,080	\$11,560
48 x 240x 42" H	Inset Combo	LNUM 4824042RES	2	6	2-24"	\$7,890	\$9,600	\$11,080
48 x 240x 42" H	U Bases	LNUT 4824042RES	2	0	5-48"	\$10,620	\$12,330	\$13,810

POWER & A/V OPTIONS SEE PAGES 8-20

TABLE OPTIONS:

Laser cut holes in base - 1.5" x 2.5"

Industrial Locking Casters

WB

\$100 list per table

CS

\$70 list per caster



**FINISHES NEEDED:** <http://hi5furniture.com/finishes/>

HPL Top: Hi5 Graded-in laminates or Non-Premium Wilsonart or Formica

Edge Color: Any Hi5 standard

Base Finish: Any Hi5 standard

Table Size	Base Style	Model Code:	# Top Pieces	# of Posts	# of U Bases	List Price	List Price	List Price
60 x 72x 29" H	U   Post Combo	LNUC 607229RES	1	2	2-60"	\$4,570	\$5,150	\$5,990
60 x 72x 29" H	Inset U	LNUM 607229RES	1	0	2-30"	\$3,320	\$3,900	\$4,740
60 x 72x 29" H	U Bases	LNUT 607229RES	1	0	3-60"	\$5,300	\$5,880	\$6,720
60 x 72x 36" H	U   Post Combo	LNUC 607260RES	1	2	2-60"	\$4,710	\$5,290	\$6,130
60 x 72x 36" H	Inset U	LNUM 607260RES	1	0	2-30"	\$3,500	\$4,080	\$4,920
60 x 72x 36" H	U Bases	LNUT 607260RES	1	0	3-60"	\$5,480	\$6,060	\$6,900
60 x 72x 42" H	U   Post Combo	LNUC 607260RES	1	2	2-60"	\$4,850	\$5,430	\$6,270
60 x 72x 42" H	Inset U	LNUM 607260RES	1	0	2-30"	\$3,680	\$4,260	\$5,100
60 x 72x 42" H	U Bases	LNUT 607260RES	1	0	3-60"	\$5,660	\$6,240	\$7,080
60 x 84x 29" H	U   Post Combo	LNUC 608609RES	1	2	2-60"	\$4,820	\$5,525	\$6,310
60 x 84x 29" H	Inset U	LNUM 608609RES	1	0	2-30"	\$3,570	\$4,275	\$5,060
60 x 84x 29" H	U Bases	LNUT 608609RES	1	0	3-60"	\$5,550	\$6,255	\$7,040
60 x 84x 36" H	U   Post Combo	LNUC 608436RES	1	2	2-60"	\$4,960	\$5,665	\$6,450
60 x 84x 36" H	Inset U	LNUM 608436RES	1	0	2-30"	\$3,750	\$4,455	\$5,240
60 x 84x 36" H	U Bases	LNUT 608436RES	1	0	3-60"	\$5,730	\$6,435	\$7,220
60 x 84x 42" H	U   Post Combo	LNUC 608460RES	1	2	2-60"	\$5,100	\$5,805	\$6,590
60 x 84x 42" H	Inset U	LNUM 608460RES	1	0	2-30"	\$3,930	\$4,635	\$5,420
60 x 84x 42" H	U Bases	LNUT 608460RES	1	0	3-60"	\$5,910	\$6,615	\$7,400
60 x 96x 29" H	U   Post Combo	LNUC 609629RES	1	2	2-60"	\$4,830	\$5,540	\$6,390
60 x 96x 29" H	Inset U	LNUM 609629RES	1	0	2-30"	\$3,580	\$4,290	\$5,140
60 x 96x 29" H	U Bases	LNUT 609629RES	1	0	3-60"	\$5,560	\$6,270	\$7,120
60 x 96x 36" H	U   Post Combo	LNUC 609660RES	1	2	2-60"	\$4,970	\$5,680	\$6,530
60 x 96x 36" H	Inset U	LNUM 609660RES	1	0	2-30"	\$3,760	\$4,470	\$5,320
60 x 96x 36" H	U Bases	LNUT 609660RES	1	0	3-60"	\$5,740	\$6,450	\$7,300
60 x 96x 42" H	U   Post Combo	LNUC 609660RES	1	2	2-60"	\$5,110	\$5,820	\$6,670
60 x 96x 42" H	Inset U	LNUM 609660RES	1	0	2-30"	\$3,940	\$4,650	\$5,500
60 x 96x 42" H	U Bases	LNUT 609660RES	1	0	3-60"	\$5,920	\$6,630	\$7,480

POWER & A/V OPTIONS SEE PAGES 8-20

TABLE OPTIONS:

Laser cut holes in base - 1.5" x 2.5"

Industrial Locking Casters

WB

\$100 list per table

CS

\$70 list per caster



**FINISHES NEEDED:** <http://hi5furniture.com/finishes/>

HPL Top: Hi5 Graded-in laminates or Non-Premium Wilsonart or Formica

Edge Color: Any Hi5 standard

Base Finish: Any Hi5 standard

Table Size	Base Style	Model Code:	# Top Pieces	# of Posts	# of U Bases	List Price	List Price	List Price
60 x 108x 29" H	U   Post Combo	LNUC 6010829RES	1	2	2-60"	\$5,070	\$5,900	\$6,710
60 x 108x 29" H	Inset Combo	LNUM 6010829RES	1	2	2-30"	\$4,470	\$5,300	\$6,110
60 x 108x 29" H	U Bases	LNUT 6010829RES	1	0	3-60"	\$5,800	\$6,630	\$7,440
60 x 108x 36" H	U   Post Combo	LNUC 6010860RES	1	2	2-60"	\$5,210	\$6,040	\$6,850
60 x 108x 36" H	Inset Combo	LNUM 6010860RES	1	2	2-30"	\$4,670	\$5,500	\$6,310
60 x 108x 36" H	U Bases	LNUT 6010860RES	1	0	3-60"	\$5,980	\$6,810	\$7,620
60 x 108x 42" H	U   Post Combo	LNUC 6010860RES	1	2	2-60"	\$5,350	\$6,180	\$6,990
60 x 108x 42" H	Inset Combo	LNUM 6010860RES	1	2	2-30"	\$4,870	\$5,700	\$6,510
60 x 108x 42" H	U Bases	LNUT 6010860RES	1	0	3-60"	\$6,160	\$6,990	\$7,800
60 x 120x 29" H	U   Post Combo	LNUC 6012029RES	1	2	2-60"	\$5,090	\$5,930	\$6,790
60 x 120x 29" H	Inset Combo	LNUM 6012029RES	1	2	2-30"	\$4,490	\$5,330	\$6,190
60 x 120x 29" H	U Bases	LNUT 6012029RES	1	0	3-60"	\$5,820	\$6,660	\$7,520
60 x 120x 36" H	U   Post Combo	LNUC 6012060RES	1	2	2-60"	\$5,230	\$6,070	\$6,930
60 x 120x 36" H	Inset Combo	LNUM 6012060RES	1	2	2-30"	\$4,690	\$5,530	\$6,390
60 x 120x 36" H	U Bases	LNUT 6012060RES	1	0	3-60"	\$6,000	\$6,840	\$7,700
60 x 120x 42" H	U   Post Combo	LNUC 6012060RES	1	2	2-60"	\$5,370	\$6,210	\$7,070
60 x 120x 42" H	Inset Combo	LNUM 6012060RES	1	2	2-30"	\$4,890	\$5,730	\$6,590
60 x 120x 42" H	U Bases	LNUT 6012060RES	1	0	3-60"	\$6,180	\$7,020	\$7,880
60 x 132x 29" H	U   Post Combo	LNUC 6013229RES	2	6	2-60"	\$7,700	\$9,195	\$10,130
60 x 132x 29" H	Inset Combo	LNUM 6013229RES	2	4	2-30"	\$6,450	\$7,945	\$8,880
60 x 132x 29" H	U Bases	LNUT 6013229RES	2	0	5-60"	\$9,890	\$11,385	\$12,320
60 x 132x 36" H	U   Post Combo	LNUC 6013260RES	2	6	2-60"	\$7,880	\$9,375	\$10,310
60 x 132x 36" H	Inset Combo	LNUM 6013260RES	2	4	2-30"	\$6,670	\$8,165	\$9,100
60 x 132x 36" H	U Bases	LNUT 6013260RES	2	0	5-60"	\$10,190	\$11,685	\$12,620
60 x 132x 42" H	U   Post Combo	LNUC 6013260RES	2	6	2-60"	\$8,060	\$9,555	\$10,490
60 x 132x 42" H	Inset Combo	LNUM 6013260RES	2	4	2-30"	\$6,890	\$8,385	\$9,320
60 x 132x 42" H	U Bases	LNUT 6013260RES	2	0	5-60"	\$10,490	\$11,985	\$12,920

POWER & A/V OPTIONS SEE PAGES 8-20

TABLE OPTIONS:

Laser cut holes in base - 1.5" x 2.5"

Industrial Locking Casters

WB

\$100 list per table

CS

\$70 list per caster



HPL Top Self edges <b>Suffix L6</b>	HPL Top Wood edges <b>Suffix L20</b>	HPL Top Plywood edges <b>Suffix L17</b>	
HPL Top 3mm PVC <b>Suffix L3</b>	HPL Top Knife PVC <b>Suffix L11</b>	HPL Top Knife Wood <b>Suffix L33</b>	HPL Top Knife Plywood <b>Suffix L18</b>

**FINISHES NEEDED:** <http://hi5furniture.com/finishes/>  
HPL Top: Hi5 Graded-in laminates or Non-Premium Wilsonart or Formica  
Edge Color: Any Hi5 standard  
Base Finish: Any Hi5 standard

Table Size	Base Style	Model Code:	# Top Pieces	# of Posts	# of U Bases	List Price	List Price	List Price
60 x 144x 29" H	U   Post Combo	LNUC 6014609RES	2	6	2-60"	\$7,790	\$9,330	\$10,600
60 x 144x 29" H	Inset Combo	LNUM 6014609RES	2	4	2-30"	\$6,540	\$8,080	\$9,350
60 x 144x 29" H	U Bases	LNUT 6014609RES	2	0	5-60"	\$9,980	\$11,520	\$12,790
60 x 144x 36" H	U   Post Combo	LNUC 6014460RES	2	6	2-60"	\$7,970	\$9,510	\$10,780
60 x 144x 36" H	Inset Combo	LNUM 6014460RES	2	4	2-30"	\$6,760	\$8,300	\$9,570
60 x 144x 36" H	U Bases	LNUT 6014460RES	2	0	5-60"	\$10,280	\$11,820	\$13,090
60 x 144x 42" H	U   Post Combo	LNUC 6014460RES	2	6	2-60"	\$8,150	\$9,690	\$10,960
60 x 144x 42" H	Inset Combo	LNUM 6014460RES	2	4	2-30"	\$6,980	\$8,520	\$9,790
60 x 144x 42" H	U Bases	LNUT 6014460RES	2	0	5-60"	\$10,580	\$12,120	\$13,390
60 x 168x 29" H	U   Post Combo	LNUC 6016829RES	2	6	2-60"	\$8,240	\$10,005	\$11,160
60 x 168x 29" H	Inset Combo	LNUM 6016829RES	2	6	2-30"	\$7,640	\$9,405	\$10,560
60 x 168x 29" H	U Bases	LNUT 6016829RES	2	0	5-60"	\$10,430	\$12,195	\$13,350
60 x 168x 36" H	U   Post Combo	LNUC 6016860RES	2	6	2-60"	\$8,420	\$10,185	\$11,340
60 x 168x 36" H	Inset Combo	LNUM 6016860RES	2	6	2-30"	\$7,880	\$9,645	\$10,800
60 x 168x 36" H	U Bases	LNUT 6016860RES	2	0	5-60"	\$10,730	\$12,495	\$13,650
60 x 168x 42" H	U   Post Combo	LNUC 6016860RES	2	6	2-60"	\$8,600	\$10,365	\$11,520
60 x 168x 42" H	Inset Combo	LNUM 6016860RES	2	6	2-30"	\$8,120	\$9,885	\$11,040
60 x 168x 42" H	U Bases	LNUT 6016860RES	2	0	5-60"	\$11,030	\$12,795	\$13,950
60 x 192x 29" H	U   Post Combo	LNUC 6019229RES	2	6	2-60"	\$8,270	\$10,050	\$11,310
60 x 192x 29" H	Inset Combo	LNUM 6019229RES	2	6	2-30"	\$7,670	\$9,450	\$10,710
60 x 192x 29" H	U Bases	LNUT 6019229RES	2	0	5-60"	\$10,460	\$12,240	\$13,500
60 x 192x 36" H	U   Post Combo	LNUC 6019260RES	2	6	2-60"	\$8,450	\$10,230	\$11,490
60 x 192x 36" H	Inset Combo	LNUM 6019260RES	2	6	2-30"	\$7,910	\$9,690	\$10,950
60 x 192x 36" H	U Bases	LNUT 6019260RES	2	0	5-60"	\$10,760	\$12,540	\$13,800
60 x 192x 42" H	U   Post Combo	LNUC 6019260RES	2	6	2-60"	\$8,630	\$10,410	\$11,670
60 x 192x 42" H	Inset Combo	LNUM 6019260RES	2	6	2-30"	\$8,150	\$9,930	\$11,190
60 x 192x 42" H	U Bases	LNUT 6019260RES	2	0	5-60"	\$11,060	\$12,840	\$14,100

POWER & A/V OPTIONS SEE PAGES 8-20

TABLE OPTIONS:

Laser cut holes in base - 1.5" x 2.5"  
Industrial Locking Casters

WB \$100 list per table  
CS \$70 list per caster





**FINISHES NEEDED:** <http://hi5furniture.com/finishes/>

HPL Top: Hi5 Graded-in laminates or Non-Premium Wilsonart or Formica

Edge Color: Any Hi5 standard

Base Finish: Any Hi5 standard







			
HPL Top Self edges <b>Suffix L6</b>	HPL Top Wood edges <b>Suffix L20</b>	HPL Top Plywood edges <b>Suffix L17</b>	
			
HPL Top 3mm PVC <b>Suffix L3</b>	HPL Top Knife PVC <b>Suffix L11</b>	HPL Top Knife Wood <b>Suffix L33</b>	HPL Top Knife Plywood <b>Suffix L18</b>

Table Size	Base Style	Model Code:	# Top Pieces	# of Posts	# of U Bases	List Price	List Price	List Price
60 x 216x 29" H	U   Post Combo	LNUC 6021629RES	2	6	2-60"	\$8,720	\$10,725	\$11,870
60 x 216x 29" H	Inset Combo	LNUM 6021629RES	2	6	2-30"	\$8,120	\$10,125	\$11,270
60 x 216x 29" H	U Bases	LNUT 6021629RES	2	0	5-60"	\$10,910	\$12,915	\$14,060
60 x 216x 36" H	U   Post Combo	LNUC 6021660RES	2	6	2-60"	\$8,900	\$10,905	\$12,050
60 x 216x 36" H	Inset Combo	LNUM 6021660RES	2	6	2-30"	\$8,360	\$10,365	\$11,510
60 x 216x 36" H	U Bases	LNUT 6021660RES	2	0	5-60"	\$11,210	\$13,215	\$14,360
60 x 216x 42" H	U   Post Combo	LNUC 6021660RES	2	6	2-60"	\$9,080	\$11,085	\$12,230
60 x 216x 42" H	Inset Combo	LNUM 6021660RES	2	6	2-30"	\$8,600	\$10,605	\$11,750
60 x 216x 42" H	U Bases	LNUT 6021660RES	2	0	5-60"	\$11,510	\$13,515	\$14,660
60 x 240x 29" H	U   Post Combo	LNUC 6024029RES	2	6	2-60"	\$8,750	\$10,770	\$12,030
60 x 240x 29" H	Inset Combo	LNUM 6024029RES	2	6	2-30"	\$8,150	\$10,170	\$11,430
60 x 240x 29" H	U Bases	LNUT 6024029RES	2	0	5-60"	\$10,940	\$12,960	\$14,220
60 x 240x 36" H	U   Post Combo	LNUC 6024060RES	2	6	2-60"	\$8,930	\$10,950	\$12,210
60 x 240x 36" H	Inset Combo	LNUM 6024060RES	2	6	2-30"	\$8,390	\$10,410	\$11,670
60 x 240x 36" H	U Bases	LNUT 6024060RES	2	0	5-60"	\$11,240	\$13,260	\$14,520
60 x 240x 42" H	U   Post Combo	LNUC 6024060RES	2	6	2-60"	\$9,110	\$11,130	\$12,390
60 x 240x 42" H	Inset Combo	LNUM 6024060RES	2	6	2-30"	\$8,630	\$10,650	\$11,910
60 x 240x 42" H	U Bases	LNUT 6024060RES	2	0	5-60"	\$11,540	\$13,560	\$14,820

POWER & A/V OPTIONS SEE PAGES 8-20

TABLE OPTIONS:

Laser cut holes in base - 1.5" x 2.5"

Industrial Locking Casters

WB

\$100 list per table

CS

\$70 list per caster



## RECTANGLE TABLES

Table Size	Model Code	With Out Toe Kick	With 2" Toe Kick
12 x 48 x 18h	OR1248-18H.L	2355	3070
12 x 48 x 24"h	OR1248-24H.L	2555	3205
12 x 48 x 30"h	OR1248-30H.L	2755	3950
18 x 30 x 18h	OR1830-18H.L	2355	2775
18 x 36 x 18h	OR1836-18H.L	1915	2445
18 x 48 x 18h	OR1848-18H.L	2955	3595
18 x 60 x 18h	OR1860-18H.L	3950	4725
18 x 30 x 24h	OR1830-24H.L	2600	3040
18 x 36 x 24h	OR1836-24H.L	2820	3350
18 x 48 x 24h	OR1848-24H.L	3380	4020
18 x 60 x 24h	OR1860-24H.L	4050	4825
18 x 30 x 30h	OR1830-30H.L	2745	3185
18 x 36 x 30h	OR1836-30H.L	3000	3530
18 x 48 x 30h	OR1848-30H.L	3855	4495
18 x 60 x 30h	OR1860-30H.L	4320	5095
24 x 36 x 18h	OR2436-18H.L	2505	3095
24 x 48 x 18h	OR2448-18H.L	3045	3790
24 x 60 x 18h	OR2460-18H.L	4070	4970
24 x 36 x 24h	OR2436-24H.L	3375	3965
24 x 48 x 24h	OR2448-24H.L	3925	4670
24 x 60 x 24h	OR2460-24H.L	4250	5150
24 x 36 x 30h	OR2436-30H.L	3855	4445
24 x 48 x 30h	OR2448-30H.L	4240	4985
24 x 60 x 30h	OR2460-30H.L	4590	5490
30 x 48 x 18h	OR3048-18H.L	4200	5035
30 x 60 x 18h	OR3060-18H.L	4640	5650
30 x 48 x 24h	OR3048-24H.L	4275	5110
30 x 60 x 24h	OR3060-24H.L	4755	5765
30 x 48 x 30h	OR3048-30H.L	4735	5570
30 x 60 x 30h	OR3060-30H.L	6200	7210
36 x 48 x 18"h	OR3648-18H.L	4470	5325
36 x 48 x 24"h	OR3648-24H.L	4675	5530
36 x 48 x 30"h	OR3648-30H.L	5005	5860
48 x 60 x 18"h	OR4860-18H.L	5070	6100
48 x 60 x 24"h	OR4860-24H.L	5526	6556
48 x 60 x 30"h	OR4860-30H.L	6520	7550

**AS OF 2021  
PRODUCT UPDATE  
See Hi5Furniture.com  
For Offering & Pricing**

Toe Kick:

Add -TK to end of model code to add the toe kick

## ROUND TABLES

Table Size	Model Code	With Out Toe Kick	With 2" Toe Kick
18 x 18h	OC18-18H.L	1245	1625
18 x 24h	OC18-24H.L	1275	1655
18 x 30h	OC18-30H.L	1375	1755
24 x 18h	OC24-18H.L	1420	1890
24 x 24h	OC24-24H.L	1495	1965
24 x 30h	OC24-30H.L	1840	2310
30 x 18h	OC30-18H.L	1700	2085
30 x 24h	OC30-24H.L	1780	2360
30 x 30h	OC30-30H.L	2205	2785
36 x 18h	OC36-18H.L	2445	3145
36 x 24h	OC36-24H.L	2570	3270
36 x 30h	OC36-30H.L	2910	3610

## SQUARE TABLES

Table Size	Model Code	With Out Toe Kick	With 2" Toe Kick
18 x 18h	OS18-18H.L	1350	1790
18 x 24h	OS18-24H.L	1410	1850
18 x 30h	OS18-30H.L	1740	2180
24 x 18h	OS24-18H.L	1720	2220
24 x 24h	OS24-24H.L	1735	2235
24 x 30h	OS24-30H.L	1875	2375
30 x 18h	OS30-18H.L	1880	2535
30 x 24h	OS30-24H.L	1960	2615
30 x 30h	OS30-30H.L	2250	2905
36 x 18h	OS36-18H.L	2450	3105
36 x 24h	OS36-24H.L	2875	3530
36 x 30h	OS36-30H.L	3045	3700

## Cube Bases

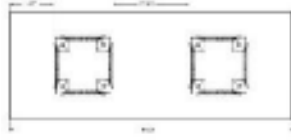

36 x 96



48 x 96

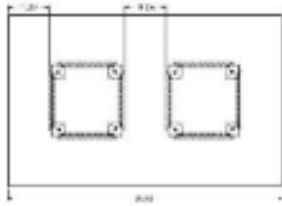

60 x 96

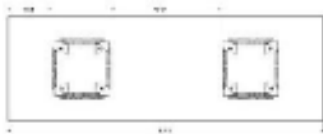

36 x 108



48 x 108

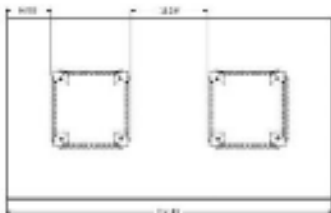

60 x 108



36 x 120

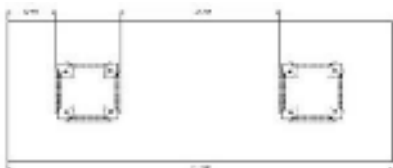

48 x 120

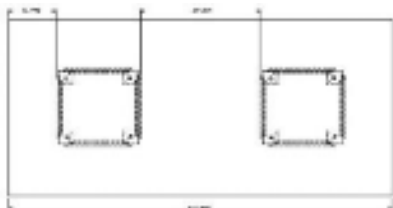

60 x 120

## Panel Bases

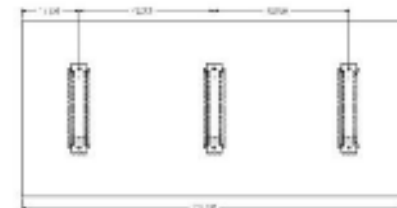
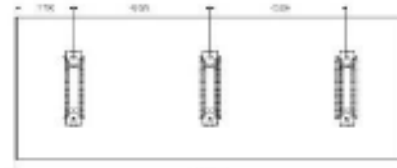
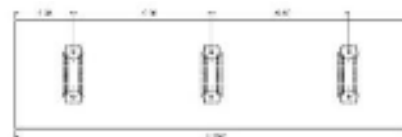
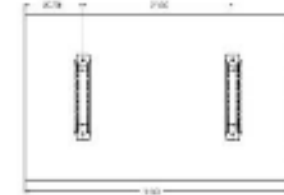
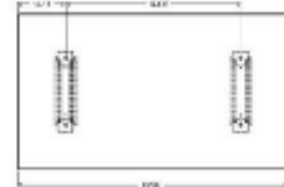



Cube Bases

**FINISHES NEEDED:** <http://hi5furniture.com/finishes/>

HPL Top: Hi5 Graded-in laminates or Non-Premium Wilsonart or Formica

Edge Color: Any Hi5 standard

Base Finish: Any Hi5 standard

HPL Top Self edges <b>Suffix L6</b>	HPL Top Wood edges <b>Suffix L20</b>	HPL Top Plywood edges <b>Suffix L17</b>	
HPL Top 3mm PVC <b>Suffix L3</b>	HPL Top Knife PVC <b>Suffix L11</b>	HPL Top Knife Wood <b>Suffix L33</b>	HPL Top Knife Plywood <b>Suffix L18</b>

Table Size	Table Shape	Base Shape	Model Code:	Top QTY	Base QTY	Base Size			
24 x 29" H	square	cube	RYCL2429SQS	1	1	18"	\$3,425	\$3,485	\$3,560
30 x 29" H	square	cube	RYCL3029SQS	1	1	18"	\$3,500	\$3,565	\$3,820
36 x 29" H	square	cube	RYCL3629SQS	1	1	18"	\$3,570	\$3,640	\$4,150
42 x 29" H	round	cube	RYCL4229RDS	1	1	18"	\$3,655	\$3,790	\$4,775
42 x 29" H	square	cube	RYCL4229SQS	1	1	18"	\$3,595	\$3,680	\$4,670
48 x 29" H	round	cube	RYCL4829RDS	1	1	18"	\$3,665	\$3,800	\$5,155
48 x 29" H	square	cube	RYCL4829SQS	1	1	24"	\$3,740	\$3,830	\$5,110
54 x 29" H	round	cube	RYCL5429RDS	1	1	24"	\$4,020	\$4,180	\$6,010
54 x 29" H	square	cube	RYCL5429SQS	1	1	30"	\$4,100	\$4,210	\$6,365
60 x 29" H	round	cube	RYCL6029RDS	1	1	24"	\$4,040	\$4,190	\$6,455
60 x 29" H	square	cube	RYCL6029SQS	1	1	30"	\$4,105	\$4,225	\$6,370
72 x 29" H	round	cube	RYCL7229RDS	2	1	30"	\$5,285	\$5,580	\$8,335

POWER & A/V OPTIONS SEE PAGES 8-20

**TABLE OPTIONS**

Custom Stain for wood edges	UCS	\$600 per color
Non-powered round ABS plastic Grommet (black or silver)	G (B/S)	\$20 per grommet
Non-powered rectangle metal Grommet (black or silver)	GV (B/S)	\$120 per grommet
Customer specified hole cut into top	CNC	\$250 set up fee per template
36" long Horizontal 4 track Extruded Raceway	WH	\$80 per piece
Horizontal conference Wire Management Trough	WT	\$475 per table



Panel Base



Cube Bases



Rectangle Base

HPL Top Self edges <b>Suffix L6</b>	HPL Top Wood edges <b>Suffix L20</b>	HPL Top Plywood edges <b>Suffix L17</b>

**FINISHES NEEDED:** <http://hi5furniture.com/finishes/>

HPL Top: Hi5 Graded-in laminates or Non-Premium Wilsonart or Formica

Edge Color: Any Hi5 standard

Base Finish: Any Hi5 standard

HPL Top 3mm PVC <b>Suffix L3</b>	HPL Top Knife PVC <b>Suffix L11</b>	HPL Top Knife Wood <b>Suffix L33</b>	HPL Top Knife Plywood <b>Suffix L18</b>

Table Size	Table Shape	Base Shape	Model Code:	Top QTY	Base QTY	Base Size			
36 x 72x 29" H	rectangle	cube	RYCL367229RES	1	2	18"	\$6,685	\$7,040	\$8,310
36 x 72x 29" H	rectangle	panel	RYPL367229RES	1	2	18"	\$3,670	\$3,785	\$5,060
36 x 72x 29" H	any shape	cube	RYCL367229??S	1	2	18"	\$6,925	\$7,040	\$2,130
36 x 72x 29" H	any shape	panel	RYPL367229??S	1	2	18"	\$3,670	\$7,385	\$5,360
36 x 84x 29" H	rectangle	panel	RYPL368429RES	1	2	18"	\$3,990	\$4,140	\$5,820
36 x 84x 29" H	rectangle	cube	RYCL368429RES	1	2	18"	\$7,175	\$7,325	\$9,005
36 x 84x 29" H	any shape	cube	RYCL368429??S	1	2	18"	\$7,175	\$7,325	\$9,305
36 x 84x 29" H	any shape	panel	RYPL368429??S	1	2	18"	\$3,990	\$4,140	\$6,120
36 x 96x 29" H	any shape	cube	RYCL369629??S	1	2	18"	\$7,190	\$7,345	\$9,320
36 x 96x 29" H	any shape	panel	RYPL369629??S	1	2	18"	\$4,070	\$4,225	\$6,200
36 x 96x 29" H	rectangle	panel	RYPL369629RES	1	2	18"	\$4,070	\$4,225	\$5,915
36 x 96x 29" H	rectangle	cube	RYCL369629RES	1	2	18"	\$7,190	\$7,345	\$9,035
36 x 108x 29" H	any shape	cube	RYCL3610829??S	1	2	18"	\$7,410	\$7,600	\$10,075
36 x 108x 29" H	any shape	panel	RYPL3610829??S	1	2	18"	\$4,355	\$4,550	\$7,020
36 x 108x 29" H	rectangle	panel	RYPL3610829RES	1	2	18"	\$4,355	\$4,550	\$6,720
36 x 108x 29" H	rectangle	cube	RYCL3610829RES	1	2	18"	\$7,410	\$7,600	\$9,775
36 x 120x 29" H	any shape	cube	RYCL3612029??S	1	2	18"	\$7,410	\$7,600	\$10,075
36 x 120x 29" H	any shape	panel	RYPL3612029??S	1	2	18"	\$4,420	\$4,615	\$7,085
36 x 120x 29" H	rectangle	cube	RYCL3612029RES	1	2	18"	\$7,410	\$7,600	\$9,775
36 x 120x 29" H	rectangle	panel	RYPL3612029RES	1	2	18"	\$4,420	\$4,615	\$6,785

POWER & A/V OPTIONS SEE PAGES 8-20

**TABLE OPTIONS**

Custom Stain for wood edges	UCS	\$600 per color
Non-powered round ABS plastic Grommet (black or silver)	G (B/S)	\$20 per grommet
Non-powered rectangle metal Grommet (black or silver)	GV (B/S)	\$120 per grommet
Customer specified hole cut into top	CNC	\$250 set up fee per template
36" long Horizontal 4 track Extruded Raceway	WH	\$80 per piece
Horizontal conference Wire Management Trough	WT	\$475 per table



Panel Base



Cube Bases



Rectangle Base

HPL Top Self edges <b>Suffix L6</b>	HPL Top Wood edges <b>Suffix L20</b>	HPL Top Plywood edges <b>Suffix L17</b>

**FINISHES NEEDED:** <http://hi5furniture.com/finishes/>

HPL Top: Hi5 Graded-in laminates or Non-Premium Wilsonart or Formica

Edge Color: Any Hi5 standard

Base Finish: Any Hi5 standard

HPL Top 3mm PVC <b>Suffix L3</b>	HPL Top Knife PVC <b>Suffix L11</b>	HPL Top Knife Wood <b>Suffix L33</b>	HPL Top Knife Plywood <b>Suffix L18</b>

Table Size	Table Shape	Base Shape	Model Code:	Top QTY	Base QTY	Base Size			
48 x 72x 29" H	any shape	cube	RYCL487229??S	1	2	18"	\$7,045	\$7,175	\$9,355
48 x 72x 29" H	any shape	panel	RYPL487229??S	1	2	24"	\$3,955	\$4,085	\$6,265
48 x 72x 29" H	rectangle	cube	RYCL487229RES	1	2	18"	\$6,935	\$7,055	\$8,935
48 x 72x 29" H	rectangle	panel	RYPL487229RES	1	2	24"	\$3,845	\$3,965	\$5,965
48 x 84x 29" H	any shape	cube	RYCL488429??S	1	2	18"	\$7,290	\$7,460	\$10,620
48 x 84x 29" H	any shape	panel	RYPL488429??S	1	2	24"	\$4,265	\$4,435	\$7,595
48 x 84x 29" H	rectangle	cube	RYCL488429RES	1	2	18"	\$7,190	\$7,345	\$10,020
48 x 84x 29" H	rectangle	panel	RYPL488429RES	1	2	24"	\$4,165	\$4,320	\$6,995
48 x 96x 29" H	any shape	cube	RYCL489629??S	1	2	18"	\$7,295	\$7,470	\$10,630
48 x 96x 29" H	any shape	panel	RYPL489629??S	1	2	24"	\$4,340	\$4,510	\$7,675
48 x 96x 29" H	any shape	rectangle	RYRL489629??S	1	1	18" x 50"	\$6,770	\$6,940	\$10,105
48 x 96x 29" H	rectangle	cube	RYCL489629RES	1	2	18"	\$7,265	\$7,370	\$10,030
48 x 96x 29" H	rectangle	rectangle	RYRL489629RES	1	1	18" x 50"	\$6,680	\$6,840	\$9,505
48 x 96x 29" H	rectangle	panel	RYPL489629RES	1	2	24"	\$4,250	\$4,410	\$7,075
48 x 108x 29" H	any shape	cube	RYCL4810829??S	1	2	18"	\$7,510	\$7,715	\$11,580
48 x 108x 29" H	any shape	panel	RYPL4810829??S	1	2	24"	\$4,620	\$4,825	\$8,690
48 x 108x 29" H	any shape	rectangle	RYRL4810829??S	1	1	18" x 75"	\$9,490	\$9,695	\$13,560
48 x 108x 29" H	rectangle	cube	RYCL4810829RES	1	2	18"	\$2,010	\$7,600	\$10,980
48 x 108x 29" H	rectangle	panel	RYPL4810829RES	1	2	24"	\$4,520	\$4,710	\$8,090
48 x 108x 29" H	rectangle	rectangle	RYRL4810829RES	1	1	18" x 75"	\$9,390	\$9,580	\$12,960
48 x 120x 29" H	any shape	cube	RYCL4812029??S	1	2	18"	\$7,510	\$7,715	\$11,580
48 x 120x 29" H	any shape	panel	RYPL4812029??S	1	2	24"	\$4,700	\$4,900	\$8,780
48 x 120x 29" H	any shape	rectangle	RYRL4812029??S	1	1	18" x 75"	\$9,505	\$9,710	\$13,585
48 x 120x 29" H	rectangle	cube	RYCL4812029RES	1	2	18"	\$7,430	\$7,620	\$10,990
48 x 120x 29" H	rectangle	panel	RYPL4812029RES	1	2	24"	\$4,600	\$4,795	\$8,165
48 x 120x 29" H	rectangle	rectangle	RYRL4812029RES	1	1	18" x 75"	\$9,410	\$9,600	\$12,970



Panel Base



Cube Bases



Rectangle Base

HPL Top Self edges <b>Suffix L6</b>	HPL Top Wood edges <b>Suffix L20</b>	HPL Top Plywood edges <b>Suffix L17</b>

**FINISHES NEEDED:** <http://hi5furniture.com/finishes/>

HPL Top: Hi5 Graded-in laminates or Non-Premium Wilsonart or Formica

Edge Color: Any Hi5 standard

Base Finish: Any Hi5 standard

HPL Top 3mm PVC <b>Suffix L3</b>	HPL Top Knife PVC <b>Suffix L11</b>	HPL Top Knife Wood <b>Suffix L33</b>	HPL Top Knife Plywood <b>Suffix L18</b>

Table Size	Table Shape	Base Shape	Model Code:	Top QTY	Base QTY	Base Size			
48 x 144x 29" H	any shape	cube	RYCL4814429??S	2	3	18"	\$10,830	\$11,065	\$15,655
48 x 144x 29" H	any shape	panel	RYPL4814429??S	2	3	24"	\$6,470	\$6,700	\$11,290
48 x 144x 29" H	any shape	rectangle	RYRL4814429??S	2	1	18" x 100"	\$12,240	\$12,475	\$17,065
48 x 144x 29" H	rectangle	cube	RYCL4814429RES	2	3	18"	\$10,730	\$10,950	\$14,935
48 x 144x 29" H	rectangle	panel	RYPL4814429RES	2	3	24"	\$6,385	\$6,590	\$10,690
48 x 144x 29" H	rectangle	rectangle	RYRL4814429RES	2	1	18" x 100"	\$12,140	\$12,360	\$16,465
48 x 168x 29" H	any shape	cube	RYCL4816829??S	2	3	18"	\$11,570	\$11,670	\$16,595
48 x 168x 29" H	any shape	panel	RYPL4816829??S	2	3	24"	\$7,340	\$7,440	\$12,365
48 x 168x 29" H	any shape	rectangle	RYRL4816829??S	2	1	18" x 125"	\$15,485	\$15,590	\$20,515
48 x 168x 29" H	rectangle	cube	RYCL4816829RES	2	3	18"	\$11,515	\$11,855	\$15,990
48 x 168x 29" H	rectangle	panel	RYPL4816829RES	2	3	24"	\$7,285	\$7,625	\$11,760
48 x 168x 29" H	rectangle	rectangle	RYRL4816829RES	2	1	18" x 125"	\$15,430	\$15,775	\$19,910
48 x 192x 29" H	any shape	cube	RYCL4819229??S	2	3	18"	\$11,570	\$11,670	\$16,595
48 x 192x 29" H	any shape	panel	RYPL4819229??S	2	3	24"	\$7,340	\$7,440	\$12,365
48 x 192x 29" H	any shape	rectangle	RYRL4819229??S	2	1	18" x 150"	\$15,485	\$15,590	\$20,515
48 x 192x 29" H	rectangle	cube	RYCL4819229RES	2	3	18"	\$11,550	\$11,900	\$16,955
48 x 192x 29" H	rectangle	panel	RYPL4819229RES	2	3	24"	\$7,450	\$7,800	\$12,860
48 x 192x 29" H	rectangle	rectangle	RYRL4819229RES	2	1	18" x 150"	\$17,975	\$18,325	\$23,380
48 x 228x 29" H	any shape	cube	RYCL4822829??S	2	4	18"	\$15,160	\$15,590	\$22,585
48 x 228x 29" H	any shape	panel	RYPL4822829??S	2	4	24"	\$9,665	\$10,090	\$17,090
48 x 228x 29" H	any shape	rectangle	RYRL4822829??S	2	1	18" x 175"	\$23,525	\$23,950	\$30,455
48 x 228x 29" H	rectangle	cube	RYCL4822829RES	2	4	18"	\$15,145	\$15,565	\$22,090
48 x 228x 29" H	rectangle	panel	RYPL4822829RES	2	4	24"	\$9,650	\$10,070	\$16,595
48 x 228x 29" H	rectangle	rectangle	RYRL4822829RES	2	1	18" x 175"	\$23,510	\$23,930	\$30,455

POWER & A/V OPTIONS SEE PAGES 8-20

**TABLE OPTIONS**

Custom Stain for wood edges	UCS	\$600 per color
Non-powered round ABS plastic Grommet (black or silver)	G (B/S)	\$20 per grommet
Non-powered rectangle metal Grommet (black or silver)	GV (B/S)	\$120 per grommet
Customer specified hole cut into top	CNC	\$250 set up fee per template
36" long Horizontal 4 track Extruded Raceway	WH	\$80 per piece
Horizontal conference Wire Management Trough	WT	\$475 per table



Panel Base



Cube Bases



Rectangle Base

HPL Top Self edges <b>Suffix L6</b>	HPL Top Wood edges <b>Suffix L20</b>	HPL Top Plywood edges <b>Suffix L17</b>

**FINISHES NEEDED:** <http://hi5furniture.com/finishes/>

HPL Top: Hi5 Graded-in laminates or Non-Premium Wilsonart or Formica

Edge Color: Any Hi5 standard

Base Finish: Any Hi5 standard

HPL Top 3mm PVC <b>Suffix L3</b>	HPL Top Knife PVC <b>Suffix L11</b>	HPL Top Knife Wood <b>Suffix L33</b>	HPL Top Knife Plywood <b>Suffix L18</b>

Table Size	Table Shape	Base Shape	Model Code:	Top QTY	Base QTY	Base Size			
60 x 72x 29" H	any shape	cube	RYCL607229??S	1	2	24"	\$7,460	\$7,615	\$10,345
60 x 72x 29" H	any shape	panel	RYPL607229??S	1	2	30"	\$4,260	\$4,415	\$7,145
60 x 72x 29" H	rectangle	cube	RYCL607229RES	1	2	24"	\$7,360	\$7,505	\$10,040
60 x 72x 29" H	rectangle	panel	RYPL607229RES	1	2	30"	\$4,165	\$4,310	\$6,840
60 x 84x 29" H	any shape	cube	RYCL608429??S	1	2	24"	\$7,750	\$7,950	\$11,845
60 x 84x 29" H	any shape	panel	RYPL608429??S	1	2	30"	\$4,620	\$4,820	\$8,710
60 x 84x 29" H	rectangle	cube	RYCL608429RES	1	2	24"	\$7,655	\$7,850	\$11,245
60 x 84x 29" H	rectangle	panel	RYPL608429RES	1	2	30"	\$4,525	\$11,195	\$8,110
60 x 96x 29" H	any shape	cube	RYCL609629??S	1	2	24"	\$7,760	\$7,960	\$11,870
60 x 96x 29" H	any shape	panel	RYPL609629??S	1	2	30"	\$4,690	\$4,895	\$8,800
60 x 96x 29" H	any shape	rectangle	RYRL609629??S	1	1	24" x 50"	\$7,030	\$7,235	\$11,140
60 x 96x 29" H	rectangle	cube	RYCL609629RES	1	2	24"	\$7,675	\$7,865	\$11,255
60 x 96x 29" H	rectangle	panel	RYPL609629RES	1	2	30"	\$4,610	\$4,800	\$8,190
60 x 96x 29" H	rectangle	rectangle	RYRL609629RES	1	1	24" x 50"	\$6,950	\$7,140	\$10,530
60 x 108x 29" H	any shape	cube	RYCL6010829??S	1	2	24"	\$8,020	\$8,260	\$13,055
60 x 108x 29" H	any shape	panel	RYPL6010829??S	1	2	30"	\$5,020	\$5,260	\$10,055
60 x 108x 29" H	any shape	rectangle	RYRL6010829??S	1	1	24" x 75"	\$9,805	\$10,045	\$14,840
60 x 108x 29" H	rectangle	cube	RYCL6010829RES	1	2	24"	\$7,925	\$8,155	\$12,450
60 x 108x 29" H	rectangle	panel	RYPL6010829RES	1	2	30"	\$4,925	\$5,155	\$9,450
60 x 108x 29" H	rectangle	rectangle	RYRL6010829RES	1	1	24" x 75"	\$9,710	\$9,935	\$14,230
60 x 120x 29" H	any shape	cube	RYCL6012029??S	1	2	24"	\$8,030	\$8,275	\$13,080
60 x 120x 29" H	any shape	panel	RYPL6012029??S	1	2	30"	\$5,095	\$5,340	\$10,145
60 x 120x 29" H	any shape	rectangle	RYRL6012029??S	1	1	24" x 75"	\$9,810	\$10,055	\$14,860
60 x 120x 29" H	rectangle	cube	RYCL6012029RES	1	2	24"	\$7,945	\$8,170	\$12,455
60 x 120x 29" H	rectangle	panel	RYPL6012029RES	1	2	30"	\$5,010	\$5,240	\$9,520
60 x 120x 29" H	rectangle	rectangle	RYRL6012029RES	1	1	24" x 75"	\$9,725	\$9,955	\$14,240





Panel Base



Cube Bases



Rectangle Base

HPL Top Self edges <b>Suffix L6</b>	HPL Top Wood edges <b>Suffix L20</b>	HPL Top Plywood edges <b>Suffix L17</b>

HPL Top 3mm PVC <b>Suffix L3</b>	HPL Top Knife PVC <b>Suffix L11</b>	HPL Top Knife Wood <b>Suffix L33</b>	HPL Top Knife Plywood <b>Suffix L18</b>

**FINISHES NEEDED:** <http://hi5furniture.com/finishes/>

HPL Top: Hi5 Graded-in laminates or Non-Premium Wilsonart or Formica

Edge Color: Any Hi5 standard

Base Finish: Any Hi5 standard

Table Size	Table Shape	Base Shape	Model Code:	Top QTY	Base QTY	Base Size			
60 x 144x 29" H	any shape	cube	RYCL6014429??S	2	3	24"	\$11,515	\$11,795	\$17,490
60 x 144x 29" H	any shape	panel	RYPL6014429??S	2	3	30"	\$6,995	\$7,280	\$12,970
60 x 144x 29" H	any shape	rectangle	RYRL6014429??S	2	1	24" x 100"	\$12,595	\$12,875	\$18,570
60 x 144x 29" H	rectangle	cube	RYCL6014429RES	2	3	24"	\$11,420	\$11,690	\$16,890
60 x 144x 29" H	rectangle	panel	RYPL6014429RES	2	3	30"	\$6,900	\$7,170	\$12,370
60 x 144x 29" H	rectangle	rectangle	RYRL6014429RES	2	1	24" x 100"	\$12,500	\$12,770	\$17,970
60 x 168x 29" H	any shape	panel	RYPL6016829??S	2	3	30"	\$8,005	\$8,410	\$14,290
60 x 168x 29" H	any shape	cube	RYCL6016829??S	2	3	24"	\$12,390	\$12,800	\$18,680
60 x 168x 29" H	any shape	rectangle	RYRL6016829??S	2	1	24" x 125"	\$15,980	\$16,385	\$22,265
60 x 168x 29" H	rectangle	cube	RYCL6016829RES	2	3	24"	\$12,340	\$12,750	\$18,070
60 x 168x 29" H	rectangle	panel	RYPL6016829RES	2	3	30"	\$7,955	\$8,365	\$13,685
60 x 168x 29" H	rectangle	rectangle	RYRL6016829RES	2	1	24" x 125"	\$15,930	\$16,340	\$21,660
60 x 192x 29" H	any shape	cube	RYCL6019229??S	2	3	24"	\$12,425	\$12,845	\$19,885
60 x 192x 29" H	any shape	panel	RYPL6019229??S	2	3	30"	\$8,170	\$8,590	\$15,630
60 x 192x 29" H	any shape	rectangle	RYRL6019229??S	2	1	24" x 150"	\$18,520	\$18,940	\$25,980
60 x 192x 29" H	rectangle	cube	RYCL6019229RES	2	3	24"	\$12,380	\$12,785	\$19,285
60 x 192x 29" H	rectangle	panel	RYPL6019229RES	2	3	30"	\$8,125	\$8,530	\$15,030
60 x 192x 29" H	rectangle	rectangle	RYRL6019229RES	2	1	24" x 150"	\$18,475	\$18,880	\$25,380
60 x 228x 29" H	any shape	cube	RYCL6022829??S	2	4	24"	\$16,220	\$16,720	\$25,505
60 x 228x 29" H	any shape	panel	RYPL6022829??S	2	4	30"	\$10,505	\$11,010	\$19,795
60 x 228x 29" H	any shape	rectangle	RYRL6022829??S	2	1	24" x 175"	\$24,120	\$24,625	\$33,410
60 x 228x 29" H	rectangle	cube	RYCL6022829RES	2	4	24"	\$16,200	\$16,710	\$24,905
60 x 228x 29" H	rectangle	panel	RYPL6022829RES	2	4	30"	\$10,490	\$11,000	\$19,195
60 x 228x 29" H	rectangle	rectangle	RYRL6022829RES	2	1	24" x 175"	\$24,100	\$24,610	\$32,810

POWER & A/V OPTIONS SEE PAGES 8-20

**TABLE OPTIONS**

Custom Stain for wood edges	UCS	\$600 per color
Non-powered round ABS plastic Grommet (black or silver)	G (B/S)	\$20 per grommet
Non-powered rectangle metal Grommet (black or silver)	GV (B/S)	\$120 per grommet
Customer specified hole cut into top	CNC	\$250 set up fee per template
36" long Horizontal 4 track Extruded Raceway	WH	\$80 per piece
Horizontal conference Wire Management Trough	WT	\$475 per table

## POWER & A/V OPTIONS SEE PAGES 8-20

	MODEL CODE	LIST PRICE
Adjustable Height, push-pin (C, T and X Bases) Range 26"-35"	AH	\$245 per base
Adjustable Height, push-pin (C, T and X Bases) Range 29"-42"	AHB	\$320 per base
Adjustable Height, push-pin (TT Bases) Range 26"-35"	AH	\$340 per base
Adjustable Height, push-pin (TT Bases) Range 29"-42"	AHB	\$490 per base
Bar Height T, C and Y Bases	BH	\$90 per base
Bar Height TT-Base	BH	\$175 per base
Bar Height X-Base	BH	\$100 per base
Bar Height X4-Base	BH	\$315 per base
Customer specified hole in table top. Template required.	CNC	\$250 set up fee per template
Casters, locking	CS	\$20 per caster
Grommet (black or silver)	G (B/S)	\$20 per grommet
Polished Aluminum (C, T, Y and X Bases)	CR	\$90 per base
Polished Aluminum TT-Base	CR	\$165 per base
Polished Aluminum X-Base	CR	\$135 per base
Polished Aluminum X4-Base	CR	\$425 per base
Self-adjustable glides on base	SAGS	\$100 per base
Table gangers	TG	\$135 per table
Vertical ABS leg way for table base (black)	WR/B	\$50 per base
Vertical ABS leg way for table base (silver)	WR/S	\$50 per base
Vertical Laser cut holes in base (not available on X-base)	WB	\$50 per base
Horizontal 4-channel ABS extruded raceway	WH	\$80 per table

## MODESTY PANELS: 9" High straight panels

Laminate (Model Code: ML) Metal (Model Code: MM)

30" panel	\$210 list price	30" panel	\$185 list price
36" panel	\$230 list price	36" panel	\$190 list price
42" panel	\$240 list price	42" panel	\$225 list price
48" panel	\$250 list price	48" panel	\$230 list price
60" panel	\$270 list price	60" panel	\$245 list price
72" panel	\$300 list price	72" panel	\$265 list price

## Meeting Location Bases Inset

## Training Location Base Edges Mounted

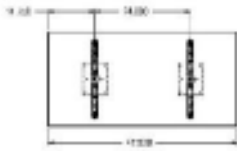

24 x 48

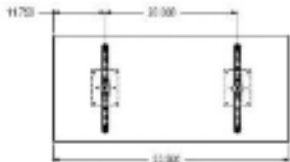
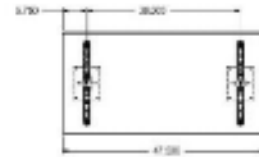

24 x 54

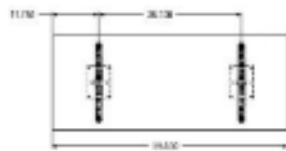
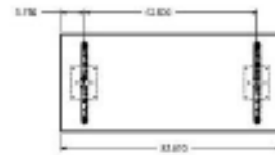

24 x 60

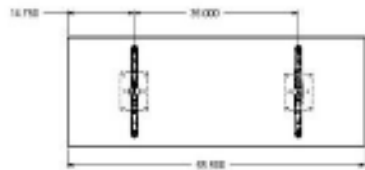
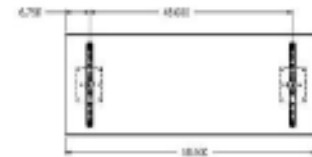

24 x 66

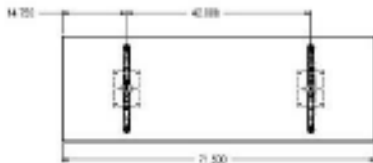
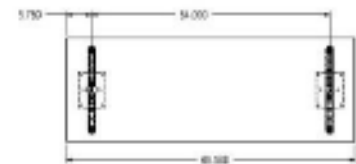

24 x 72

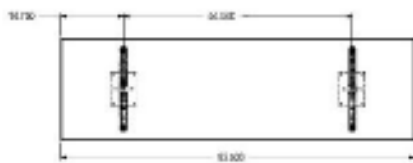
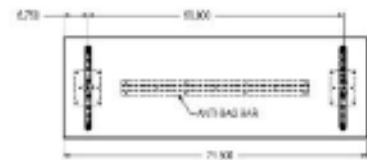

24 x 84

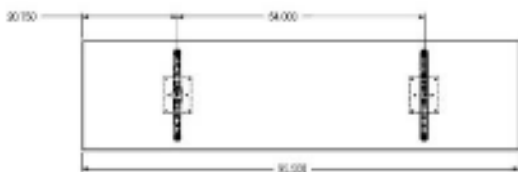
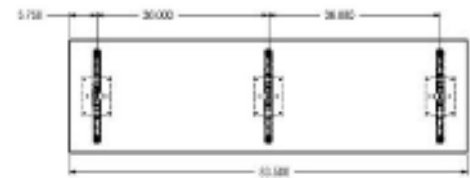

24 x 96

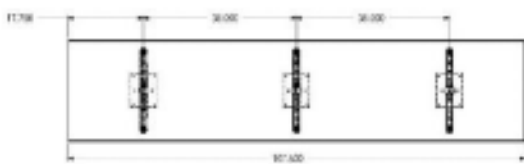
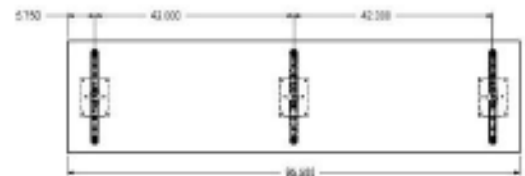

24 x 108

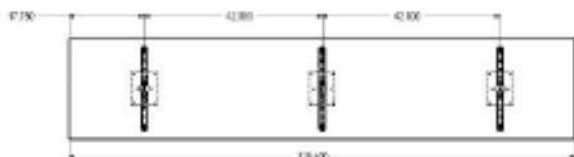
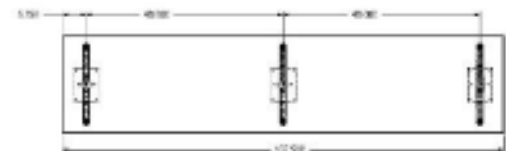

24 x 120

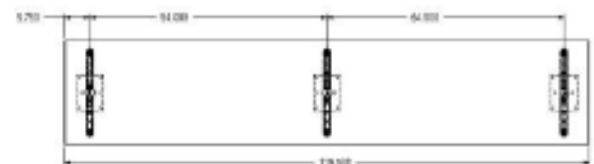

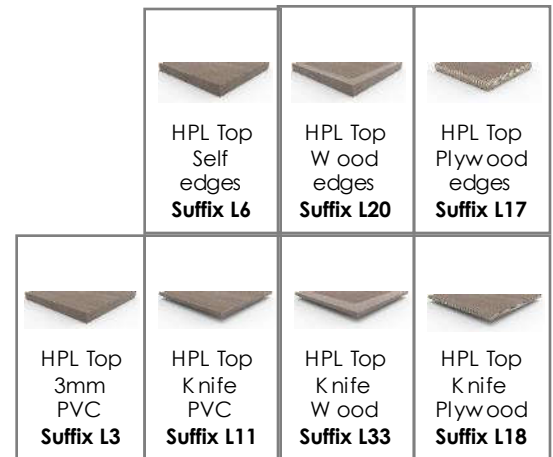

**FINISHES NEEDED:** <http://hi5furniture.com/finishes/>

HPL Top: Hi5 Graded-in laminates or Non-Premium Wilsonart or Formica  
Edge Color: Any Hi5 standard  
Base Finish: Any Hi5 standard

Table Size	Top Shape	Table Function	Model Code:	Top QTY	Base QTY	Base Spread	Base Style	HPL Top 3mm PVC Suffix L3	HPL Top Knife PVC Suffix L11	HPL Top Knife Wood Suffix L33	HPL Top Knife Plywood Suffix L18
24" x 29" H	round	stationary	SPX1 2429RDS	1	1	20"	X	\$710	\$845	\$1,275	
24" x 29" H	round	nesting	SPX1 2429RDN	1	1	20"	X	\$1,115	\$1,250	\$1,800	
24" x 36" H	round	stationary	SPX1 2436RDS	1	1	20"	X	\$810	\$945	\$1,375	
24" x 36" H	round	nesting	SPX1 2436RDN	1	1	20"	X	\$1,215	\$1,350	\$1,900	
24" x 42" H	round	stationary	SPX1 2442RDS	1	1	20"	X	\$810	\$945	\$1,375	
24" x 42" H	round	nesting	SPX1 2442RDN	1	1	20"	X	\$1,215	\$1,350	\$1,900	
30" x 29" H	round	stationary	SPX1 3029RDS	1	1	26"	X	\$775	\$970	\$1,520	
30" x 29" H	round	nesting	SPX1 3029RDN	1	1	26"	X	\$1,190	\$1,375	\$2,055	
30" x 36" H	round	stationary	SPX1 3036RDS	1	1	26"	X	\$875	\$1,070	\$1,620	
30" x 36" H	round	nesting	SPX1 3036RDN	1	1	26"	X	\$1,290	\$1,475	\$2,155	
30" x 42" H	round	stationary	SPX1 3042RDS	1	1	26"	X	\$875	\$1,070	\$1,620	
30" x 42" H	round	nesting	SPX1 3042RDN	1	1	26"	X	\$1,290	\$1,475	\$2,155	
36" x 29" H	round	stationary	SPX1 3629RDS	1	1	26"	X	\$920	\$1,065	\$1,770	
36" x 29" H	round	nesting	SPX1 3629RDN	1	1	26"	X	\$1,330	\$1,480	\$2,315	
36" x 36" H	round	stationary	SPX1 3636RDS	1	1	26"	X	\$1,020	\$1,165	\$1,870	
36" x 36" H	round	nesting	SPX1 3636RDN	1	1	26"	X	\$1,430	\$1,580	\$2,415	
36" x 42" H	round	stationary	SPX1 3642RDS	1	1	26"	X	\$1,020	\$1,165	\$1,870	
36" x 42" H	round	nesting	SPX1 3642RDN	1	1	26"	X	\$1,430	\$1,580	\$2,415	
42" x 29" H	round	stationary	SPX1 4229RDS	1	1	32"	X	\$1,135	\$1,150	\$2,140	
42" x 29" H	round	nesting	SPX1 4229RDN	1	1	32"	X	\$1,545	\$1,640	\$2,675	
42" x 36" H	round	stationary	SPX1 4236RDS	1	1	32"	X	\$1,235	\$1,250	\$2,240	
42" x 36" H	round	nesting	SPX1 4236RDN	1	1	32"	X	\$1,645	\$1,740	\$2,775	
42" x 42" H	round	stationary	SPX1 4242RDS	1	1	32"	X	\$1,235	\$1,250	\$2,240	
42" x 42" H	round	nesting	SPX1 4242RDN	1	1	32"	X	\$1,645	\$1,740	\$2,775	



**FINISHES NEEDED:** <http://hi5furniture.com/finishes/>

HPL Top: Hi5 Graded-in laminates or Non-Premium Wilsonart or Formica

Edge Color: Any Hi5 standard

Base Finish: Any Hi5 standard

	HPL Top Self edges <b>Suffix L6</b>	HPL Top Wood edges <b>Suffix L20</b>	HPL Top Plywood edges <b>Suffix L17</b>
HPL Top 3mm PVC <b>Suffix L3</b>	HPL Top Knife PVC <b>Suffix L11</b>	HPL Top Knife Wood <b>Suffix L33</b>	HPL Top Knife Plywood <b>Suffix L18</b>

**Table Size**      **Top Shape**      **Table Function**      **Model Code:**      **Top QTY** **Base QTY** **Base Spread** **Base Style**

48" x 29" H	round	stationary	SPX1 4829RDS	1	1	38"	X	\$1,190	\$1,415	\$2,495
48" x 29" H	round	nesting	SPX1 4829RDN	1	1	38"	X	\$1,595	\$1,820	\$3,025
48" x 36" H	round	stationary	SPX1 4836RDS	1	1	38"	X	\$1,290	\$1,515	\$2,595
48" x 36" H	round	nesting	SPX1 4836RDN	1	1	38"	X	\$1,695	\$1,920	\$3,125
48" x 42" H	round	stationary	SPX1 4842RDS	1	1	38"	X	\$1,290	\$1,515	\$2,595
48" x 42" H	round	nesting	SPX1 4842RDN	1	1	38"	X	\$1,695	\$1,920	\$3,125
54" x 29" H	round	stationary	SPX4 5429RDS	1	1	38"	X4	\$1,960	\$2,300	\$4,115
54" x 36" H	round	stationary	SPX4 5436RDS	1	1	38"	X4	\$2,275	\$2,615	\$4,430
54" x 42" H	round	stationary	SPX4 5442RDS	1	1	38"	X4	\$2,275	\$2,615	\$4,430
60" x 29" H	round	stationary	SPX4 6029RDS	1	1	38"	X4	\$2,030	\$2,510	\$4,570
60" x 36" H	round	stationary	SPX4 6036RDS	1	1	38"	X4	\$2,345	\$2,825	\$4,885
60" x 42" H	round	stationary	SPX4 6042RDS	1	1	38"	X4	\$2,345	\$2,825	\$4,885
72" x 29" H	round	stationary	SPX4 7229RDS	2	1	46"	X4	\$3,180	\$3,630	\$5,480
72" x 36" H	round	stationary	SPX4 7236RDS	2	1	46"	X4	\$3,495	\$3,945	\$5,795
72" x 42" H	round	stationary	SPX4 7242RDS	2	1	46"	X4	\$3,495	\$3,945	\$5,795
84" x 29" H	round	stationary	SPX4 8429RDS	2	1	58"	X4	\$3,275	\$3,720	\$8,050
84" x 36" H	round	stationary	SPX4 8436RDS	2	1	58"	X4	\$3,590	\$4,035	\$8,365
84" x 42" H	round	stationary	SPX4 8442RDS	2	1	58"	X4	\$3,590	\$4,035	\$8,365
96" x 29" H	round	stationary	SPX4 9629RDS	2	1	58"	X4	\$3,465	\$4,225	\$8,215
96" x 36" H	round	stationary	SPX4 9636RDS	2	1	58"	X4	\$3,780	\$4,540	\$8,530
96" x 42" H	round	stationary	SPX4 9642RDS	2	1	58"	X4	\$3,780	\$4,540	\$8,530

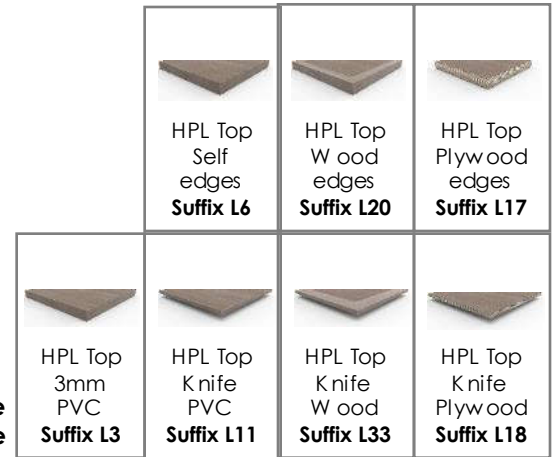

**FINISHES NEEDED:** <http://hi5furniture.com/finishes/>

HPL Top: Hi5 Graded-in laminates or Non-Premium Wilsonart or Formica  
 Edge Color: Any Hi5 standard  
 Base Finish: Any Hi5 standard

Table Size	Top Shape	Table Function	Model Code:	Top QTY	Base QTY	Base Spread	Base Style	HPL Top 3mm PVC Suffix L3	HPL Top Knife PVC Suffix L11	HPL Top Knife Wood Suffix L33	HPL Top Knife Plywood Suffix L18
24" x 24" x 29" H	square	stationary	SPX1 24S2429QS	1	1	20"	X	\$625	\$750	\$1,045	
24" x 24" x 29" H	square	nesting	SPX1 242429SQN	1	1	20"	X	\$1,030	\$1,160	\$1,530	
24" x 24" x 36" H	square	stationary	SPX1 24S2436QS	1	1	20"	X	\$725	\$850	\$1,145	
24" x 24" x 36" H	square	nesting	SPX1 236436SQN	1	1	20"	X	\$1,130	\$1,260	\$1,630	
24" x 24" x 42" H	square	stationary	SPX1 24S2442QS	1	1	20"	X	\$725	\$850	\$1,145	
24" x 24" x 42" H	square	nesting	SPX1 242442SQN	1	1	20"	X	\$1,130	\$1,260	\$1,630	
30" x 30" x 29" H	square	stationary	SPX1 303029QS	1	1	26"	X	\$705	\$865	\$1,270	
30" x 30" x 29" H	square	nesting	SPX1 303029SQN	1	1	26"	X	\$1,115	\$1,275	\$1,755	
30" x 30" x 36" H	square	stationary	SPX1 303036QS	1	1	26"	X	\$805	\$965	\$1,370	
30" x 30" x 36" H	square	nesting	SPX1 303036SQN	1	1	26"	X	\$1,215	\$1,375	\$1,855	
30" x 30" x 42" H	square	stationary	SPX1 303042QS	1	1	26"	X	\$805	\$965	\$1,370	
30" x 30" x 42" H	square	nesting	SPX1 303042SQN	1	1	26"	X	\$1,215	\$1,375	\$1,855	
36" x 36" x 29" H	square	stationary	SPX1 363629QS	1	1	26"	X	\$865	\$1,005	\$1,535	
36" x 36" x 29" H	square	nesting	SPX1 363629SQN	1	1	26"	X	\$1,275	\$1,420	\$2,025	
36" x 36" x 36" H	square	stationary	SPX1 363636QS	1	1	26"	X	\$965	\$1,105	\$1,635	
36" x 36" x 36" H	square	nesting	SPX1 363636SQN	1	1	26"	X	\$1,375	\$1,520	\$2,125	
36" x 36" x 42" H	square	stationary	SPX1 363642QS	1	1	26"	X	\$965	\$1,105	\$1,635	
36" x 36" x 42" H	square	nesting	SPX1 363642SQN	1	1	26"	X	\$1,375	\$1,520	\$2,125	
42" x 42" x 29" H	square	stationary	SPX1 424229QS	1	1	33"	X	\$880	\$1,275	\$1,960	
42" x 42" x 29" H	square	nesting	SPX1 424229SQN	1	1	33"	X	\$1,370	\$1,680	\$2,435	
42" x 42" x 36" H	square	stationary	SPX1 363636QS	1	1	33"	X	\$980	\$1,375	\$2,060	
42" x 42" x 36" H	square	nesting	SPX1 363636SQN	1	1	33"	X	\$1,470	\$1,780	\$2,535	
42" x 42" x 42" H	square	stationary	SPX1 424242QS	1	1	33"	X	\$980	\$1,375	\$2,060	
42" x 42" x 42" H	square	nesting	SPX1 424242SQN	1	1	33"	X	\$1,470	\$1,780	\$2,535	



**FINISHES NEEDED:** <http://hi5furniture.com/finishes/>  
 HPL Top: Hi5 Graded-in laminates or Non-Premium Wilsonart or Formica  
 Edge Color: Any Hi5 standard  
 Base Finish: Any Hi5 standard

Table Size	Top Shape	Table Function	Model Code:	Top QTY	Base QTY	Base Spread	Base Style		HPL Top 3mm PVC Suffix L3	HPL Top Knife PVC Suffix L11	HPL Top Knife Wood Suffix L33	HPL Top Knife Plywood Suffix L18
48" x 48" x 29" H	square	stationary	SPX1 484829SQS	1	1	38"	X		\$1,035	\$1,320		\$2,155
48" x 48" x 29" H	square	nesting	SPX1 484829SQN	1	1	38"	X		\$1,435	\$1,735		\$2,635
48" x 48" x 36" H	square	stationary	SPX1 484836SQS	1	1	38"	X		\$1,135	\$1,420		\$2,255
48" x 48" x 36" H	square	nesting	SPX1 484836SQN	1	1	38"	X		\$1,535	\$1,835		\$2,735
48" x 48" x 42" H	square	stationary	SPX1 484842SQS	1	1	38"	X		\$1,135	\$1,420		\$2,255
48" x 48" x 42" H	square	nesting	SPX1 484842SQN	1	1	38"	X		\$1,535	\$1,835		\$2,735
54" x 54" x 29" H	square	stationary	SPX4 54S5429QS	1	1	38"	X4		\$1,830	\$2,310		\$3,640
54" x 54" x 36" H	square	stationary	SPX4 54S5436QS	1	1	38"	X4		\$2,145	\$2,625		\$3,955
54" x 54" x 42" H	square	stationary	SPX4 54S5442QS	1	1	38"	X4		\$2,145	\$2,625		\$3,955
60" x 60" x 29" H	square	stationary	SPX4 606029SQS	1	1	38"	X4		\$1,880	\$2,395		\$3,830
60" x 60" x 36" H	square	stationary	SPX4 606036SQS	1	1	38"	X4		\$2,195	\$2,710		\$4,145
60" x 60" x 42" H	square	stationary	SPX4 606042SQS	1	1	38"	X4		\$2,195	\$2,710		\$4,145

**POWER & A/V OPTIONS SEE PAGES 8-20**  
**SUPREME TABLE OPTIONS, SEE PAGE 163**

Bar Height X-Base	BH	\$100 per base
Bar Height X4-Base	BH	\$315 per base
Casters, locking	CS	\$20 per caster
Polished Aluminum X-Base	CR	\$135 per base
Polished Aluminum X4-Base	CR	\$425 per base
Vertical Laser cut holes in base	WB	\$50 per base
Horizontal 4-channel ABS extruded raceway	WH	\$80 per table



TRAPEZOID



HALF ROUND



CRESCENT

NOTE: Nesting tables come standard on locking casters.

**FINISHES NEEDED:** <http://hi5furniture.com/finishes/>

HPL Top: Hi5 Graded-in laminates or Non-Premium Wilsonart or Formica

Edge Color: Any Hi5 standard

Base Finish: Any Hi5 standard

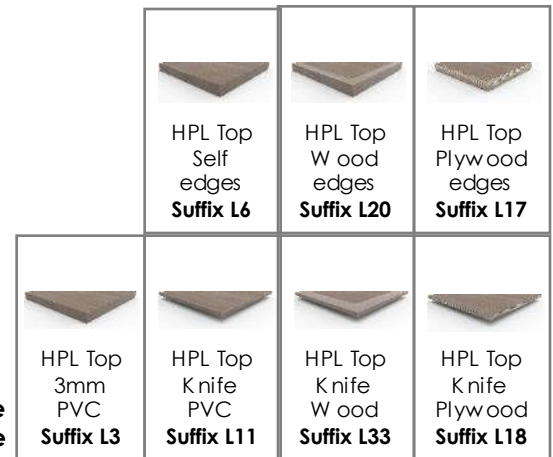

Table Size	Top Shape	Table Function	Model Code:	Base QTY	Base Spread	Base Style	
24 x 48x 29" H	half round	stationary	SPT1 244829HR S	2	15"	T	\$785
24 x 48x 29" H	half round	nesting	SPT1 244829HR N	2	15"	T	\$1,285
30 x 60x 29" H	half round	stationary	SPT1 306029HR S	2	20"	T	\$920
30 x 60x 29" H	half round	nesting	SPT1 306029HR N	2	20"	T	\$1,420
36 x 72x 29" H	half round	stationary	SPT1 367229HR S	2	26"	T	\$1,135
36 x 72x 29" H	half round	nesting	SPT1 367229HR N	2	26"	T	\$1,625
24 x 60x 29" H	trapezoid	stationary	SPT1 246029TZ S	2	15"	T	\$750
24 x 60x 29" H	trapezoid	nesting	SPT1 246029TZ N	2	15"	T	\$1,205
24 x 72x 29" H	trapezoid	stationary	SPT1 247229TZ S	2	15"	T	\$885
24 x 72x 29" H	trapezoid	nesting	SPT1 247229TZ N	2	15"	T	\$1,340
30 x 60x 29" H	trapezoid	stationary	SPT1 306029TZ S	2	20"	T	\$845
30 x 60x 29" H	trapezoid	nesting	SPT1 306029TZ N	2	20"	T	\$1,305
30 x 72x 29" H	trapezoid	stationary	SPT1 307229TZ S	2	20"	T	\$1,005
30 x 72x 29" H	trapezoid	nesting	SPT1 307229TZ N	2	20"	T	\$1,465
24 x 48x 29" H	crescent	stationary	SPT1 244829CR S	2	20"	T	\$1,200
24 x 48x 29" H	crescent	nesting	SPT1 244829CR N	2	20"	T	\$1,700
30 x 60x 29" H	crescent	stationary	SPT1 306029CR S	2	26"	T	\$1,585
30 x 60x 29" H	crescent	nesting	SPT1 306029CR N	2	26"	T	\$2,075
36 x 72x 29" H	crescent	stationary	SPT1 367229CR S	2	26"	T	\$1,975

**POWER & A/V OPTIONS SEE PAGES 8-20**  
**SUPREME TABLE OPTIONS, SEE PAGE 163**

Bar Height T, C and Y Bases	BH	\$90 per base
Casters, locking	CS	\$20 per caster
Polished Aluminum (C, T, Y and X Bases)	CR	\$90 per base
Vertical Laser cut holes in base (not available on X-base)	WB	\$50 per base
Horizontal 4-channel ABS extruded raceway	WH	\$80 per table





**FINISHES NEEDED:** <http://hi5furniture.com/finishes/>

HPL Top: Hi5 Graded-in laminates or Non-Premium Wilsonart or Formica  
 Edge Color: Any Hi5 standard  
 Base Finish: Any Hi5 standard

Table Size	Top Shape	Table Function	Model Code:	Top QTY	Base QTY	Base Spread	Base Style	HPL Top 3mm PVC Suffix L3	HPL Top Knife PVC Suffix L11	HPL Top Knife Wood Suffix L33	HPL Top Knife Plywood Suffix L18
18 x 48x 29" H	rectangle	stationary	SPT1 184829RES	1	2	15	T	\$830	\$950		\$1,540
18 x 48x 29" H	rectangle	nesting	SPT1 184829REN	1	2	15	T	\$1,370	\$1,500		\$2,195
18 x 48x 29" H	rectangle	stationary	SPY0 184829RES	1	2	18	Y	\$1,030	\$1,100		\$1,625
18 x 60x 29" H	rectangle	stationary	SPT1 186029RES	1	2	15	T	\$890	\$1,010		\$1,490
18 x 60x 29" H	rectangle	folding	SPT1 186029REF	1	2	15	T	\$1,260	\$1,390		\$1,935
18 x 60x 29" H	rectangle	nesting	SPT1 186029REN	1	2	15	T	\$1,440	\$1,575		\$2,145
18 x 60x 29" H	rectangle	stationary	SPY0 186029RES	1	2	18	Y	\$1,110	\$1,190		\$1,860
18 x 72x 29" H	rectangle	stationary	SPT1 187229RES	1	2	15	T	\$935	\$1,090		\$1,625
18 x 72x 29" H	rectangle	folding	SPT1 187229REF	1	2	15	T	\$1,310	\$1,460		\$2,070
18 x 72x 29" H	rectangle	nesting	SPT1 187229REN	1	2	15	T	\$1,485	\$1,640		\$2,275
18 x 72x 29" H	rectangle	stationary	SPY0 187229RES	1	2	18	Y	\$1,185	\$1,280		\$2,120
18 x 84x 29" H	rectangle	stationary	SPT1 188429RES	1	2	15	T	\$1,135	\$1,255		\$1,925
18 x 84x 29" H	rectangle	folding	SPT1 188429REF	1	2	15	T	\$1,535	\$1,660		\$2,400
18 x 84x 29" H	rectangle	stationary	SPY0 188429RES	1	2	18	Y	\$1,335	\$1,440		\$2,855
18 x 96x 29" H	rectangle	stationary	SPT1 189629RES	1	2	15	T	\$1,145	\$1,325		\$2,245
18 x 96x 29" H	rectangle	folding	SPT1 189629REF	1	2	15	T	\$1,550	\$1,735		\$2,725
18 x 96x 29" H	rectangle	stationary	SPY0 189629RES	1	2	18	Y	\$1,340	\$1,470		\$2,825

**POWER & A/V OPTIONS SEE PAGES 8-20**  
**SUPREME TABLE OPTIONS, SEE PAGE 163**

Bar Height T, C and Y Bases	BH	\$90 per base
Casters, locking	CS	\$20 per caster
Polished Aluminum (C, T, Y and X Bases)	CR	\$90 per base
Vertical Laser cut holes in base (not available on X-base)	WB	\$50 per base
Horizontal 4-channel ABS extruded raceway	WH	\$80 per table



**FINISHES NEEDED:** <http://hi5furniture.com/finishes/>

HPL Top: Hi5 Graded-in laminates or Non-Premium Wilsonart or Formica

Edge Color: Any Hi5 standard

Base Finish: Any Hi5 standard

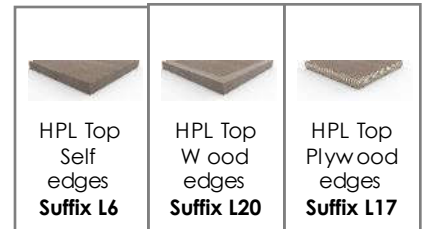

Table Size	Top Shape	Table Function	Model Code:	Top QTY	Base QTY	Base Spread	Base Style			
24 x 48x 29" H	rectangle	stationary	SPT1 244829RES	1	2	20	T	\$865	\$1,045	\$1,540
24 x 48x 29" H	rectangle	stationary	SPY0 244829RES	1	2	18"	Y	\$1,050	\$1,120	\$1,625
24 x 48x 29" H	rectangle	nesting	SPT1 244829REN	1	2	20	T	\$1,415	\$1,595	\$2,195
24 x 60x 29" H	rectangle	stationary	SPT1 246029RES	1	2	20"	T	\$915	\$1,120	\$1,715
24 x 60x 29" H	rectangle	stationary	SPY0 246029RES	1	2	18"	Y	\$1,135	\$1,215	\$1,860
24 x 60x 29" H	rectangle	folding	SPT1 246029REF	1	2	20	T	\$1,280	\$1,495	\$2,155
24 x 60x 29" H	rectangle	nesting	SPT1 246029REN	1	2	20	T	\$1,465	\$1,670	\$2,370
24 x 72x 29" H	rectangle	stationary	SPT1 247229RES	1	2	20	T	\$955	\$1,210	\$1,880
24 x 72x 29" H	rectangle	stationary	SPY0 247229RES	1	2	18"	Y	\$1,210	\$1,305	\$2,120
24 x 72x 29" H	rectangle	folding	SPT1 247229REF	1	2	20	T	\$1,330	\$1,585	\$2,320
24 x 72x 29" H	rectangle	nesting	SPT1 247229REN	1	2	20	T	\$1,515	\$1,765	\$2,530
24 x 84x 29" H	rectangle	stationary	SPT1 248429RES	1	2	20	T	\$1,155	\$1,405	\$2,245
24 x 84x 29" H	rectangle	stationary	SPY0 248429RES	1	2	18"	Y	\$1,365	\$1,470	\$2,815
24 x 84x 29" H	rectangle	folding	SPT1 248429REF	1	2	20	T	\$1,555	\$1,815	\$2,725
24 x 96x 29" H	rectangle	stationary	SPT1 249629RES	1	2	20	T	\$1,165	\$1,500	\$2,425
24 x 96x 29" H	rectangle	stationary	SPY0 249629RES	1	2	18"	Y	\$1,370	\$1,495	\$2,825
24 x 96x 29" H	rectangle	folding	SPT1 249629REF	1	2	20	T	\$1,575	\$1,920	\$2,910

**POWER & A/V OPTIONS SEE PAGES 8-20**

**SUPREME TABLE OPTIONS, SEE PAGE 163**

Bar Height T, C and Y Bases	BH	\$90 per base
Casters, locking	CS	\$20 per caster
Polished Aluminum (C, T, Y and X Bases)	CR	\$90 per base
Vertical Laser cut holes in base (not available on X-base)	WB	\$50 per base
Horizontal 4-channel ABS extruded raceway	WH	\$80 per table



**FINISHES NEEDED:** <http://hi5furniture.com/finishes/>  
 HPL Top: Hi5 Graded-in laminates or Non-Premium Wilsonart or Formica  
 Edge Color: Any Hi5 standard  
 Base Finish: Any Hi5 standard



Table Size	Top Shape	Table Function	Model Code:	Top QTY	Base QTY	Base Spread	Base Style			
30 x 48x 29" H	rectangle	stationary	SPT1 304829RES	1	2	26	T	\$940	\$1,155	\$1,745
30 x 48x 29" H	rectangle	stationary	SPY0 304829RES	1	2	23	Y	\$1,185	\$1,260	\$1,920
30 x 48x 29" H	rectangle	nesting	SPT1 304829REN	1	2	26	T	\$1,480	\$1,695	\$2,380
30 x 60x 29" H	rectangle	stationary	SPT1 306029RES	1	2	26	T	\$995	\$1,255	\$1,960
30 x 60x 29" H	rectangle	stationary	SPY0 306029RES	1	2	23	Y	\$1,280	\$1,370	\$2,220
30 x 60x 29" H	any shape	stationary	SPT1 306029??S	1	2	26	T	\$1,260	\$1,355	\$2,070
30 x 60x 29" H	any shape	stationary	SPY1 306029??S	1	2	23	Y	\$1,280	\$1,370	\$2,525
30 x 60x 29" H	rectangle	folding	SPT1 306029REF	1	2	26	T	\$1,355	\$1,610	\$2,380
30 x 60x 29" H	rectangle	nesting	SPT1 306029REN	1	2	26	T	\$1,535	\$1,795	\$2,590
30 x 72x 29" H	rectangle	stationary	SPT1 307229RES	1	2	26	T	\$1,050	\$1,360	\$2,165
30 x 72x 29" H	rectangle	stationary	SPY0 307229RES	1	2	23	Y	\$1,375	\$1,480	\$2,540
30 x 72x 29" H	any shape	stationary	SPT1 307229??S	1	2	26	T	\$1,315	\$1,460	\$2,275
30 x 72x 29" H	any shape	stationary	SPY1 307229??S	1	2	23	Y	\$1,375	\$1,480	\$2,845
30 x 72x 29" H	rectangle	folding	SPT1 307229REF	1	2	26	T	\$1,410	\$1,720	\$2,590
30 x 72x 29" H	rectangle	nesting	SPT1 307229REN	1	2	26	T	\$1,590	\$1,905	\$2,810
30 x 84x 29" H	rectangle	stationary	SPT1 308429RES	1	2	26	T	\$1,275	\$1,595	\$2,590
30 x 84x 29" H	rectangle	stationary	SPY0 308429RES	1	2	23	Y	\$1,535	\$1,655	\$3,405
30 x 84x 29" H	any shape	stationary	SPT1 308429??S	1	2	26	T	\$1,570	\$1,700	\$2,725
30 x 84x 29" H	any shape	stationary	SPY1 308429??S	1	2	23	Y	\$1,535	\$1,655	\$3,735
30 x 84x 29" H	rectangle	folding	SPT1 308429REF	1	2	26	T	\$1,665	\$1,990	\$3,055
30 x 96x 29" H	rectangle	stationary	SPT1 309629RES	1	2	26	T	\$1,295	\$1,705	\$2,820
30 x 96x 29" H	rectangle	stationary	SPY0 309629RES	1	2	23	Y	\$1,550	\$1,685	\$3,430
30 x 96x 29" H	any shape	stationary	SPT1 309629??S	1	2	26	T	\$1,585	\$1,805	\$2,955
30 x 96x 29" H	any shape	stationary	SPY1 309629??S	1	2	23	Y	\$1,550	\$1,685	\$3,800
30 x 96x 29" H	rectangle	folding	SPT1 309629REF	1	2	26	T	\$1,685	\$2,095	\$3,285

**POWER & A/V OPTIONS SEE PAGES 8-20**  
**SUPREME TABLE OPTIONS, SEE PAGE 163**

Bar Height T, C and Y Bases	BH	\$90 per base
Casters, locking	CS	\$20 per caster
Polished Aluminum (C, T, Y and X Bases)	CR	\$90 per base
Vertical Laser cut holes in base (not available on X-base)	WB	\$50 per base
Horizontal 4-channel ABS extruded raceway	WH	\$80 per table

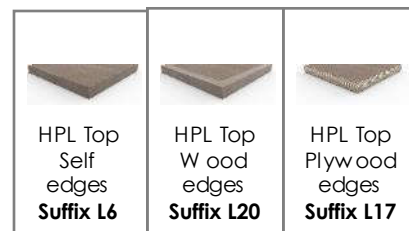

**FINISHES NEEDED:** <http://hi5furniture.com/finishes/>

HPL Top: Hi5 Graded-in laminates or Non-Premium Wilsonart or Formica  
Edge Color: Any Hi5 standard  
Base Finish: Any Hi5 standard

Table Size	Top Shape	Table Function	Model Code:	Top QTY	Base QTY	Base Spread	Base Style	HPL Top 3mm PVC Suffix L3	HPL Top Knife PVC Suffix L11	HPL Top Knife Wood Suffix L33	HPL Top Knife Plywood Suffix L18
36 x 48x 29" H	rectangle	stationary	SPT1 364829RES	1	2	26	T	\$1,205	\$1,370		\$2,070
36 x 48x 29" H	rectangle	stationary	SPY1 364829RES	1	2	33	Y	\$1,900	\$1,980		\$2,790
36 x 60x 29" H	rectangle	stationary	SPT1 366029RES	1	2	26	T	\$1,280	\$1,490		\$2,315
36 x 60x 29" H	rectangle	stationary	SPY1 366029RES	1	2	33	Y	\$2,025	\$2,125		\$3,155
36 x 60x 29" H	any shape	stationary	SPT1 366029??S	1	2	26	T	\$1,545	\$1,585		\$2,430
36 x 60x 29" H	any shape	stationary	SPY1 366029??S	1	2	33	Y	\$2,025	\$2,125		\$3,460
36 x 72x 29" H	rectangle	stationary	SPT1 367229RES	1	2	26	T	\$1,365	\$1,605		\$2,565
36 x 72x 29" H	rectangle	stationary	SPY1 367229RES	1	2	33	Y	\$2,140	\$2,255		\$3,535
36 x 72x 29" H	any shape	stationary	SPT1 367229??S	1	2	26	T	\$1,635	\$1,705		\$2,675
36 x 72x 29" H	any shape	stationary	SPY1 367229??S	1	2	33	Y	\$2,140	\$2,255		\$3,840
36 x 84x 29" H	rectangle	stationary	SPT2 368429RES	1	2	34	TT	\$1,935	\$2,125		\$3,355
36 x 84x 29" H	rectangle	stationary	SPY1 368429RES	1	2	33	Y	\$2,590	\$2,755		\$4,605
36 x 84x 29" H	any shape	stationary	SPT2 368429??S	1	2	34	TT	\$2,230	\$2,235		\$3,510
36 x 84x 29" H	any shape	stationary	SPY1 368429??S	1	2	33	Y	\$2,590	\$2,755		\$4,935
36 x 96x 29" H	rectangle	stationary	SPT2 369629RES	1	2	34	TT	\$1,955	\$2,255		\$3,630
36 x 96x 29" H	rectangle	stationary	SPY1 369629RES	1	2	33	Y	\$2,730	\$2,905		\$4,765
36 x 96x 29" H	any shape	stationary	SPT2 369629??S	1	2	34	TT	\$2,245	\$2,395		\$3,750
36 x 96x 29" H	any shape	stationary	SPY1 369629??S	1	2	33	Y	\$2,730	\$2,905		\$5,070
36 x 120x 29" H	rectangle	stationary	SPT2 3612029RES	1	3	34	TT	\$2,645	\$3,040		\$4,790

**POWER & A/V OPTIONS SEE PAGES 8-20**  
**SUPREME TABLE OPTIONS, SEE PAGE 163**

Bar Height T, C and Y Bases	BH	\$90 per base
Bar Height TT-Base	BH	\$175 per base
Casters, locking	CS	\$20 per caster
Polished Aluminum (C, T, Y and X Bases)	CR	\$90 per base
Polished Aluminum TT-Base	CR	\$165 per base
Vertical Laser cut holes in base (not available on X-base)	WB	\$50 per base
Horizontal 4-channel ABS extruded raceway	WH	\$80 per table



**FINISHES NEEDED:** <http://hi5furniture.com/finishes/>

HPL Top: Hi5 Graded-in laminates or Non-Premium Wilsonart or Formica

Edge Color: Any Hi5 standard

Base Finish: Any Hi5 standard

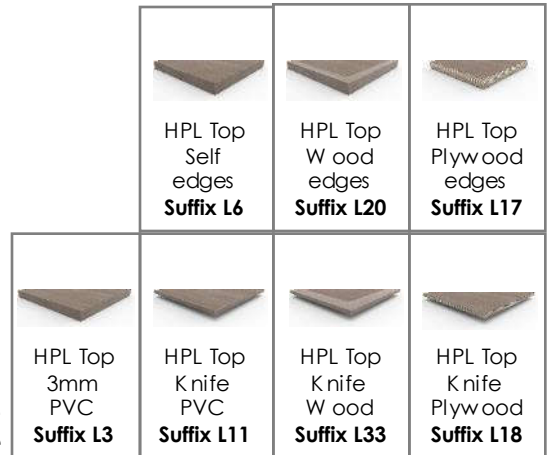

Table Size	Top Shape	Table Function	Model Code:	Top QTY	Base QTY	Base Spread	Base Style			
42 x 60x 29" H	rectangle	stationary	SPT2 426029RES	1	2	34	TT	\$1,525	\$1,905	\$2,980
42 x 60x 29" H	rectangle	stationary	SPY1 426029RES	1	2	33	Y	\$2,015	\$2,120	\$3,770
42 x 60x 29" H	any shape	stationary	SPT2 426029??S	1	2	34	TT	\$1,790	\$2,000	\$3,090
42 x 60x 29" H	any shape	stationary	SPY1 426029??S	1	2	33	Y	\$2,130	\$2,250	\$4,075
42 x 72x 29" H	rectangle	stationary	SPT2 427229RES	1	2	34	TT	\$1,600	\$2,055	\$3,300
42 x 72x 29" H	rectangle	stationary	SPY1 427229RES	1	2	33	Y	\$2,135	\$2,255	\$4,270
42 x 72x 29" H	any shape	stationary	SPT2 427229??S	1	2	34	TT	\$1,865	\$2,155	\$3,420
42 x 72x 29" H	any shape	stationary	SPY1 427229??S	1	2	33	Y	\$2,245	\$2,375	\$4,570
42 x 84x 29" H	rectangle	stationary	SPT2 428429RES	1	2	34	TT	\$1,955	\$3,350	\$5,070
42 x 84x 29" H	rectangle	stationary	SPY1 428429RES	1	2	33	Y	\$2,620	\$2,790	\$5,730
42 x 84x 29" H	any shape	stationary	SPT2 428429??S	1	2	34	TT	\$2,245	\$3,465	\$5,185
42 x 84x 29" H	any shape	stationary	SPY1 428429??S	1	2	33	Y	\$2,730	\$2,915	\$6,000
42 x 96x 29" H	rectangle	stationary	SPT2 429629RES	1	2	34	TT	\$2,070	\$3,515	\$5,425
42 x 96x 29" H	rectangle	stationary	SPY1 429629RES	1	2	33	Y	\$2,675	\$2,850	\$5,780
42 x 96x 29" H	any shape	stationary	SPT2 429629??S	1	2	34	TT	\$2,255	\$3,630	\$5,200
42 x 96x 29" H	any shape	stationary	SPY1 429629??S	1	2	33	Y	\$2,770	\$2,960	\$6,440
42 x 120x 29" H	rectangle	stationary	SPT2 4212029RES	1	3	34	TT	\$2,680	\$4,380	\$6,755
42 x 120x 29" H	rectangle	stationary	SPY1 4212029RES	1	3	33	Y	\$2,985	\$3,200	\$6,910
42 x 120x 29" H	any shape	stationary	SPT2 4212029??S	1	3	34	TT	\$2,970	\$4,490	\$6,875
42 x 120x 29" H	any shape	stationary	SPY1 4212029??S	1	3	33	Y	\$3,090	\$3,315	\$7,580
42 x 144x 29" H	rectangle	stationary	SPT2 4214429RES	2	4	34	TT	\$3,800	\$5,380	\$8,235
42 x 144x 29" H	any shape	stationary	SPT2 4214429??S	2	4	34	TT	\$4,090	\$5,490	\$8,365
42 x 168x 29" H	rectangle	stationary	SPT2 4216829RES	2	4	34	TT	\$3,830	\$5,930	\$9,475
42 x 168x 29" H	any shape	stationary	SPT2 4216829??S	2	4	34	TT	\$4,115	\$6,025	\$9,570
42 x 192x 29" H	rectangle	stationary	SPT2 4219229RES	2	4	34	TT	\$3,850	\$6,050	\$9,655
42 x 192x 29" H	any shape	stationary	SPT2 4219229??S	2	4	34	TT	\$4,140	\$6,155	\$9,775

**POWER & A/V OPTIONS SEE PAGES 8-20**

**SUPREME TABLE OPTIONS, SEE PAGE 163**

Bar Height T, C and Y Bases	BH	\$90 per base
Bar Height TT-Base	BH	\$175 per base
Polished Aluminum (C, T, Y and X Bases)	CR	\$90 per base
Polished Aluminum TT-Base	CR	\$165 per base



**FINISHES NEEDED:** <http://hi5furniture.com/finishes/>  
 HPL Top: Hi5 Graded-in laminates or Non-Premium Wilsonart or Formica  
 Edge Color: Any Hi5 standard  
 Base Finish: Any Hi5 standard

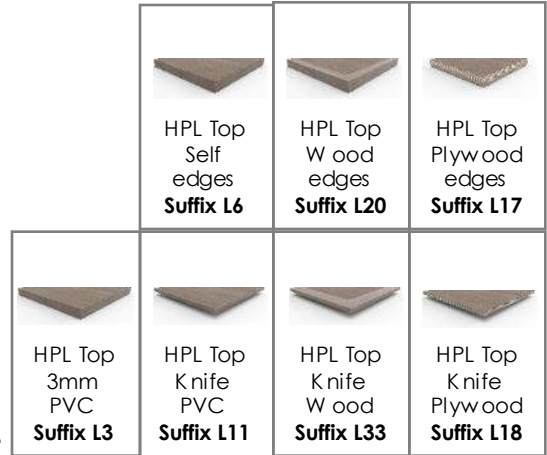

Table Size	Top Shape	Table Function	Model Code:	Top QTY	Base QTY	Base Spread	Base Style		HPL Top 3mm PVC Suffix L3	HPL Top Knife PVC Suffix L11	HPL Top Knife Wood Suffix L33	HPL Top Knife Plywood Suffix L18
48 x 60x 29" H	rectangle	stationary	SPT2 486029RES	1	2	34	TT		\$1,525	\$1,905		\$2,980
48 x 60x 29" H	rectangle	stationary	SPY1 486029RES	1	2	33	Y		\$2,015	\$2,120		\$3,770
48 x 60x 29" H	any shape	stationary	SPT2 486029??S	1	2	34	TT		\$1,790	\$2,000		\$3,090
48 x 60x 29" H	any shape	stationary	SPY1 486029??S	1	2	33	Y		\$2,130	\$2,250		\$4,075
48 x 72x 29" H	rectangle	stationary	SPT2 487229RES	1	2	34	TT		\$1,600	\$2,055		\$3,300
48 x 72x 29" H	rectangle	stationary	SPY1 487229RES	1	2	33	Y		\$2,135	\$2,255		\$4,270
48 x 72x 29" H	any shape	stationary	SPT2 487229??S	1	2	34	TT		\$1,865	\$2,155		\$3,420
48 x 72x 29" H	any shape	stationary	SPY1 487229??S	1	2	33	Y		\$2,245	\$2,375		\$4,570
48 x 84x 29" H	rectangle	stationary	SPT2 488429RES	1	2	34	TT		\$1,955	\$3,350		\$5,070
48 x 84x 29" H	rectangle	stationary	SPY1 488429RES	1	2	33	Y		\$2,620	\$2,790		\$5,730
48 x 84x 29" H	any shape	stationary	SPT2 488429??S	1	2	34	TT		\$2,245	\$3,465		\$5,185
48 x 84x 29" H	any shape	stationary	SPY1 488429??S	1	2	33	Y		\$2,730	\$2,915		\$6,000
48 x 96x 29" H	rectangle	stationary	SPT2 489629RES	1	2	34	TT		\$2,070	\$3,515		\$5,425
48 x 96x 29" H	rectangle	stationary	SPY1 489629RES	1	2	33	Y		\$2,675	\$2,850		\$5,780
48 x 96x 29" H	any shape	stationary	SPT2 489629??S	1	2	34	TT		\$2,255	\$3,630		\$5,200
48 x 96x 29" H	any shape	stationary	SPY1 489629??S	1	2	33	Y		\$2,770	\$2,960		\$6,440
48 x 120x 29" H	rectangle	stationary	SPT2 4812029RES	1	3	34	TT		\$2,680	\$4,380		\$6,755
48 x 120x 29" H	rectangle	stationary	SPY1 4812029RES	1	3	33	Y		\$2,985	\$3,200		\$6,910
48 x 120x 29" H	any shape	stationary	SPT2 4812029??S	1	3	34	TT		\$2,970	\$4,490		\$6,875
48 x 120x 29" H	any shape	stationary	SPY1 4812029??S	1	3	33	Y		\$3,090	\$3,315		\$7,580
48 x 144x 29" H	rectangle	stationary	SPT2 4814429RES	2	4	34	TT		\$3,800	\$5,380		\$8,235
48 x 144x 29" H	any shape	stationary	SPT2 4814429??S	2	4	34	TT		\$4,090	\$5,490		\$8,365
48 x 168x 29" H	rectangle	stationary	SPT2 4816829RES	2	4	34	TT		\$3,830	\$5,930		\$9,475
48 x 168x 29" H	any shape	stationary	SPT2 4816829??S	2	4	34	TT		\$4,115	\$6,025		\$9,570
48 x 192x 29" H	rectangle	stationary	SPT2 4819229RES	2	4	34	TT		\$3,850	\$6,050		\$9,655
48 x 192x 29" H	any shape	stationary	SPT2 4819229??S	2	4	34	TT		\$4,140	\$6,155		\$9,775

**POWER & A/V OPTIONS SEE PAGES 8-20**

**SUPREME TABLE OPTIONS, SEE PAGE 163**

Bar Height T, C and Y Bases	BH	\$90 per base
Bar Height TT-Base	BH	\$175 per base
Polished Aluminum (C, T, Y and X Bases)	CR	\$90 per base
Polished Aluminum TT-Base	CR	\$165 per base



**FINISHES NEEDED:** <http://hi5furniture.com/finishes/>

HPL Top: Hi5 Graded-in laminates or Non-Premium Wilsonart or Formica

Edge Color: Any Hi5 standard

Base Finish: Any Hi5 standard

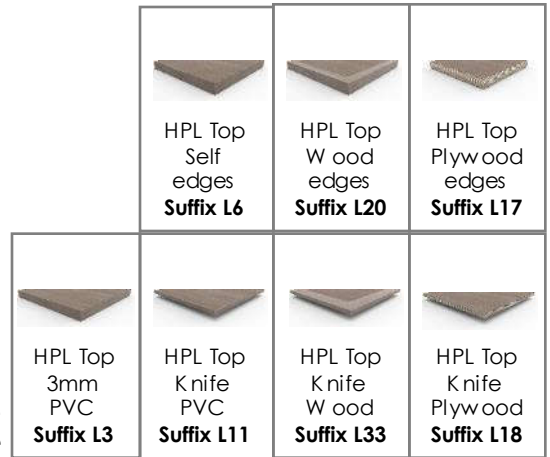

Table Size	Top Shape	Table Function	Model Code:	Top QTY	Base QTY	Base Spread	Base Style	HPL Top 3mm PVC Suffix L3	HPL Top Knife PVC Suffix L11	HPL Top Knife Wood Suffix L33	HPL Top Knife Plywood Suffix L18
60 x 72x 29" H	rectangle	stationary	SPT2 607229RES	1	2	40	TT	\$1,920	\$3,630		\$5,480
60 x 72x 29" H	any shape	stationary	SPT2 607229??S	1	2	40	TT	\$2,215	\$3,735		\$5,595
60 x 84x 29" H	rectangle	stationary	SPT2 608429RES	1	2	40	TT	\$2,165	\$3,695		\$5,740
60 x 84x 29" H	any shape	stationary	SPT2 608429??S	1	2	40	TT	\$2,460	\$3,805		\$5,875
60 x 96x 29" H	rectangle	stationary	SPT2 609629RES	1	2	40	TT	\$2,185	\$3,905		\$6,175
60 x 96x 29" H	any shape	stationary	SPT2 609629??S	1	2	40	TT	\$2,475	\$4,005		\$6,305
60 x 120x 29" H	rectangle	stationary	SPT2 6012029RES	1	3	40	TT	\$2,935	\$4,870		\$7,705
60 x 120x 29" H	any shape	stationary	SPT2 6012029??S	1	3	40	TT	\$3,225	\$4,965		\$7,825
60 x 144x 29" H	rectangle	stationary	SPT2 6014429RES	2	4	40	TT	\$4,210	\$5,975		\$9,390
60 x 144x 29" H	any shape	stationary	SPT2 6014429??S	2	4	40	TT	\$4,500	\$6,080		\$9,515
60 x 168x 29" H	rectangle	stationary	SPT2 6016829RES	2	4	40	TT	\$4,240	\$6,550		\$11,000
60 x 168x 29" H	any shape	stationary	SPT2 6016829??S	2	4	40	TT	\$4,540	\$6,740		\$11,005
60 x 192x 29" H	rectangle	stationary	SPT2 6019229RES	2	4	40	TT	\$4,265	\$6,800		\$11,130
60 x 192x 29" H	any shape	stationary	SPT2 6019229??S	2	4	40	TT	\$4,555	\$6,905		\$11,260

**POWER & A/V OPTIONS SEE PAGES 8-20**

**SUPREME TABLE OPTIONS, SEE PAGE 163**

Bar Height TT-Base	BH	\$175 per base
Casters, locking	CS	\$20 per caster
Polished Aluminum TT-Base	CR	\$165 per base
Vertical Laser cut holes in base (not available on X-base)	WB	\$50 per base
Horizontal 4-channel ABS extruded raceway	WH	\$80 per table



Study Carrel  
12" high divider panels

1 PERSON CARRELS SHOWN

**AS OF 2021  
PRODUCT UPDATE  
See Hi5Furniture.com  
For Offering & Pricing**

**FINISHES NEEDED:** <http://hi5furniture.com/finishes/>

HPL Top: Hi5 Graded-in laminates or Non-Premium Wilsonart or Formica

Edge Color: Any Hi5 standard

Base Finish: Any Hi5 standard



## Single Sided

Seating Capacity	Carrel Size	Model Code:	Top QTY	Base QTY	Base Style / Base Spread	
1 person	24" x 30"	SPT12430RE S. (EDGE) —112PS	1	2	T- 20" / C - 22"	\$2,095
2 person	24" x 60"	SPT12460RE S. (EDGE) —212PS	1	2	T- 20" / C - 22"	\$3,235
3 person	24" x 90"	SPT12490RE S. (EDGE) —312PS	1	3	T- 20" / C - 22"	\$4,130
4 person	24" x 120"	SPT124120RE S. (EDGE) —412PS	1	3	T- 20" / C - 22"	\$5,340
5 person	24" x 150"	SPT124150RE S. (EDGE) —512PS	2	4	T- 20" / C - 22"	\$6,975
6 person	24" x 180"	SPT124180RE S. (EDGE) —612PS	2	4	T- 20" / C - 22"	\$7,955
1 person	30" x 30"	SPT13030RE S. (EDGE) —112PS	1	2	T- 26" / C - 27"	\$2,275
2 person	30" x 60"	SPT13060RE S. (EDGE) —212PS	1	2	T- 26" / C - 27"	\$3,495
3 person	30" x 90"	SPT13090RE S. (EDGE) —312PS	1	3	T- 26" / C - 27"	\$4,470
4 person	30" x 120"	SPT130120RE S. (EDGE) —412PS	1	3	T- 26" / C - 27"	\$5,750
5 person	30" x 150"	SPT130150RE S. (EDGE) —512PS	2	4	T- 26" / C - 27"	\$7,515
6 person	30" x 180"	SPT130180RE S. (EDGE) —612PS	2	4	T- 26" / C - 27"	\$8,555

## Double Sided

Seating Capacity	Carrel Size	Model Code:	Top QTY	Base QTY	Base Style / Base Spread	
2 person	48" x 30"	SPT24830RE S. (EDGE) —212PD	1	2	TT - 34"	\$3,715
4 person	48" x 60"	SPT24860RE S. (EDGE) —412PD	1	2	TT - 34"	\$5,605
6 person	48" x 90"	SPT24890RE S. (EDGE) —612PD	1	3	TT - 34"	\$7,575
8 person	48" x 120"	SPT248120RE S. (EDGE) —812PD	1	3	TT - 34"	\$9,610
10 person	48" x 150"	SPT248150RE S. (EDGE) —1012PD	2	4	TT - 34"	\$12,700
12 person	48" x 180"	SPT248180RE S. (EDGE) —1212PD	2	5	TT - 34"	\$14,445
2 person	60" x 30"	SPT26030RE S. (EDGE) —212PD	1	2	TT - 40"	\$3,810
4 person	60" x 60"	SPT26060RE S. (EDGE) —412PD	1	2	TT - 40"	\$5,875
6 person	60" x 90"	SPT26090RE S. (EDGE) —612PD	1	3	TT - 40"	\$8,155
8 person	60" x 120"	SPT260120RE S. (EDGE) —812PD	1	3	TT - 40"	\$10,330
10 person	60" x 150"	SPT260150RE S. (EDGE) —1012PD	2	4	TT - 40"	\$13,575
12 person	60" x 180"	SPT260180RE S. (EDGE) —1212PD	2	4	TT - 40"	\$15,525





Testing Carrel  
24" high divider panel

1 PERSON CARRELS SHOWN

**AS OF 2021  
PRODUCT UPDATE  
See Hi5Furniture.com  
For Offering & Pricing**

**FINISHES NEEDED:** <http://hi5furniture.com/finishes/>

HPL Top: Hi5 Graded-in laminates or Non-Premium Wilsonart or Formica

Edge Color: Any Hi5 standard

Base Finish: Any Hi5 standard



## Single Sided

Seating Capacity	Carrel Size	Model Code:	Top QTY	Base QTY	Base Style / Base Spread	
1 person	24" x 30"	SPT12430RE S. (EDGE) —124PS	1	2	T- 20" / C- 22"	\$2,295
2 person	24" x 60"	SPT12460RE S. (EDGE) —224PS	1	2	T- 20" / C- 22"	\$3,515
3 person	24" x 90"	SPT12490RE S. (EDGE) —324PS	1	3	T- 20" / C- 22"	\$5,125
4 person	24" x 120"	SPT124120RE S. (EDGE) —424PS	1	3	T- 20" / C- 22"	\$6,290
5 person	24" x 150"	SPT124150RE S. (EDGE) —524PS	2	4	T- 20" / C- 22"	\$8,190
6 person	24" x 180"	SPT124180RE S. (EDGE) —624PS	2	4	T- 20" / C- 22"	\$9,425
1 person	30" x 30"	SPT13030RE S. (EDGE) —124PS	1	2	T- 26" / C- 27"	\$2,465
2 person	30" x 60"	SPT13060RE S. (EDGE) —224PS	1	2	T- 26" / C- 27"	\$3,750
3 person	30" x 90"	SPT13090RE S. (EDGE) —324PS	1	3	T- 26" / C- 27"	\$5,435
4 person	30" x 120"	SPT130120RE S. (EDGE) —424PS	1	3	T- 26" / C- 27"	\$6,450
5 person	30" x 150"	SPT130150RE S. (EDGE) —524PS	2	4	T- 26" / C- 27"	\$8,680
6 person	30" x 180"	SPT130180RE S. (EDGE) —624PS	2	4	T- 26" / C- 27"	\$9,965

## Double Sided

Seating Capacity	Carrel Size	Model Code:	Top QTY	Base QTY	Base Style / Base Spread	
2 person	48" x 30"	SPT24830RE S. (EDGE) —224PD	1	2	TT- 34"	\$4,045
4 person	48" x 60"	SPT24860RE S. (EDGE) —424PD	1	2	TT- 34"	\$6,090
6 person	48" x 90"	SPT24890RE S. (EDGE) —624PD	1	3	TT- 34"	\$8,835
8 person	48" x 120"	SPT248120RE S. (EDGE) —824PD	1	3	TT- 34"	\$10,890
10 person	48" x 150"	SPT248150RE S. (EDGE) —1024PD	2	4	TT- 34"	\$14,305
12 person	48" x 180"	SPT248180RE S. (EDGE) —1224PD	2	4	TT- 34"	\$16,375
2 person	60" x 30"	SPT26030RE S. (EDGE) —224PD	1	2	TT- 40"	\$4,110
4 person	60" x 60"	SPT26060RE S. (EDGE) —424PD	1	2	TT- 40"	\$6,310
6 person	60" x 90"	SPT26090RE S. (EDGE) —624PD	1	3	TT- 40"	\$9,350
8 person	60" x 120"	SPT260120RE S. (EDGE) —824PD	1	3	TT- 40"	\$11,120
10 person	60" x 150"	SPT260150RE S. (EDGE) —1024PD	2	4	TT- 40"	\$15,195
12 person	60" x 180"	SPT260180RE S. (EDGE) —1224PD	2	4	TT- 40"	\$17,345

# Union 2.0 Model Choices

www.hi5furniture.com Questions? 816-774-4050  
March 1, 2018



Basic Model



Full Modesty Panel Model



Caster Model



Half Modesty Panel Model



Cubby Model

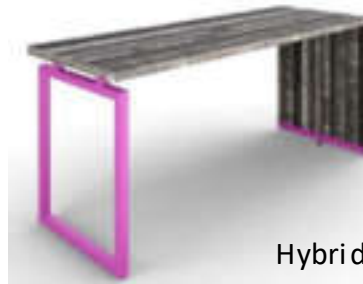

Hybrid Model



Foot Rail Model



Multi-Height Model

# Union 2.0 Basic Model

www.hi5furniture.com Questions? 816-774-4050  
 March 1, 2018



**FINISHES NEEDED:** <http://hi5furniture.com/finishes/>  
 HPL Color: Hi5 Graded-in laminates or Non-Premium Wilsonart or Formica  
 Edge Color: Hi5 Graded-in laminates or Non-Premium Wilsonart or Formica  
 Accent Laminate Color, if any.  
 Panel Base Bracket Color: Any Hi5 standard

Table Size	Model Code:	Base QTY	Price for: Basic Model	Upcharge for VDL/Premium Laminate	Upcharge for Color Core	Approx. Weight
24 x 60 x 29 high	UN2 L 246029RES.L8	2	\$5,160	\$1,030	\$1,805	241
24 x 60 x 36 high	UN2 L 246036RES.L8	2	\$5,285	\$1,055	\$1,850	257
24 x 60 x 42 high	UN2 L 246042RES.L8	2	\$5,440	\$1,090	\$1,905	272
24 x 72 x 29 high	UN2 L 247229RES.L8	2	\$5,600	\$1,120	\$1,960	256
24 x 72 x 36 high	UN2 L 247236RES.L8	2	\$5,660	\$1,130	\$1,980	272
24 x 72 x 42 high	UN2 L 247242RES.L8	2	\$5,785	\$1,155	\$2,025	287
24 x 84 x 29 high	UN2 L 248429RES.L8	2	\$5,850	\$1,170	\$2,045	271
24 x 84 x 36 high	UN2 L 248436RES.L8	2	\$5,880	\$1,175	\$2,060	287
24 x 84 x 42 high	UN2 L 248442RES.L8	2	\$5,910	\$1,180	\$2,070	302
24 x 96 x 29 high	UN2 L 249629RES.L8	2	\$5,975	\$1,195	\$2,090	286
24 x 96 x 36 high	UN2 L 249636RES.L8	2	\$6,035	\$1,205	\$2,110	302
24 x 96 x 42 high	UN2 L 249642RES.L8	2	\$6,100	\$1,220	\$2,135	317
24 x 120 x 29 high	UN2 L 2412029RES.L8	2	\$6,160	\$1,230	\$2,155	316
24 x 120 x 36 high	UN2 L 2412036RES.L8	2	\$6,225	\$1,245	\$2,180	332
24 x 120 x 42 high	UN2 L 2412042RES.L8	2	\$6,285	\$1,255	\$2,200	347
24 x 144 x 29 high	UN2 L 2414429RES.L8	3	\$8,985	\$1,795	\$3,145	449
24 x 144 x 36 high	UN2 L 2414436RES.L8	3	\$9,050	\$1,810	\$3,170	474
24 x 144 x 42 high	UN2 L 2414442RES.L8	3	\$9,110	\$1,820	\$3,190	497
24 x 168 x 29 high	UN2 L 2416829RES.L8	3	\$10,360	\$2,070	\$3,625	479
24 x 168 x 36 high	UN2 L 2416836RES.L8	3	\$10,455	\$2,090	\$3,660	504
24 x 168 x 42 high	UN2 L 2416842RES.L8	3	\$10,550	\$2,110	\$3,690	527

FOR POWER & A/V OPTIONS  
 SEE PAGES 8-20



Power location code includes location on the table and the orientation of the power box.

Use these codes for mounting Cove power into Union panel bases.

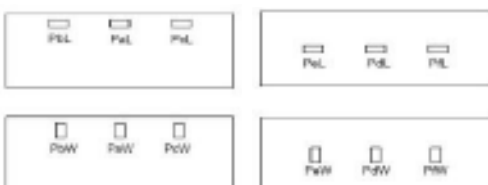

# Union 2.0 Basic Model

www.hi5furniture.com Questions? 816-774-4050  
March 1, 2018



**FINISHES NEEDED:** <http://hi5furniture.com/finishes/>  
HPL Color: Hi5 Graded-in laminates or Non-Premium Wilsonart or Formica  
Edge Color: Hi5 Graded-in laminates or Non-Premium Wilsonart or Formica  
Accent Laminate Color, if any.  
Panel Base Bracket Color: Any Hi5 standard

Table Size	Model Code:	Base QTY	Price for: Basic Model	Upcharge for VDL/Premium Laminate	Upcharge for Color Core	Approx. Weight
30 x 60 x 29 high	UN2 L 306029RES.L8	2	\$5,350	\$1,070	\$1,870	279
30 x 60 x 36 high	UN2 L 306036RES.L8	2	\$5,410	\$1,080	\$1,895	298
30 x 60 x 42 high	UN2 L 306042RES.L8	2	\$5,660	\$1,130	\$1,980	316
30 x 72 x 29 high	UN2 L 307229RES.L8	2	\$5,785	\$1,155	\$2,025	295
30 x 72 x 36 high	UN2 L 307236RES.L8	2	\$5,850	\$1,170	\$2,045	317
30 x 72 x 42 high	UN2 L 307242RES.L8	2	\$5,910	\$1,180	\$2,070	335
30 x 84 x 29 high	UN2 L 308429RES.L8	2	\$5,975	\$1,195	\$2,090	313
30 x 84 x 36 high	UN2 L 308436RES.L8	2	\$6,035	\$1,205	\$2,110	335
30 x 84 x 42 high	UN2 L 308442RES.L8	2	\$6,100	\$1,220	\$2,135	354
30 x 96 x 29 high	UN2 L 309629RES.L8	2	\$6,160	\$1,230	\$2,155	332
30 x 96 x 36 high	UN2 L 309636RES.L8	2	\$6,225	\$1,245	\$2,180	354
30 x 96 x 42 high	UN2 L 309642RES.L8	2	\$6,285	\$1,255	\$2,200	373
30 x 120 x 29 high	UN2 L 3012029RES.L8	2	\$6,350	\$1,270	\$2,225	370
30 x 120 x 36 high	UN2 L 3012036RES.L8	2	\$6,410	\$1,280	\$2,245	392
30 x 120 x 42 high	UN2 L 3012042RES.L8	2	\$6,475	\$1,295	\$2,265	410
30 x 144 x 29 high	UN2 L 3014429RES.L8	3	\$9,735	\$1,945	\$3,405	519
30 x 144 x 36 high	UN2 L 3014436RES.L8	3	\$9,800	\$1,960	\$3,430	552
30 x 144 x 42 high	UN2 L 3014442RES.L8	3	\$9,860	\$1,970	\$3,450	580
30 x 168 x 29 high	UN2 L 3016829RES.L8	3	\$10,550	\$2,110	\$3,690	557
30 x 168 x 36 high	UN2 L 3016836RES.L8	3	\$10,610	\$2,120	\$3,715	590
30 x 168 x 42 high	UN2 L 3016842RES.L8	3	\$10,675	\$2,135	\$3,735	617

FOR POWER & A/V OPTIONS  
SEE PAGES 8-20



Power location code includes location on the table and the orientation of the power box.

Use these codes for mounting Cove power into Union panel bases.

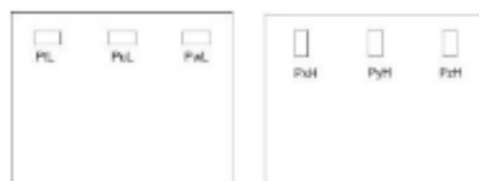

# Union 2.0 Basic Model

www.hi5furniture.com Questions? 816-774-4050  
March 1, 2018



**FINISHES NEEDED:** <http://hi5furniture.com/finishes/>  
HPL Color: Hi5 Graded-in laminates or Non-Premium Wilsonart or Formica  
Edge Color: Hi5 Graded-in laminates or Non-Premium Wilsonart or Formica  
Accent Laminate Color, if any.  
Panel Base Bracket Color: Any Hi5 standard

Table Size	Model Code:	Base QTY	Price for: Basic Model	Upcharge for VDL/Premium Laminate	Upcharge for Color Core	Approx. Weight
36 x 60 x 29 high	UN2 L 366029RES.L8	2	\$5,535	\$1,105	\$1,935	312
36 x 60 x 36 high	UN2 L 366036RES.L8	2	\$5,600	\$1,120	\$1,960	338
36 x 60 x 42 high	UN2 L 366042RES.L8	2	\$5,850	\$1,170	\$2,045	361
36 x 72 x 29 high	UN2 L 367229RES.L8	2	\$5,975	\$1,195	\$2,090	334
36 x 72 x 36 high	UN2 L 367236RES.L8	2	\$6,035	\$1,205	\$2,110	361
36 x 72 x 42 high	UN2 L 367242RES.L8	2	\$6,100	\$1,220	\$2,135	383
36 x 84 x 29 high	UN2 L 368429RES.L8	2	\$6,160	\$1,230	\$2,155	357
36 x 84 x 36 high	UN2 L 368436RES.L8	2	\$6,225	\$1,245	\$2,180	383
36 x 84 x 42 high	UN2 L 368442RES.L8	2	\$6,285	\$1,255	\$2,200	406
36 x 96 x 29 high	UN2 L 369629RES.L8	2	\$6,350	\$1,270	\$2,225	379
36 x 96 x 36 high	UN2 L 369636RES.L8	2	\$6,410	\$1,280	\$2,245	406
36 x 96 x 42 high	UN2 L 369642RES.L8	2	\$6,475	\$1,295	\$2,265	428
36 x 120 x 29 high	UN2 L 3612029RES.L8	2	\$6,660	\$1,330	\$2,330	424
36 x 120 x 36 high	UN2 L 3612036RES.L8	2	\$6,725	\$1,345	\$2,355	451
36 x 120 x 42 high	UN2 L 3612042RES.L8	2	\$6,785	\$1,355	\$2,375	473
36 x 144 x 29 high	UN2 L 3614429RES.L8	3	\$10,675	\$2,135	\$3,735	590
36 x 144 x 36 high	UN2 L 3614436RES.L8	3	\$10,735	\$2,145	\$3,755	629
36 x 144 x 42 high	UN2 L 3614442RES.L8	3	\$10,800	\$2,160	\$3,780	663
36 x 168 x 29 high	UN2 L 3616829RES.L8	3	\$11,485	\$2,295	\$4,020	635
36 x 168 x 36 high	UN2 L 3616836RES.L8	3	\$11,550	\$2,310	\$4,040	674
36 x 168 x 42 high	UN2 L 3616842RES.L8	3	\$11,610	\$2,320	\$4,065	708

FOR POWER & A/V OPTIONS  
SEE PAGES 8-20



Power location code includes location on the table and the orientation of the power box.

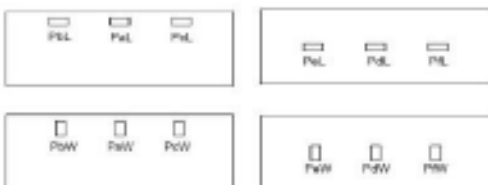

Use these codes for mounting Cove power into Union panel bases.

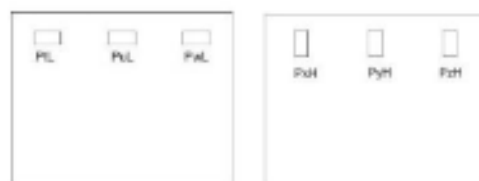

# Union 2.0 Basic Model

www.hi5furniture.com Questions? 816-774-4050

March 1, 2018



**FINISHES NEEDED:** <http://hi5furniture.com/finishes/>

HPL Color: Hi5 Graded-in laminates or Non-Premium Wilsonart or Formica  
Edge Color: Hi5 Graded-in laminates or Non-Premium Wilsonart or Formica  
Accent Laminate Color, if any.

Panel Base Bracket Color: Any Hi5 standard

Table Size	Model Code:	Base QTY	Price for: Basic Model	Upcharge for VDL/Premium Laminate	Upcharge for Color Core	Approx. Weight
42 x 60 x 29 high	UN2L426029RES.L8	2	\$5,850	\$1,170	\$2,045	347
42 x 60 x 36 high	UN2L426036RES.L8	2	\$5,910	\$1,180	\$2,070	378
42 x 60 x 42 high	UN2L426042RES.L8	2	\$6,160	\$1,230	\$2,155	404
42 x 72 x 29 high	UN2L427229RES.L8	2	\$6,285	\$1,255	\$2,200	374
42 x 72 x 36 high	UN2L427236RES.L8	2	\$6,350	\$1,270	\$2,225	404
42 x 72 x 42 high	UN2L427242RES.L8	2	\$6,410	\$1,280	\$2,245	430
42 x 84 x 29 high	UN2L428429RES.L8	2	\$6,785	\$1,355	\$2,375	400
42 x 84 x 36 high	UN2L428436RES.L8	2	\$6,850	\$1,370	\$2,400	430
42 x 84 x 42 high	UN2L428442RES.L8	2	\$6,910	\$1,380	\$2,420	457
42 x 96 x 29 high	UN2L429629RES.L8	2	\$6,975	\$1,395	\$2,440	430
42 x 96 x 36 high	UN2L429636RES.L8	2	\$7,035	\$1,405	\$2,460	460
42 x 96 x 42 high	UN2L429642RES.L8	2	\$7,100	\$1,420	\$2,485	487
42 x 120 x 29 high	UN2L4212029RES.L8	2	\$7,600	\$1,520	\$2,660	479
42 x 120 x 36 high	UN2L4212036RES.L8	2	\$7,660	\$1,530	\$2,680	509
42 x 120 x 42 high	UN2L4212042RES.L8	2	\$7,725	\$1,545	\$2,705	535
42 x 144 x 29 high	UN2L4214429RES.L8	3	\$11,925	\$2,385	\$4,175	660
42 x 144 x 36 high	UN2L4214436RES.L8	3	\$11,985	\$2,395	\$4,195	706
42 x 144 x 42 high	UN2L4214442RES.L8	3	\$12,050	\$2,410	\$4,220	745
42 x 168 x 29 high	UN2L4216829RES.L8	3	\$12,735	\$2,545	\$4,455	713
42 x 168 x 36 high	UN2L4216836RES.L8	3	\$12,800	\$2,560	\$4,480	758
42 x 168 x 42 high	UN2L4216842RES.L8	3	\$12,860	\$2,570	\$4,500	798

FOR POWER & A/V OPTIONS  
SEE PAGES 8-20



Power location code includes location on the table and the orientation of the power box.

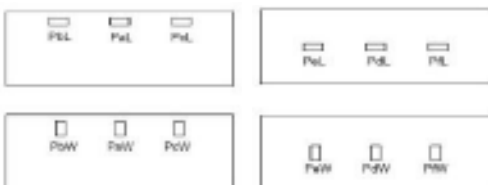

Use these codes for mounting Cove power into Union panel bases.

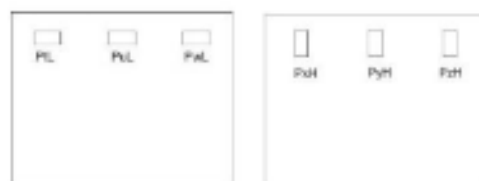

# Union 2.0 Basic Model

www.hi5furniture.com Questions? 816-774-4050

March 1, 2018



**FINISHES NEEDED:** <http://hi5furniture.com/finishes/>

HPL Color: Hi5 Graded-in laminates or Non-Premium Wilsonart or Formica  
Edge Color: Hi5 Graded-in laminates or Non-Premium Wilsonart or Formica  
Accent Laminate Color, if any.

Panel Base Bracket Color: Any Hi5 standard

Table Size	Model Code:	Base QTY	Price for: Basic Model	Upcharge for VDL/Premium Laminate	Upcharge for Color Core	Approx. Weight
48 x 60 x 29 high	UN2L486029RES.L8	2	\$6,160	\$1,230	\$2,155	366
48 x 60 x 36 high	UN2L486036RES.L8	2	\$6,225	\$1,245	\$2,180	397
48 x 60 x 42 high	UN2L486042RES.L8	2	\$6,475	\$1,295	\$2,265	423
48 x 72 x 29 high	UN2L487229RES.L8	2	\$6,600	\$1,320	\$2,310	396
48 x 72 x 36 high	UN2L487236RES.L8	2	\$6,660	\$1,330	\$2,330	427
48 x 72 x 42 high	UN2L487242RES.L8	2	\$6,725	\$1,345	\$2,355	453
48 x 84 x 29 high	UN2L488429RES.L8	2	\$7,410	\$1,480	\$2,595	426
48 x 84 x 36 high	UN2L488436RES.L8	2	\$7,475	\$1,495	\$2,615	457
48 x 84 x 42 high	UN2L488442RES.L8	2	\$7,535	\$1,505	\$2,635	483
48 x 96 x 29 high	UN2L489629RES.L8	2	\$7,600	\$1,520	\$2,660	456
48 x 96 x 36 high	UN2L489636RES.L8	2	\$7,660	\$1,530	\$2,680	487
48 x 96 x 42 high	UN2L489642RES.L8	2	\$7,725	\$1,545	\$2,705	513
48 x 120 x 29 high	UN2L4812029RES.L8	2	\$8,535	\$1,705	\$2,985	516
48 x 120 x 36 high	UN2L4812036RES.L8	2	\$8,600	\$1,720	\$3,010	547
48 x 120 x 42 high	UN2L4812042RES.L8	2	\$8,660	\$1,730	\$3,030	573
48 x 144 x 29 high	UN2L4814429RES.L8	3	\$14,410	\$2,880	\$5,045	705
48 x 144 x 36 high	UN2L4814436RES.L8	3	\$14,480	\$2,895	\$5,070	751
48 x 144 x 42 high	UN2L4814442RES.L8	3	\$14,550	\$2,910	\$5,095	790
48 x 168 x 29 high	UN2L4816829RES.L8	3	\$15,320	\$3,065	\$5,360	765
48 x 168 x 36 high	UN2L4816836RES.L8	3	\$15,390	\$3,080	\$5,385	811
48 x 168 x 42 high	UN2L4816842RES.L8	3	\$15,460	\$3,090	\$5,410	850

FOR POWER & A/V OPTIONS  
SEE PAGES 8-20



Power location code includes location on the table and the orientation of the power box.



Use these codes for mounting Cove power into Union panel bases.

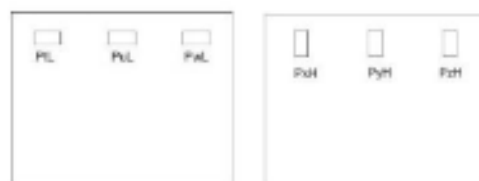

# Union 2.0 Basic Model

www.hi5furniture.com Questions? 816-774-4050

March 1, 2018



**FINISHES NEEDED:** <http://hi5furniture.com/finishes/>

HPL Color: Hi5 Graded-in laminates or Non-Premium Wilsonart or Formica  
Edge Color: Hi5 Graded-in laminates or Non-Premium Wilsonart or Formica  
Accent Laminate Color, if any.

Panel Base Bracket Color: Any Hi5 standard

Table Size	Model Code:	Base QTY	Price for: Basic Model	Upcharge for VDL/Premium Laminate	Upcharge for Color Core	Approx. Weight
60 x 60 x 29 high	UN2 L 606029SQS.L8	2	\$7,095	\$1,420	N/A	454
60 x 60 x 36 high	UN2 L 606036SQS.L8	2	\$7,165	\$1,435	N/A	498
60 x 60 x 42 high	UN2 L 606042SQS.L8	2	\$7,445	\$1,490	N/A	535
60 x 72 x 29 high	UN2 L 607229RES.L8	2	\$7,585	\$1,515	N/A	492
60 x 72 x 36 high	UN2 L 607236RES.L8	2	\$7,655	\$1,530	N/A	535
60 x 72 x 42 high	UN2 L 607242RES.L8	2	\$7,725	\$1,545	N/A	573
60 x 84 x 29 high	UN2 L 608429RES.L8	2	\$8,845	\$1,770	N/A	529
60 x 84 x 36 high	UN2 L 608436RES.L8	2	\$8,915	\$1,785	N/A	573
60 x 84 x 42 high	UN2 L 608442RES.L8	2	\$8,985	\$1,795	N/A	610
60 x 96 x 29 high	UN2 L 609629RES.L8	2	\$9,055	\$1,810	N/A	567
60 x 96 x 36 high	UN2 L 609636RES.L8	2	\$9,125	\$1,825	N/A	610
60 x 96 x 42 high	UN2 L 609642RES.L8	2	\$9,195	\$1,840	N/A	648
60 x 120 x 29 high	UN2 L 6012029RES.L8	2	\$10,455	\$2,090	N/A	642
60 x 120 x 36 high	UN2 L 6012036RES.L8	2	\$10,525	\$2,105	N/A	685
60 x 120 x 42 high	UN2 L 6012042RES.L8	2	\$10,595	\$2,120	N/A	723
60 x 144 x 29 high	UN2 L 6014429RES.L8	3	\$15,810	\$3,160	N/A	871
60 x 144 x 36 high	UN2 L 6014436RES.L8	3	\$15,880	\$3,175	N/A	937
60 x 144 x 42 high	UN2 L 6014442RES.L8	3	\$15,950	\$3,190	N/A	993
60 x 168 x 29 high	UN2 L 6016829RES.L8	3	\$16,720	\$3,345	N/A	946
60 x 168 x 36 high	UN2 L 6016836RES.L8	3	\$16,790	\$3,360	N/A	1012
60 x 168 x 42 high	UN2 L 6016842RES.L8	3	\$16,860	\$3,370	N/A	1068

FOR POWER & A/V OPTIONS  
SEE PAGES 8-20



Power location code includes location on the table and the orientation of the power box.

Use these codes for mounting Cove power into Union panel bases.

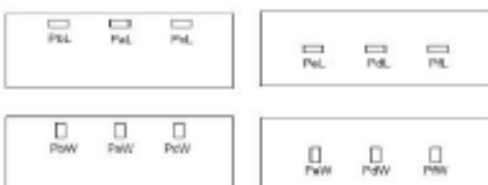



# Union 2.0 Locking Industrial Casters

www.hi5furniture.com Questions? 816-774-4050

March 1, 2018



**FINISHES NEEDED:** <http://hi5furniture.com/finishes/>

HPL Color: Hi5 Graded-in laminates or Non-Premium Wilsonart or Formica  
Edge Color: Hi5 Graded-in laminates or Non-Premium Wilsonart or Formica  
Accent Laminate Color, if any.

Panel Base Bracket Color: Any Hi5 standard

Stabilizer Beam Color: Any Hi5 standard

Table Size	Model Code:	Base QTY	Price for: Locking Casters	Upcharge for VDL/Premium Laminate	Upcharge for Color Core	Approx. Weight
24 x 60 x 29 high	UN2 L 246029RES.L8-CSI	2	\$6,160	\$1,030	\$1,805	316
24 x 60 x 36 high	UN2 L 246036RES.L8-CSI	2	\$6,285	\$1,055	\$1,850	332
24 x 60 x 42 high	UN2 L 246042RES.L8-CSI	2	\$6,440	\$1,090	\$1,905	347
24 x 72 x 29 high	UN2 L 247229RES.L8-CSI	2	\$6,600	\$1,120	\$1,960	348
24 x 72 x 36 high	UN2 L 247236RES.L8-CSI	2	\$6,660	\$1,130	\$1,980	364
24 x 72 x 42 high	UN2 L 247242RES.L8-CSI	2	\$6,785	\$1,155	\$2,025	379
24 x 84 x 29 high	UN2 L 248429RES.L8-CSI	2	\$6,850	\$1,170	\$2,045	379
24 x 84 x 36 high	UN2 L 248436RES.L8-CSI	2	\$6,880	\$1,175	\$2,060	395
24 x 84 x 42 high	UN2 L 248442RES.L8-CSI	2	\$6,910	\$1,180	\$2,070	410
24 x 96 x 29 high	UN2 L 249629RES.L8-CSI	2	\$6,975	\$1,195	\$2,090	411
24 x 96 x 36 high	UN2 L 249636RES.L8-CSI	2	\$7,035	\$1,205	\$2,110	427
24 x 96 x 42 high	UN2 L 249642RES.L8-CSI	2	\$7,100	\$1,220	\$2,135	442
24 x 120 x 29 high	UN2 L 2412029RES.L8-CSI	2	\$7,160	\$1,230	\$2,155	474
24 x 120 x 36 high	UN2 L 2412036RES.L8-CSI	2	\$7,225	\$1,245	\$2,180	490
24 x 120 x 42 high	UN2 L 2412042RES.L8-CSI	2	\$7,285	\$1,255	\$2,200	505
24 x 144 x 29 high	UN2 L 2414429RES.L8-CSI	3	\$10,940	\$1,795	\$3,145	636
24 x 144 x 36 high	UN2 L 2414436RES.L8-CSI	3	\$11,005	\$1,810	\$3,170	661
24 x 144 x 42 high	UN2 L 2414442RES.L8-CSI	3	\$11,065	\$1,820	\$3,190	684
24 x 168 x 29 high	UN2 L 2416829RES.L8-CSI	3	\$12,315	\$2,070	\$3,625	699
24 x 168 x 36 high	UN2 L 2416836RES.L8-CSI	3	\$12,410	\$2,090	\$3,660	724
24 x 168 x 42 high	UN2 L 2416842RES.L8-CSI	3	\$12,505	\$2,110	\$3,690	747

FOR POWER & A/V OPTIONS  
SEE PAGES 8-20



Power location code includes location on the table and the orientation of the power box.

Use these codes for mounting Cove power into Union panel bases.

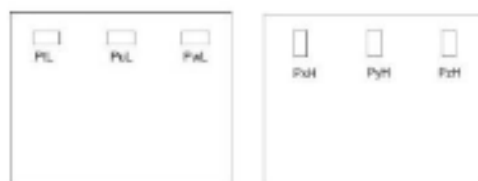

# Union 2.0 Locking Industrial Casters

www.hi5furniture.com Questions? 816-774-4050

March 1, 2018



**FINISHES NEEDED:** <http://hi5furniture.com/finishes/>

HPL Color: Hi5 Graded-in laminates or Non-Premium Wilsonart or Formica  
Edge Color: Hi5 Graded-in laminates or Non-Premium Wilsonart or Formica  
Accent Laminate Color, if any.

Panel Base Bracket Color: Any Hi5 standard

Stabilizer Beam Color: Any Hi5 standard

Table Size	Model Code:	Base QTY	Price for: Locking Casters	Upcharge for VDL/Premium Laminate	Upcharge for Color Core	Approx. Weight
30 x 60 x 29 high	UN2 L 306029RES.L8-CSI	2	\$6,350	\$1,070	\$1,870	354
30 x 60 x 36 high	UN2 L 306036RES.L8-CSI	2	\$6,410	\$1,080	\$1,895	373
30 x 60 x 42 high	UN2 L 306042RES.L8-CSI	2	\$6,660	\$1,130	\$1,980	391
30 x 72 x 29 high	UN2 L 307229RES.L8-CSI	2	\$6,785	\$1,155	\$2,025	387
30 x 72 x 36 high	UN2 L 307236RES.L8-CSI	2	\$6,850	\$1,170	\$2,045	409
30 x 72 x 42 high	UN2 L 307242RES.L8-CSI	2	\$6,910	\$1,180	\$2,070	427
30 x 84 x 29 high	UN2 L 308429RES.L8-CSI	2	\$6,975	\$1,195	\$2,090	421
30 x 84 x 36 high	UN2 L 308436RES.L8-CSI	2	\$7,035	\$1,205	\$2,110	443
30 x 84 x 42 high	UN2 L 308442RES.L8-CSI	2	\$7,100	\$1,220	\$2,135	462
30 x 96 x 29 high	UN2 L 309629RES.L8-CSI	2	\$7,160	\$1,230	\$2,155	457
30 x 96 x 36 high	UN2 L 309636RES.L8-CSI	2	\$7,225	\$1,245	\$2,180	479
30 x 96 x 42 high	UN2 L 309642RES.L8-CSI	2	\$7,285	\$1,255	\$2,200	498
30 x 120 x 29 high	UN2 L 3012029RES.L8-CSI	2	\$7,350	\$1,270	\$2,225	528
30 x 120 x 36 high	UN2 L 3012036RES.L8-CSI	2	\$7,410	\$1,280	\$2,245	550
30 x 120 x 42 high	UN2 L 3012042RES.L8-CSI	2	\$7,475	\$1,295	\$2,265	568
30 x 144 x 29 high	UN2 L 3014429RES.L8-CSI	3	\$11,690	\$1,945	\$3,405	706
30 x 144 x 36 high	UN2 L 3014436RES.L8-CSI	3	\$11,755	\$1,960	\$3,430	739
30 x 144 x 42 high	UN2 L 3014442RES.L8-CSI	3	\$11,815	\$1,970	\$3,450	767
30 x 168 x 29 high	UN2 L 3016829RES.L8-CSI	3	\$12,505	\$2,110	\$3,690	777
30 x 168 x 36 high	UN2 L 3016836RES.L8-CSI	3	\$12,565	\$2,120	\$3,715	810
30 x 168 x 42 high	UN2 L 3016842RES.L8-CSI	3	\$12,630	\$2,135	\$3,735	837

FOR POWER & A/V OPTIONS  
SEE PAGES 8-20



Power location code includes location on the table and the orientation of the power box.

Use these codes for mounting Cove power into Union panel bases.



# Union 2.0 Locking Industrial Casters

www.hi5furniture.com Questions? 816-774-4050

March 1, 2018



**FINISHES NEEDED:** <http://hi5furniture.com/finishes/>

HPL Color: Hi5 Graded-in laminates or Non-Premium Wilsonart or Formica  
Edge Color: Hi5 Graded-in laminates or Non-Premium Wilsonart or Formica  
Accent Laminate Color, if any.

Panel Base Bracket Color: Any Hi5 standard

Stabilizer Beam Color: Any Hi5 standard

Table Size	Model Code:	Base QTY	Price for: Locking Casters	Upcharge for VDL/Premium Laminate	Upcharge for Color Core	Approx. Weight
36 x 60 x 29 high	UN2 L 366029RES.L8-CSI	2	\$6,535	\$1,105	\$1,935	387
36 x 60 x 36 high	UN2 L 366036RES.L8-CSI	2	\$6,600	\$1,120	\$1,960	413
36 x 60 x 42 high	UN2 L 366042RES.L8-CSI	2	\$6,850	\$1,170	\$2,045	436
36 x 72 x 29 high	UN2 L 367229RES.L8-CSI	2	\$6,975	\$1,195	\$2,090	426
36 x 72 x 36 high	UN2 L 367236RES.L8-CSI	2	\$7,035	\$1,205	\$2,110	453
36 x 72 x 42 high	UN2 L 367242RES.L8-CSI	2	\$7,100	\$1,220	\$2,135	475
36 x 84 x 29 high	UN2 L 368429RES.L8-CSI	2	\$7,160	\$1,230	\$2,155	465
36 x 84 x 36 high	UN2 L 368436RES.L8-CSI	2	\$7,225	\$1,245	\$2,180	491
36 x 84 x 42 high	UN2 L 368442RES.L8-CSI	2	\$7,285	\$1,255	\$2,200	514
36 x 96 x 29 high	UN2 L 369629RES.L8-CSI	2	\$7,350	\$1,270	\$2,225	504
36 x 96 x 36 high	UN2 L 369636RES.L8-CSI	2	\$7,410	\$1,280	\$2,245	531
36 x 96 x 42 high	UN2 L 369642RES.L8-CSI	2	\$7,475	\$1,295	\$2,265	553
36 x 120 x 29 high	UN2 L 3612029RES.L8-CSI	2	\$7,660	\$1,330	\$2,330	582
36 x 120 x 36 high	UN2 L 3612036RES.L8-CSI	2	\$7,725	\$1,345	\$2,355	609
36 x 120 x 42 high	UN2 L 3612042RES.L8-CSI	2	\$7,785	\$1,355	\$2,375	631
36 x 144 x 29 high	UN2 L 3614429RES.L8-CSI	3	\$12,630	\$2,135	\$3,735	777
36 x 144 x 36 high	UN2 L 3614436RES.L8-CSI	3	\$12,690	\$2,145	\$3,755	816
36 x 144 x 42 high	UN2 L 3614442RES.L8-CSI	3	\$12,755	\$2,160	\$3,780	850
36 x 168 x 29 high	UN2 L 3616829RES.L8-CSI	3	\$13,440	\$2,295	\$4,020	855
36 x 168 x 36 high	UN2 L 3616836RES.L8-CSI	3	\$13,505	\$2,310	\$4,040	894
36 x 168 x 42 high	UN2 L 3616842RES.L8-CSI	3	\$13,565	\$2,320	\$4,065	928

FOR POWER & A/V OPTIONS  
SEE PAGES 8-20



Power location code includes location on the table and the orientation of the power box.

Use these codes for mounting Cove power into Union panel bases.

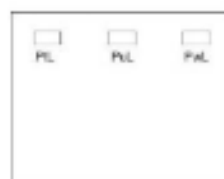

# Union 2.0 Locking Industrial Casters

www.hi5furniture.com Questions? 816-774-4050

March 1, 2018



**FINISHES NEEDED:** <http://hi5furniture.com/finishes/>

HPL Color: Hi5 Graded-in laminates or Non-Premium Wilsonart or Formica  
Edge Color: Hi5 Graded-in laminates or Non-Premium Wilsonart or Formica  
Accent Laminate Color, if any.

Panel Base Bracket Color: Any Hi5 standard

Stabilizer Beam Color: Any Hi5 standard

Table Size	Model Code:	Base QTY	Price for: Locking Casters	Upcharge for VDL/Premium Laminate	Upcharge for Color Core	Approx. Weight
42 x 60 x 29 high	UN2L426029RES.L8-CSI	2	\$6,850	\$1,170	\$2,045	422
42 x 60 x 36 high	UN2L426036RES.L8-CSI	2	\$6,910	\$1,180	\$2,070	453
42 x 60 x 42 high	UN2L426042RES.L8-CSI	2	\$7,160	\$1,230	\$2,155	479
42 x 72 x 29 high	UN2L427229RES.L8-CSI	2	\$7,285	\$1,255	\$2,200	466
42 x 72 x 36 high	UN2L427236RES.L8-CSI	2	\$7,350	\$1,270	\$2,225	496
42 x 72 x 42 high	UN2L427242RES.L8-CSI	2	\$7,410	\$1,280	\$2,245	522
42 x 84 x 29 high	UN2L428429RES.L8-CSI	2	\$7,785	\$1,355	\$2,375	508
42 x 84 x 36 high	UN2L428436RES.L8-CSI	2	\$7,850	\$1,370	\$2,400	538
42 x 84 x 42 high	UN2L428442RES.L8-CSI	2	\$7,910	\$1,380	\$2,420	565
42 x 96 x 29 high	UN2L429629RES.L8-CSI	2	\$7,975	\$1,395	\$2,440	555
42 x 96 x 36 high	UN2L429636RES.L8-CSI	2	\$8,035	\$1,405	\$2,460	585
42 x 96 x 42 high	UN2L429642RES.L8-CSI	2	\$8,100	\$1,420	\$2,485	612
42 x 120 x 29 high	UN2L4212029RES.L8-CSI	2	\$8,600	\$1,520	\$2,660	637
42 x 120 x 36 high	UN2L4212036RES.L8-CSI	2	\$8,660	\$1,530	\$2,680	667
42 x 120 x 42 high	UN2L4212042RES.L8-CSI	2	\$8,725	\$1,545	\$2,705	693
42 x 144 x 29 high	UN2L4214429RES.L8-CSI	3	\$13,880	\$2,385	\$4,175	847
42 x 144 x 36 high	UN2L4214436RES.L8-CSI	3	\$13,940	\$2,395	\$4,195	893
42 x 144 x 42 high	UN2L4214442RES.L8-CSI	3	\$14,005	\$2,410	\$4,220	932
42 x 168 x 29 high	UN2L4216829RES.L8-CSI	3	\$14,690	\$2,545	\$4,455	933
42 x 168 x 36 high	UN2L4216836RES.L8-CSI	3	\$14,755	\$2,560	\$4,480	978
42 x 168 x 42 high	UN2L4216842RES.L8-CSI	3	\$14,815	\$2,570	\$4,500	1018

FOR POWER & A/V OPTIONS  
SEE PAGES 8-20



Power location code includes location on the table and the orientation of the power box.

Use these codes for mounting Cove power into Union panel bases.

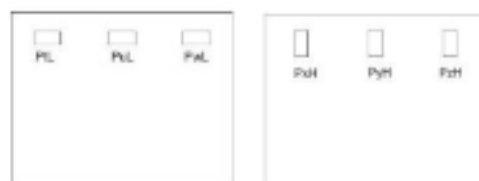
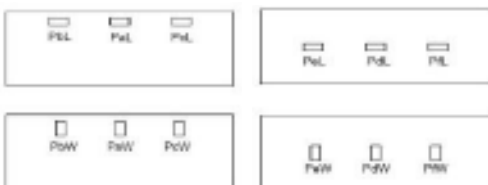

# Union 2.0 Locking Industrial Casters

www.hi5furniture.com Questions? 816-774-4050

March 1, 2018



**FINISHES NEEDED:** <http://hi5furniture.com/finishes/>

HPL Color: Hi5 Graded-in laminates or Non-Premium Wilsonart or Formica  
Edge Color: Hi5 Graded-in laminates or Non-Premium Wilsonart or Formica  
Accent Laminate Color, if any.

Panel Base Bracket Color: Any Hi5 standard

Stabilizer Beam Color: Any Hi5 standard

Table Size	Model Code:	Base QTY	Price for: Locking Casters	Upcharge for VDL/Premium Laminate	Upcharge for Color Core	Approx. Weight
48 x 60 x 29 high	UN2L486029RES.L8-CSI	2	\$7,160	\$1,230	\$2,155	441
48 x 60 x 36 high	UN2L486036RES.L8-CSI	2	\$7,225	\$1,245	\$2,180	472
48 x 60 x 42 high	UN2L486042RES.L8-CSI	2	\$7,475	\$1,295	\$2,265	498
48 x 72 x 29 high	UN2L487229RES.L8-CSI	2	\$7,600	\$1,320	\$2,310	488
48 x 72 x 36 high	UN2L487236RES.L8-CSI	2	\$7,660	\$1,330	\$2,330	519
48 x 72 x 42 high	UN2L487242RES.L8-CSI	2	\$7,725	\$1,345	\$2,355	545
48 x 84 x 29 high	UN2L488429RES.L8-CSI	2	\$8,410	\$1,480	\$2,595	534
48 x 84 x 36 high	UN2L488436RES.L8-CSI	2	\$8,475	\$1,495	\$2,615	565
48 x 84 x 42 high	UN2L488442RES.L8-CSI	2	\$8,535	\$1,505	\$2,635	591
48 x 96 x 29 high	UN2L489629RES.L8-CSI	2	\$8,600	\$1,520	\$2,660	581
48 x 96 x 36 high	UN2L489636RES.L8-CSI	2	\$8,660	\$1,530	\$2,680	612
48 x 96 x 42 high	UN2L489642RES.L8-CSI	2	\$8,725	\$1,545	\$2,705	638
48 x 120 x 29 high	UN2L4812029RES.L8-CSI	2	\$9,535	\$1,705	\$2,985	674
48 x 120 x 36 high	UN2L4812036RES.L8-CSI	2	\$9,600	\$1,720	\$3,010	705
48 x 120 x 42 high	UN2L4812042RES.L8-CSI	2	\$9,660	\$1,730	\$3,030	731
48 x 144 x 29 high	UN2L4814429RES.L8-CSI	3	\$16,365	\$2,880	\$5,045	892
48 x 144 x 36 high	UN2L4814436RES.L8-CSI	3	\$16,435	\$2,895	\$5,070	938
48 x 144 x 42 high	UN2L4814442RES.L8-CSI	3	\$16,505	\$2,910	\$5,095	977
48 x 168 x 29 high	UN2L4816829RES.L8-CSI	3	\$17,275	\$3,065	\$5,360	985
48 x 168 x 36 high	UN2L4816836RES.L8-CSI	3	\$17,345	\$3,080	\$5,385	1031
48 x 168 x 42 high	UN2L4816842RES.L8-CSI	3	\$17,415	\$3,090	\$5,410	1070

FOR POWER & A/V OPTIONS  
SEE PAGES 8-20



Power location code includes location on the table and the orientation of the power box.

Use these codes for mounting Cove power into Union panel bases.

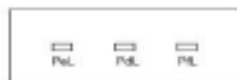

# Union 2.0 Locking Industrial Casters

www.hi5furniture.com Questions? 816-774-4050

March 1, 2018



**FINISHES NEEDED:** <http://hi5furniture.com/finishes/>

HPL Color: Hi5 Graded-in laminates or Non-Premium Wilsonart or Formica  
Edge Color: Hi5 Graded-in laminates or Non-Premium Wilsonart or Formica  
Accent Laminate Color, if any.

Panel Base Bracket Color: Any Hi5 standard

Stabilizer Beam Color: Any Hi5 standard

Table Size	Model Code:	Base QTY	Price for Locking Casters	Upcharge for VDL/Premium Laminate	Upcharge for Color Core	Approx. Weight
60 x 60 x 29 high	UN2 L 606029SQS.L8-CSI	2	\$8,095	\$1,420	N/A	529
60 x 60 x 36 high	UN2 L 606036SQS.L8-CSI	2	\$8,165	\$1,435	N/A	573
60 x 60 x 42 high	UN2 L 606042SQS.L8-CSI	2	\$8,445	\$1,490	N/A	610
60 x 72 x 29 high	UN2 L 607229RES.L8-CSI	2	\$8,585	\$1,515	N/A	584
60 x 72 x 36 high	UN2 L 607236RES.L8-CSI	2	\$8,655	\$1,530	N/A	627
60 x 72 x 42 high	UN2 L 607242RES.L8-CSI	2	\$8,725	\$1,545	N/A	665
60 x 84 x 29 high	UN2 L 608429RES.L8-CSI	2	\$9,845	\$1,770	N/A	637
60 x 84 x 36 high	UN2 L 608436RES.L8-CSI	2	\$9,915	\$1,785	N/A	681
60 x 84 x 42 high	UN2 L 608442RES.L8-CSI	2	\$9,985	\$1,795	N/A	718
60 x 96 x 29 high	UN2 L 609629RES.L8-CSI	2	\$10,055	\$1,810	N/A	692
60 x 96 x 36 high	UN2 L 609636RES.L8-CSI	2	\$10,125	\$1,825	N/A	735
60 x 96 x 42 high	UN2 L 609642RES.L8-CSI	2	\$10,195	\$1,840	N/A	773
60 x 120 x 29 high	UN2 L 6012029RES.L8-CSI	2	\$11,455	\$2,090	N/A	800
60 x 120 x 36 high	UN2 L 6012036RES.L8-CSI	2	\$11,525	\$2,105	N/A	843
60 x 120 x 42 high	UN2 L 6012042RES.L8-CSI	2	\$11,595	\$2,120	N/A	881
60 x 144 x 29 high	UN2 L 6014429RES.L8-CSI	3	\$17,765	\$3,160	N/A	1058
60 x 144 x 36 high	UN2 L 6014436RES.L8-CSI	3	\$17,835	\$3,175	N/A	1124
60 x 144 x 42 high	UN2 L 6014442RES.L8-CSI	3	\$17,905	\$3,190	N/A	1180
60 x 168 x 29 high	UN2 L 6016829RES.L8-CSI	3	\$18,675	\$3,345	N/A	1166
60 x 168 x 36 high	UN2 L 6016836RES.L8-CSI	3	\$18,745	\$3,360	N/A	1232
60 x 168 x 42 high	UN2 L 6016842RES.L8-CSI	3	\$18,815	\$3,370	N/A	1288

FOR POWER & A/V OPTIONS  
SEE PAGES 8-20



Power location code includes location on the table and the orientation of the power box.

Use these codes for mounting Cove power into Union panel bases.



# Union 2.0 Cubby – Single Sided Unit

www.hi5furniture.com Questions? 816-774-4050

March 1, 2018



**FINISHES NEEDED:** <http://hi5furniture.com/finishes/>

- HPL Color: Hi5 Graded-in laminates or Non-Premium Wilsonart or Formica
- Edge Color: Hi5 Graded-in laminates or Non-Premium Wilsonart or Formica
- Panel Base Bracket Color: Any Hi5 standard
- Cubby Corner Bracket Color: Any Hi5 standard
- Cubby Shelf & Divider Color: Hi5 Graded-in laminates or Non-Premium Wilsonart or Formica
- Cubby Back Wall Divider Color: Hi5 Graded-in laminates or Non-Premium Wilsonart or Formica

**POWER NOT INCLUDED IN PRICES BELOW.**

Table Size	Model Code:	Base QTY	Price for: Cubby	Upcharge for VDL/Premium Laminate	Upcharge for Color Core
24 x 60 x 29 high	UN2 L 246029RES.L8-CB3S	2	\$7,100	\$1,420	\$2,485
24 x 60 x 36 high	UN2 L 246036RES.L8-CB3S	2	\$7,225	\$1,445	\$2,530
24 x 60 x 42 high	UN2 L 246042RES.L8-CB3S	2	\$7,380	\$1,475	\$2,585
24 x 72 x 29 high	UN2 L 247229RES.L8-CB3S	2	\$7,540	\$1,510	\$2,640
24 x 72 x 36 high	UN2 L 247236RES.L8-CB3S	2	\$7,600	\$1,520	\$2,660
24 x 72 x 42 high	UN2 L 247242RES.L8-CB3S	2	\$7,725	\$1,545	\$2,705
24 x 84 x 29 high	UN2 L 248429RES.L8-CB3S	2	\$7,790	\$1,560	\$2,725
24 x 84 x 36 high	UN2 L 248436RES.L8-CB3S	2	\$7,820	\$1,565	\$2,735
24 x 84 x 42 high	UN2 L 248442RES.L8-CB3S	2	\$7,850	\$1,570	\$2,750
24 x 96 x 29 high	UN2 L 249629RES.L8-CB3S	2	\$7,915	\$1,585	\$2,770
24 x 96 x 36 high	UN2 L 249636RES.L8-CB3S	2	\$7,975	\$1,595	\$2,790
24 x 96 x 42 high	UN2 L 249642RES.L8-CB3S	2	\$8,040	\$1,610	\$2,815
24 x 120 x 29 high	UN2 L 2412029RES.L8-CB3S	2	\$8,100	\$1,620	\$2,835
24 x 120 x 36 high	UN2 L 2412036RES.L8-CB3S	2	\$8,165	\$1,635	\$2,860
24 x 120 x 42 high	UN2 L 2412042RES.L8-CB3S	2	\$8,225	\$1,645	\$2,880
24 x 144 x 29 high	UN2 L 2414429RES.L8-CB3S	3	\$10,935	\$2,185	\$3,825
24 x 144 x 36 high	UN2 L 2414436RES.L8-CB3S	3	\$11,000	\$2,200	\$3,850
24 x 144 x 42 high	UN2 L 2414442RES.L8-CB3S	3	\$11,060	\$2,210	\$3,870
24 x 168 x 29 high	UN2 L 2416829RES.L8-CB3S	3	\$12,310	\$2,460	\$4,310
24 x 168 x 36 high	UN2 L 2416836RES.L8-CB3S	3	\$12,405	\$2,480	\$4,340
24 x 168 x 42 high	UN2 L 2416842RES.L8-CB3S	3	\$12,500	\$2,500	\$4,375

ONLY COVE POWER AVAILABLE WITH CUBBY MODELS

SEE PAGES 12 FOR POWER BOX CONFIGURATION OPTIONS



Cove  
1-6 outlets  
2 or 4 USB  
AV Jacks Available  
Linking Available



# Union 2.0 Cubby – Single Sided Unit

www.hi5furniture.com Questions? 816-774-4050

March 1, 2018



**FINISHES NEEDED:** <http://hi5furniture.com/finishes/>

HPL Color: Hi5 Graded-in laminates or Non-Premium Wilsonart or Formica

Edge Color: Hi5 Graded-in laminates or Non-Premium Wilsonart or Formica

Panel Base Bracket Color: Any Hi5 standard

Cubby Corner Bracket Color: Any Hi5 standard

Cubby Shelf & Divider Color: Hi5 Graded-in laminates or Non-Premium Wilsonart or Formica

Cubby Back Wall Divider Color: Hi5 Graded-in laminates or Non-Premium Wilsonart or Formica

**POWER NOT INCLUDED IN PRICES BELOW.**

Table Size	Model Code:	Base QTY	Price for: Cubby	Upcharge for VDL/Premium Laminate	Upcharge for Color Core
30 x 60 x 29 high	UN2 L 306029RES.L8-CB3S	2	\$7,290	\$1,460	\$2,550
30 x 60 x 36 high	UN2 L 306036RES.L8-CB3S	2	\$7,350	\$1,470	\$2,575
30 x 60 x 42 high	UN2 L 306042RES.L8-CB3S	2	\$7,600	\$1,520	\$2,660
30 x 72 x 29 high	UN2 L 307229RES.L8-CB3S	2	\$7,725	\$1,545	\$2,705
30 x 72 x 36 high	UN2 L 307236RES.L8-CB3S	2	\$7,790	\$1,560	\$2,725
30 x 72 x 42 high	UN2 L 307242RES.L8-CB3S	2	\$7,850	\$1,570	\$2,750
30 x 84 x 29 high	UN2 L 308429RES.L8-CB3S	2	\$7,915	\$1,585	\$2,770
30 x 84 x 36 high	UN2 L 308436RES.L8-CB3S	2	\$7,975	\$1,595	\$2,790
30 x 84 x 42 high	UN2 L 308442RES.L8-CB3S	2	\$8,040	\$1,610	\$2,815
30 x 96 x 29 high	UN2 L 309629RES.L8-CB3S	2	\$8,100	\$1,620	\$2,835
30 x 96 x 36 high	UN2 L 309636RES.L8-CB3S	2	\$8,165	\$1,635	\$2,860
30 x 96 x 42 high	UN2 L 309642RES.L8-CB3S	2	\$8,225	\$1,645	\$2,880
30 x 120 x 29 high	UN2 L 3012029RES.L8-CB3S	2	\$8,290	\$1,660	\$2,900
30 x 120 x 36 high	UN2 L 3012036RES.L8-CB3S	2	\$8,350	\$1,670	\$2,925
30 x 120 x 42 high	UN2 L 3012042RES.L8-CB3S	2	\$8,415	\$1,685	\$2,945
30 x 144 x 29 high	UN2 L 3014429RES.L8-CB3S	3	\$11,685	\$2,335	\$4,090
30 x 144 x 36 high	UN2 L 3014436RES.L8-CB3S	3	\$11,750	\$2,350	\$4,115
30 x 144 x 42 high	UN2 L 3014442RES.L8-CB3S	3	\$11,810	\$2,360	\$4,135
30 x 168 x 29 high	UN2 L 3016829RES.L8-CB3S	3	\$12,500	\$2,500	\$4,375
30 x 168 x 36 high	UN2 L 3016836RES.L8-CB3S	3	\$12,560	\$2,510	\$4,395
30 x 168 x 42 high	UN2 L 3016842RES.L8-CB3S	3	\$12,625	\$2,525	\$4,420

ONLY COVE POWER AVAILABLE WITH CUBBY MODELS

SEE PAGES 12 FOR POWER BOX CONFIGURATION OPTIONS



Cove  
1-6 outlets  
2 or 4 USB  
AV Jacks Available  
Linking Available





# Union 2.0 Cubby – Double Sided Unit

www.hi5furniture.com Questions? 816-774-4050

March 1, 2018



**FINISHES NEEDED:** <http://hi5furniture.com/finishes/>

HPL Color: Hi5 Graded-in laminates or Non-Premium Wilsonart or Formica

Edge Color: Hi5 Graded-in laminates or Non-Premium Wilsonart or Formica

Panel Base Bracket Color: Any Hi5 standard

Cubby Corner Bracket Color: Any Hi5 standard

Cubby Shelf & Divider Color: Hi5 Graded-in laminates or Non-Premium Wilsonart or Formica

Cubby Back Wall Divider Color: Hi5 Graded-in laminates or Non-Premium Wilsonart or Formica

**POWER NOT INCLUDED IN PRICES BELOW.**

Table Size	Model Code:	Base QTY	Price for: Cubby	Upcharge for VDL/Premium Laminate	Upcharge for Color Core
36 x 60 x 29 high	UN2 L 366029RES.L8-CB3D	2	\$7,475	\$1,495	\$2,615
36 x 60 x 36 high	UN2 L 366036RES.L8-CB3D	2	\$7,540	\$1,510	\$2,640
36 x 60 x 42 high	UN2 L 366042RES.L8-CB3D	2	\$7,790	\$1,560	\$2,725
36 x 72 x 29 high	UN2 L 367229RES.L8-CB3D	2	\$7,915	\$1,585	\$2,770
36 x 72 x 36 high	UN2 L 367236RES.L8-CB3D	2	\$7,975	\$1,595	\$2,790
36 x 72 x 42 high	UN2 L 367242RES.L8-CB3D	2	\$8,040	\$1,610	\$2,815
36 x 84 x 29 high	UN2 L 368429RES.L8-CB3D	2	\$8,100	\$1,620	\$2,835
36 x 84 x 36 high	UN2 L 368436RES.L8-CB3D	2	\$8,165	\$1,635	\$2,860
36 x 84 x 42 high	UN2 L 368442RES.L8-CB3D	2	\$8,225	\$1,645	\$2,880
36 x 96 x 29 high	UN2 L 369629RES.L8-CB3D	2	\$8,290	\$1,660	\$2,900
36 x 96 x 36 high	UN2 L 369636RES.L8-CB3D	2	\$8,350	\$1,670	\$2,925
36 x 96 x 42 high	UN2 L 369642RES.L8-CB3D	2	\$8,415	\$1,685	\$2,945
36 x 120 x 29 high	UN2 L 3612029RES.L8-CB3D	2	\$8,600	\$1,720	\$3,010
36 x 120 x 36 high	UN2 L 3612036RES.L8-CB3D	2	\$8,665	\$1,735	\$3,035
36 x 120 x 42 high	UN2 L 3612042RES.L8-CB3D	2	\$8,725	\$1,745	\$3,055
36 x 144 x 29 high	UN2 L 3614429RES.L8-CB3D	3	\$12,625	\$2,525	\$4,420
36 x 144 x 36 high	UN2 L 3614436RES.L8-CB3D	3	\$12,685	\$2,535	\$4,440
36 x 144 x 42 high	UN2 L 3614442RES.L8-CB3D	3	\$12,750	\$2,550	\$4,465
36 x 168 x 29 high	UN2 L 3616829RES.L8-CB3D	3	\$13,435	\$2,685	\$4,700
36 x 168 x 36 high	UN2 L 3616836RES.L8-CB3D	3	\$13,500	\$2,700	\$4,725
36 x 168 x 42 high	UN2 L 3616842RES.L8-CB3D	3	\$13,560	\$2,710	\$4,745

ONLY COVE POWER AVAILABLE WITH CUBBY MODELS

SEE PAGES 12 FOR POWER BOX CONFIGURATION OPTIONS



Cove  
1-6 outlets  
2 or 4 USB  
AV Jacks Available  
Linking Available



# Union 2.0 Cubby – Double Sided Unit

www.hi5furniture.com Questions? 816-774-4050

March 1, 2018



**FINISHES NEEDED:** <http://hi5furniture.com/finishes/>

HPL Color: Hi5 Graded-in laminates or Non-Premium Wilsonart or Formica

Edge Color: Hi5 Graded-in laminates or Non-Premium Wilsonart or Formica

Panel Base Bracket Color: Any Hi5 standard

Cubby Corner Bracket Color: Any Hi5 standard

Cubby Shelf & Divider Color: Hi5 Graded-in laminates or Non-Premium Wilsonart or Formica

Cubby Back Wall Divider Color: Hi5 Graded-in laminates or Non-Premium Wilsonart or Formica

**POWER NOT INCLUDED IN PRICES BELOW.**

Table Size	Model Code:	Base QTY	Price for: Cubby	Upcharge for VDL/Premium Laminate	Upcharge for Color Core
42 x 60 x 29 high	UN2 L 426029RES.L8-CB3D	2	\$7,790	\$1,560	\$2,725
42 x 60 x 36 high	UN2 L 426036RES.L8-CB3D	2	\$7,850	\$1,570	\$2,750
42 x 60 x 42 high	UN2 L 426042RES.L8-CB3D	2	\$8,100	\$1,620	\$2,835
42 x 72 x 29 high	UN2 L 427229RES.L8-CB3D	2	\$8,225	\$1,645	\$2,880
42 x 72 x 36 high	UN2 L 427236RES.L8-CB3D	2	\$8,290	\$1,660	\$2,900
42 x 72 x 42 high	UN2 L 427242RES.L8-CB3D	2	\$8,350	\$1,670	\$2,925
42 x 84 x 29 high	UN2 L 428429RES.L8-CB3D	2	\$8,725	\$1,745	\$3,055
42 x 84 x 36 high	UN2 L 428436RES.L8-CB3D	2	\$8,790	\$1,760	\$3,075
42 x 84 x 42 high	UN2 L 428442RES.L8-CB3D	2	\$8,850	\$1,770	\$3,100
42 x 96 x 29 high	UN2 L 429629RES.L8-CB3D	2	\$8,915	\$1,785	\$3,120
42 x 96 x 36 high	UN2 L 429636RES.L8-CB3D	2	\$8,975	\$1,795	\$3,140
42 x 96 x 42 high	UN2 L 429642RES.L8-CB3D	2	\$9,040	\$1,810	\$3,165
42 x 120 x 29 high	UN2 L 4212029RES.L8-CB3D	2	\$9,540	\$1,910	\$3,340
42 x 120 x 36 high	UN2 L 4212036RES.L8-CB3D	2	\$9,600	\$1,920	\$3,360
42 x 120 x 42 high	UN2 L 4212042RES.L8-CB3D	2	\$9,665	\$1,935	\$3,385
42 x 144 x 29 high	UN2 L 4214429RES.L8-CB3D	3	\$13,875	\$2,775	\$4,855
42 x 144 x 36 high	UN2 L 4214436RES.L8-CB3D	3	\$13,935	\$2,785	\$4,875
42 x 144 x 42 high	UN2 L 4214442RES.L8-CB3D	3	\$14,000	\$2,800	\$4,900
42 x 168 x 29 high	UN2 L 4216829RES.L8-CB3D	3	\$14,685	\$2,935	\$5,140
42 x 168 x 36 high	UN2 L 4216836RES.L8-CB3D	3	\$14,750	\$2,950	\$5,165
42 x 168 x 42 high	UN2 L 4216842RES.L8-CB3D	3	\$14,810	\$2,960	\$5,185

ONLY COVE POWER AVAILABLE WITH CUBBY MODELS

SEE PAGES 12 FOR POWER BOX CONFIGURATION OPTIONS



Cove  
1-6 outlets  
2 or 4 USB  
AV Jacks Available  
Linking Available



# Union 2.0 Cubby – Double Sided Unit

www.hi5furniture.com Questions? 816-774-4050

March 1, 2018



**FINISHES NEEDED:** <http://hi5furniture.com/finishes/>

- HPL Color: Hi5 Graded-in laminates or Non-Premium Wilsonart or Formica
- Edge Color: Hi5 Graded-in laminates or Non-Premium Wilsonart or Formica
- Panel Base Bracket Color: Any Hi5 standard
- Cubby Corner Bracket Color: Any Hi5 standard
- Cubby Shelf & Divider Color: Hi5 Graded-in laminates or Non-Premium Wilsonart or Formica
- Cubby Back Wall Divider Color: Hi5 Graded-in laminates or Non-Premium Wilsonart or Formica

**POWER NOT INCLUDED IN PRICES BELOW.**

Table Size	Model Code:	Base QTY	Price for: Cubby	Upcharge for VDL/Premium Laminate	Upcharge for Color Core
48 x 60 x 29 high	UN2 L486029RES.L8-CB3D	2	\$8,100	\$1,620	\$2,835
48 x 60 x 36 high	UN2 L486036RES.L8-CB3D	2	\$8,165	\$1,635	\$2,860
48 x 60 x 42 high	UN2 L486042RES.L8-CB3D	2	\$8,415	\$1,685	\$2,945
48 x 72 x 29 high	UN2 L487229RES.L8-CB3D	2	\$8,540	\$1,710	\$2,990
48 x 72 x 36 high	UN2 L487236RES.L8-CB3D	2	\$8,600	\$1,720	\$3,010
48 x 72 x 42 high	UN2 L487242RES.L8-CB3D	2	\$8,665	\$1,735	\$3,035
48 x 84 x 29 high	UN2 L488429RES.L8-CB3D	2	\$9,350	\$1,870	\$3,275
48 x 84 x 36 high	UN2 L488436RES.L8-CB3D	2	\$9,415	\$1,885	\$3,295
48 x 84 x 42 high	UN2 L488442RES.L8-CB3D	2	\$9,475	\$1,895	\$3,315
48 x 96 x 29 high	UN2 L489629RES.L8-CB3D	2	\$9,540	\$1,910	\$3,340
48 x 96 x 36 high	UN2 L489636RES.L8-CB3D	2	\$9,600	\$1,920	\$3,360
48 x 96 x 42 high	UN2 L489642RES.L8-CB3D	2	\$9,665	\$1,935	\$3,385
48 x 120 x 29 high	UN2 L4812029RES.L8-CB3D	2	\$10,475	\$2,095	\$3,665
48 x 120 x 36 high	UN2 L4812036RES.L8-CB3D	2	\$10,540	\$2,110	\$3,690
48 x 120 x 42 high	UN2 L4812042RES.L8-CB3D	2	\$10,600	\$2,120	\$3,710
48 x 144 x 29 high	UN2 L4814429RES.L8-CB3D	3	\$16,360	\$3,270	\$5,725
48 x 144 x 36 high	UN2 L4814436RES.L8-CB3D	3	\$16,430	\$3,285	\$5,750
48 x 144 x 42 high	UN2 L4814442RES.L8-CB3D	3	\$16,500	\$3,300	\$5,775
48 x 168 x 29 high	UN2 L4816829RES.L8-CB3D	3	\$17,270	\$3,455	\$6,045
48 x 168 x 36 high	UN2 L4816836RES.L8-CB3D	3	\$17,340	\$3,470	\$6,070
48 x 168 x 42 high	UN2 L4816842RES.L8-CB3D	3	\$17,410	\$3,480	\$6,095

ONLY COVE POWER AVAILABLE WITH CUBBY MODELS

SEE PAGES 12 FOR POWER BOX CONFIGURATION OPTIONS



**Cove**  
1-6 outlets  
2 or 4 USB  
AV Jacks Available  
Linking Available



# Union 2.0 Cubby – Double Sided Unit

www.hi5furniture.com Questions? 816-774-4050

March 1, 2018



**FINISHES NEEDED:** <http://hi5furniture.com/finishes/>

- HPL Color: Hi5 Graded-in laminates or Non-Premium Wilsonart or Formica
- Edge Color: Hi5 Graded-in laminates or Non-Premium Wilsonart or Formica
- Panel Base Bracket Color: Any Hi5 standard
- Cubby Corner Bracket Color: Any Hi5 standard
- Cubby Shelf & Divider Color: Hi5 Graded-in laminates or Non-Premium Wilsonart or Formica
- Cubby Back Wall Divider Color: Hi5 Graded-in laminates or Non-Premium Wilsonart or Formica

**POWER NOT INCLUDED IN PRICES BELOW.**

Table Size	Model Code:	Base QTY	Price for: Cubby	Upcharge for VDL/Premium Laminate	Upcharge for Color Core
60 x 60 x 29 high	UN2 L 606029SQS.L8-CB3D	2	\$9,035	\$1,805	N/A
60 x 60 x 36 high	UN2 L 606036SQS.L8-CB3D	2	\$9,105	\$1,820	N/A
60 x 60 x 42 high	UN2 L 606042SQS.L8-CB3D	2	\$9,385	\$1,875	N/A
60 x 72 x 29 high	UN2 L 607229RES.L8-CB3D	2	\$9,525	\$1,905	N/A
60 x 72 x 36 high	UN2 L 607236RES.L8-CB3D	2	\$9,595	\$1,920	N/A
60 x 72 x 42 high	UN2 L 607242RES.L8-CB3D	2	\$9,665	\$1,935	N/A
60 x 84 x 29 high	UN2 L 608429RES.L8-CB3D	2	\$10,785	\$2,155	N/A
60 x 84 x 36 high	UN2 L 608436RES.L8-CB3D	2	\$10,855	\$2,170	N/A
60 x 84 x 42 high	UN2 L 608442RES.L8-CB3D	2	\$10,925	\$2,185	N/A
60 x 96 x 29 high	UN2 L 609629RES.L8-CB3D	2	\$10,995	\$2,200	N/A
60 x 96 x 36 high	UN2 L 609636RES.L8-CB3D	2	\$11,065	\$2,215	N/A
60 x 96 x 42 high	UN2 L 609642RES.L8-CB3D	2	\$11,135	\$2,225	N/A
60 x 120 x 29 high	UN2 L 6012029RES.L8-CB3D	2	\$12,395	\$2,480	N/A
60 x 120 x 36 high	UN2 L 6012036RES.L8-CB3D	2	\$12,465	\$2,495	N/A
60 x 120 x 42 high	UN2 L 6012042RES.L8-CB3D	2	\$12,535	\$2,505	N/A
60 x 144 x 29 high	UN2 L 6014429RES.L8-CB3D	3	\$17,760	\$3,550	N/A
60 x 144 x 36 high	UN2 L 6014436RES.L8-CB3D	3	\$17,830	\$3,565	N/A
60 x 144 x 42 high	UN2 L 6014442RES.L8-CB3D	3	\$17,900	\$3,580	N/A
60 x 168 x 29 high	UN2 L 6016829RES.L8-CB3D	3	\$18,670	\$3,735	N/A
60 x 168 x 36 high	UN2 L 6016836RES.L8-CB3D	3	\$18,740	\$3,750	N/A
60 x 168 x 42 high	UN2 L 6016842RES.L8-CB3D	3	\$18,810	\$3,760	N/A

ONLY COVE POWER AVAILABLE WITH CUBBY MODELS

SEE PAGES 12 FOR POWER BOX CONFIGURATION OPTIONS



**Cove**  
1-6 outlets  
2 or 4 USB  
AV Jacks Available  
Linking Available



# Union 2.0 Foot Rail

www.hi5furniture.com Questions? 816-774-4050

March 1, 2018



**FINISHES NEEDED:** <http://hi5furniture.com/finishes/>

HPL Color: Hi5 Graded-in laminates or Non-Premium Wilsonart or Formica  
Edge Color: Hi5 Graded-in laminates or Non-Premium Wilsonart or Formica  
Accent Laminate Color, if any.

Panel Base Bracket Color: Any Hi5 standard

Foot Rail Color: Any Hi5 standard

Table Size	Model Code:	Base QTY	Price for: Foot Rail	Upcharge for VDL/Premium Laminate	Upcharge for Color Core	Upcharge for Perimeter Foot Rails Suffix -FTP
24 x 60 x 29 high	UN2L246029RES.L8-FT	2	\$5,860	\$1,030	\$1,805	\$700
24 x 60 x 36 high	UN2L246036RES.L8-FT	2	\$5,985	\$1,055	\$1,850	\$700
24 x 60 x 42 high	UN2L246042RES.L8-FT	2	\$6,140	\$1,090	\$1,905	\$700
24 x 72 x 29 high	UN2L247229RES.L8-FT	2	\$6,300	\$1,120	\$1,960	\$700
24 x 72 x 36 high	UN2L247236RES.L8-FT	2	\$6,360	\$1,130	\$1,980	\$700
24 x 72 x 42 high	UN2L247242RES.L8-FT	2	\$6,485	\$1,155	\$2,025	\$700
24 x 84 x 29 high	UN2L248429RES.L8-FT	2	\$6,550	\$1,170	\$2,045	\$700
24 x 84 x 36 high	UN2L248436RES.L8-FT	2	\$6,580	\$1,175	\$2,060	\$700
24 x 84 x 42 high	UN2L248442RES.L8-FT	2	\$6,610	\$1,180	\$2,070	\$700
24 x 96 x 29 high	UN2L249629RES.L8-FT	2	\$6,675	\$1,195	\$2,090	\$700
24 x 96 x 36 high	UN2L249636RES.L8-FT	2	\$6,735	\$1,205	\$2,110	\$700
24 x 96 x 42 high	UN2L249642RES.L8-FT	2	\$6,800	\$1,220	\$2,135	\$700
24 x 120 x 29 high	UN2L2412029RES.L8-FT	2	\$6,860	\$1,230	\$2,155	\$700
24 x 120 x 36 high	UN2L2412036RES.L8-FT	2	\$6,925	\$1,245	\$2,180	\$700
24 x 120 x 42 high	UN2L2412042RES.L8-FT	2	\$6,985	\$1,255	\$2,200	\$700
24 x 144 x 29 high	UN2L2414429RES.L8-FT	3	\$9,685	\$1,795	\$3,145	\$700
24 x 144 x 36 high	UN2L2414436RES.L8-FT	3	\$9,750	\$1,810	\$3,170	\$700
24 x 144 x 42 high	UN2L2414442RES.L8-FT	3	\$9,810	\$1,820	\$3,190	\$700
24 x 168 x 29 high	UN2L2416829RES.L8-FT	3	\$11,060	\$2,070	\$3,625	\$700
24 x 168 x 36 high	UN2L2416836RES.L8-FT	3	\$11,155	\$2,090	\$3,660	\$700
24 x 168 x 42 high	UN2L2416842RES.L8-FT	3	\$11,250	\$2,110	\$3,690	\$700

FOR POWER & A/V OPTIONS  
SEE PAGES 8-20



Power location code includes location on the table and the orientation of the power box.

Use these codes for mounting Cove power into Union panel bases.

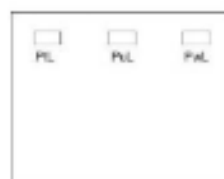

# Union 2.0 Foot Rail

www.hi5furniture.com Questions? 816-774-4050

March 1, 2018



**FINISHES NEEDED:** <http://hi5furniture.com/finishes/>

HPL Color: Hi5 Graded-in laminates or Non-Premium Wilsonart or Formica  
Edge Color: Hi5 Graded-in laminates or Non-Premium Wilsonart or Formica  
Accent Laminate Color, if any.

Panel Base Bracket Color: Any Hi5 standard

Foot Rail Color: Any Hi5 standard

Table Size	Model Code:	Base QTY	Price for: Foot Rail	Upcharge for VDL/Premium Laminate	Upcharge for Color Core	Upcharge for Perimeter Foot Rails Suffix -FTP
30 x 60 x 29 high	UN2L306029RES.L8-FT	2	\$6,050	\$1,070	\$1,870	\$700
30 x 60 x 36 high	UN2L306036RES.L8-FT	2	\$6,110	\$1,080	\$1,895	\$700
30 x 60 x 42 high	UN2L306042RES.L8-FT	2	\$6,360	\$1,130	\$1,980	\$700
30 x 72 x 29 high	UN2L307229RES.L8-FT	2	\$6,485	\$1,155	\$2,025	\$700
30 x 72 x 36 high	UN2L307236RES.L8-FT	2	\$6,550	\$1,170	\$2,045	\$700
30 x 72 x 42 high	UN2L307242RES.L8-FT	2	\$6,610	\$1,180	\$2,070	\$700
30 x 84 x 29 high	UN2L308429RES.L8-FT	2	\$6,675	\$1,195	\$2,090	\$700
30 x 84 x 36 high	UN2L308436RES.L8-FT	2	\$6,735	\$1,205	\$2,110	\$700
30 x 84 x 42 high	UN2L308442RES.L8-FT	2	\$6,800	\$1,220	\$2,135	\$700
30 x 96 x 29 high	UN2L309629RES.L8-FT	2	\$6,860	\$1,230	\$2,155	\$700
30 x 96 x 36 high	UN2L309636RES.L8-FT	2	\$6,925	\$1,245	\$2,180	\$700
30 x 96 x 42 high	UN2L309642RES.L8-FT	2	\$6,985	\$1,255	\$2,200	\$700
30 x 120 x 29 high	UN2L3012029RES.L8-FT	2	\$7,050	\$1,270	\$2,225	\$700
30 x 120 x 36 high	UN2L3012036RES.L8-FT	2	\$7,110	\$1,280	\$2,245	\$700
30 x 120 x 42 high	UN2L3012042RES.L8-FT	2	\$7,175	\$1,295	\$2,265	\$700
30 x 144 x 29 high	UN2L3014429RES.L8-FT	3	\$10,435	\$1,945	\$3,405	\$700
30 x 144 x 36 high	UN2L3014436RES.L8-FT	3	\$10,500	\$1,960	\$3,430	\$700
30 x 144 x 42 high	UN2L3014442RES.L8-FT	3	\$10,560	\$1,970	\$3,450	\$700
30 x 168 x 29 high	UN2L3016829RES.L8-FT	3	\$11,250	\$2,110	\$3,690	\$700
30 x 168 x 36 high	UN2L3016836RES.L8-FT	3	\$11,310	\$2,120	\$3,715	\$700
30 x 168 x 42 high	UN2L3016842RES.L8-FT	3	\$11,375	\$2,135	\$3,735	\$700

FOR POWER & A/V OPTIONS  
SEE PAGES 8-20



Power location code includes location on the table and the orientation of the power box.

Use these codes for mounting Cove power into Union panel bases.



# Union 2.0 Foot Rail

www.hi5furniture.com Questions? 816-774-4050

March 1, 2018



**FINISHES NEEDED:** <http://hi5furniture.com/finishes/>

HPL Color: Hi5 Graded-in laminates or Non-Premium Wilsonart or Formica  
Edge Color: Hi5 Graded-in laminates or Non-Premium Wilsonart or Formica  
Accent Laminate Color, if any.

Panel Base Bracket Color: Any Hi5 standard

Foot Rail Color: Any Hi5 standard

Table Size	Model Code:	Base QTY	Price for: Foot Rail	Upcharge for VDL/Premium Laminate	Upcharge for Color Core	Upcharge for Perimeter Foot Rails Suffix -FTP
36 x 60 x 29 high	UN2L366029RES.L8-FT	2	\$6,235	\$1,105	\$1,935	\$700
36 x 60 x 36 high	UN2L366036RES.L8-FT	2	\$6,300	\$1,120	\$1,960	\$700
36 x 60 x 42 high	UN2L366042RES.L8-FT	2	\$6,550	\$1,170	\$2,045	\$700
36 x 72 x 29 high	UN2L367229RES.L8-FT	2	\$6,675	\$1,195	\$2,090	\$700
36 x 72 x 36 high	UN2L367236RES.L8-FT	2	\$6,735	\$1,205	\$2,110	\$700
36 x 72 x 42 high	UN2L367242RES.L8-FT	2	\$6,800	\$1,220	\$2,135	\$700
36 x 84 x 29 high	UN2L368429RES.L8-FT	2	\$6,860	\$1,230	\$2,155	\$700
36 x 84 x 36 high	UN2L368436RES.L8-FT	2	\$6,925	\$1,245	\$2,180	\$700
36 x 84 x 42 high	UN2L368442RES.L8-FT	2	\$6,985	\$1,255	\$2,200	\$700
36 x 96 x 29 high	UN2L369629RES.L8-FT	2	\$7,050	\$1,270	\$2,225	\$700
36 x 96 x 36 high	UN2L369636RES.L8-FT	2	\$7,110	\$1,280	\$2,245	\$700
36 x 96 x 42 high	UN2L369642RES.L8-FT	2	\$7,175	\$1,295	\$2,265	\$700
36 x 120 x 29 high	UN2L3612029RES.L8-FT	2	\$7,360	\$1,330	\$2,330	\$700
36 x 120 x 36 high	UN2L3612036RES.L8-FT	2	\$7,425	\$1,345	\$2,355	\$700
36 x 120 x 42 high	UN2L3612042RES.L8-FT	2	\$7,485	\$1,355	\$2,375	\$700
36 x 144 x 29 high	UN2L3614429RES.L8-FT	3	\$11,375	\$2,135	\$3,735	\$700
36 x 144 x 36 high	UN2L3614436RES.L8-FT	3	\$11,435	\$2,145	\$3,755	\$700
36 x 144 x 42 high	UN2L3614442RES.L8-FT	3	\$11,500	\$2,160	\$3,780	\$700
36 x 168 x 29 high	UN2L3616829RES.L8-FT	3	\$12,185	\$2,295	\$4,020	\$700
36 x 168 x 36 high	UN2L3616836RES.L8-FT	3	\$12,250	\$2,310	\$4,040	\$700
36 x 168 x 42 high	UN2L3616842RES.L8-FT	3	\$12,310	\$2,320	\$4,065	\$700

FOR POWER & A/V OPTIONS  
SEE PAGES 8-20



Power location code includes location on the table and the orientation of the power box.

Use these codes for mounting Cove power into Union panel bases.



# Union 2.0 Foot Rail

www.hi5furniture.com Questions? 816-774-4050

March 1, 2018



**FINISHES NEEDED:** <http://hi5furniture.com/finishes/>

HPL Color: Hi5 Graded-in laminates or Non-Premium Wilsonart or Formica  
Edge Color: Hi5 Graded-in laminates or Non-Premium Wilsonart or Formica  
Accent Laminate Color, if any.

Panel Base Bracket Color: Any Hi5 standard

Foot Rail Color: Any Hi5 standard

Table Size	Model Code:	Base QTY	Price for: Foot Rail	Upcharge for VDL/Premium Laminate	Upcharge for Color Core	Upcharge for Perimeter Foot Rails Suffix -FTP
42 x 60 x 29 high	UN2L426029RES.L8-FT	2	\$6,550	\$1,170	\$2,045	\$700
42 x 60 x 36 high	UN2L426036RES.L8-FT	2	\$6,610	\$1,180	\$2,070	\$700
42 x 60 x 42 high	UN2L426042RES.L8-FT	2	\$6,860	\$1,230	\$2,155	\$700
42 x 72 x 29 high	UN2L427229RES.L8-FT	2	\$6,985	\$1,255	\$2,200	\$700
42 x 72 x 36 high	UN2L427236RES.L8-FT	2	\$7,050	\$1,270	\$2,225	\$700
42 x 72 x 42 high	UN2L427242RES.L8-FT	2	\$7,110	\$1,280	\$2,245	\$700
42 x 84 x 29 high	UN2L428429RES.L8-FT	2	\$7,485	\$1,355	\$2,375	\$700
42 x 84 x 36 high	UN2L428436RES.L8-FT	2	\$7,550	\$1,370	\$2,400	\$700
42 x 84 x 42 high	UN2L428442RES.L8-FT	2	\$7,610	\$1,380	\$2,420	\$700
42 x 96 x 29 high	UN2L429629RES.L8-FT	2	\$7,675	\$1,395	\$2,440	\$700
42 x 96 x 36 high	UN2L429636RES.L8-FT	2	\$7,735	\$1,405	\$2,460	\$700
42 x 96 x 42 high	UN2L429642RES.L8-FT	2	\$7,800	\$1,420	\$2,485	\$700
42 x 120 x 29 high	UN2L4212029RES.L8-FT	2	\$8,300	\$1,520	\$2,660	\$700
42 x 120 x 36 high	UN2L4212036RES.L8-FT	2	\$8,360	\$1,530	\$2,680	\$700
42 x 120 x 42 high	UN2L4212042RES.L8-FT	2	\$8,425	\$1,545	\$2,705	\$700
42 x 144 x 29 high	UN2L4214429RES.L8-FT	3	\$12,625	\$2,385	\$4,175	\$700
42 x 144 x 36 high	UN2L4214436RES.L8-FT	3	\$12,685	\$2,395	\$4,195	\$700
42 x 144 x 42 high	UN2L4214442RES.L8-FT	3	\$12,750	\$2,410	\$4,220	\$700
42 x 168 x 29 high	UN2L4216829RES.L8-FT	3	\$13,435	\$2,545	\$4,455	\$700
42 x 168 x 36 high	UN2L4216836RES.L8-FT	3	\$13,500	\$2,560	\$4,480	\$700
42 x 168 x 42 high	UN2L4216842RES.L8-FT	3	\$13,560	\$2,570	\$4,500	\$700

FOR POWER & A/V OPTIONS  
SEE PAGES 8-20



Power location code includes location on the table and the orientation of the power box.

Use these codes for mounting Cove power into Union panel bases.

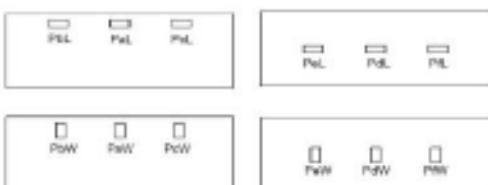



# Union 2.0 Foot Rail

www.hi5furniture.com Questions? 816-774-4050

March 1, 2018



**FINISHES NEEDED:** <http://hi5furniture.com/finishes/>

HPL Color: Hi5 Graded-in laminates or Non-Premium Wilsonart or Formica  
Edge Color: Hi5 Graded-in laminates or Non-Premium Wilsonart or Formica  
Accent Laminate Color, if any.

Panel Base Bracket Color: Any Hi5 standard

Foot Rail Color: Any Hi5 standard

Table Size	Model Code:	Base QTY	Price for: Foot Rail	Upcharge for VDL/Premium Laminate	Upcharge for Color Core	Upcharge for Perimeter Foot Rails Suffix -FTP
48 x 60 x 29 high	UN2L486029RES.L8-FT	2	\$6,860	\$1,230	\$2,155	\$700
48 x 60 x 36 high	UN2L486036RES.L8-FT	2	\$6,925	\$1,245	\$2,180	\$700
48 x 60 x 42 high	UN2L486042RES.L8-FT	2	\$7,175	\$1,295	\$2,265	\$700
48 x 72 x 29 high	UN2L487229RES.L8-FT	2	\$7,300	\$1,320	\$2,310	\$700
48 x 72 x 36 high	UN2L487236RES.L8-FT	2	\$7,360	\$1,330	\$2,330	\$700
48 x 72 x 42 high	UN2L487242RES.L8-FT	2	\$7,425	\$1,345	\$2,355	\$700
48 x 84 x 29 high	UN2L488429RES.L8-FT	2	\$8,110	\$1,480	\$2,595	\$700
48 x 84 x 36 high	UN2L488436RES.L8-FT	2	\$8,175	\$1,495	\$2,615	\$700
48 x 84 x 42 high	UN2L488442RES.L8-FT	2	\$8,235	\$1,505	\$2,635	\$700
48 x 96 x 29 high	UN2L489629RES.L8-FT	2	\$8,300	\$1,520	\$2,660	\$700
48 x 96 x 36 high	UN2L489636RES.L8-FT	2	\$8,360	\$1,530	\$2,680	\$700
48 x 96 x 42 high	UN2L489642RES.L8-FT	2	\$8,425	\$1,545	\$2,705	\$700
48 x 120 x 29 high	UN2L4812029RES.L8-FT	2	\$9,235	\$1,705	\$2,985	\$700
48 x 120 x 36 high	UN2L4812036RES.L8-FT	2	\$9,300	\$1,720	\$3,010	\$700
48 x 120 x 42 high	UN2L4812042RES.L8-FT	2	\$9,360	\$1,730	\$3,030	\$700
48 x 144 x 29 high	UN2L4814429RES.L8-FT	3	\$15,110	\$2,880	\$5,045	\$700
48 x 144 x 36 high	UN2L4814436RES.L8-FT	3	\$15,180	\$2,895	\$5,070	\$700
48 x 144 x 42 high	UN2L4814442RES.L8-FT	3	\$15,250	\$2,910	\$5,095	\$700
48 x 168 x 29 high	UN2L4816829RES.L8-FT	3	\$16,020	\$3,065	\$5,360	\$700
48 x 168 x 36 high	UN2L4816836RES.L8-FT	3	\$16,090	\$3,080	\$5,385	\$700
48 x 168 x 42 high	UN2L4816842RES.L8-FT	3	\$16,160	\$3,090	\$5,410	\$700

FOR POWER & A/V OPTIONS  
SEE PAGES 8-20



Power location code includes location on the table and the orientation of the power box.

Use these codes for mounting Cove power into Union panel bases.

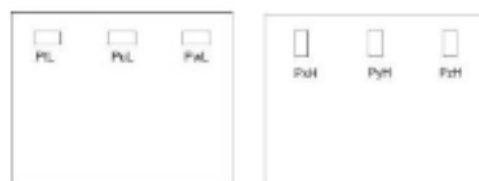
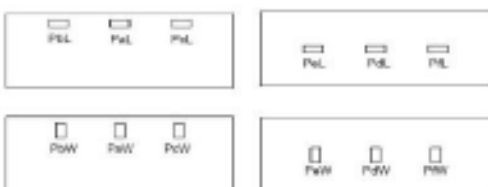

# Union 2.0 Foot Rail

www.hi5furniture.com Questions? 816-774-4050

March 1, 2018



**FINISHES NEEDED:** <http://hi5furniture.com/finishes/>

HPL Color: Hi5 Graded-in laminates or Non-Premium Wilsonart or Formica  
Edge Color: Hi5 Graded-in laminates or Non-Premium Wilsonart or Formica  
Accent Laminate Color, if any.

Panel Base Bracket Color: Any Hi5 standard

Foot Rail Color: Any Hi5 standard

Table Size	Model Code:	Base QTY	Price for: Foot Rail	Upcharge for VDL/Premium Laminate	Upcharge for Color Core	Upcharge for Perimeter Foot Rails Suffix -FTP
60 x 60 x 29 high	UN2L606029SQS.L8-FT	2	\$7,795	\$1,420	N/A	\$700
60 x 60 x 36 high	UN2L606036SQS.L8-FT	2	\$7,865	\$1,435	N/A	\$700
60 x 60 x 42 high	UN2L606042SQS.L8-FT	2	\$8,145	\$1,490	N/A	\$700
60 x 72 x 29 high	UN2L607229RES.L8-FT	2	\$8,285	\$1,515	N/A	\$700
60 x 72 x 36 high	UN2L607236RES.L8-FT	2	\$8,355	\$1,530	N/A	\$700
60 x 72 x 42 high	UN2L607242RES.L8-FT	2	\$8,425	\$1,545	N/A	\$700
60 x 84 x 29 high	UN2L608429RES.L8-FT	2	\$9,545	\$1,770	N/A	\$700
60 x 84 x 36 high	UN2L608436RES.L8-FT	2	\$9,615	\$1,785	N/A	\$700
60 x 84 x 42 high	UN2L608442RES.L8-FT	2	\$9,685	\$1,795	N/A	\$700
60 x 96 x 29 high	UN2L609629RES.L8-FT	2	\$9,755	\$1,810	N/A	\$700
60 x 96 x 36 high	UN2L609636RES.L8-FT	2	\$9,825	\$1,825	N/A	\$700
60 x 96 x 42 high	UN2L609642RES.L8-FT	2	\$9,895	\$1,840	N/A	\$700
60 x 120 x 29 high	UN2L6012029RES.L8-FT	2	\$11,155	\$2,090	N/A	\$700
60 x 120 x 36 high	UN2L6012036RES.L8-FT	2	\$11,225	\$2,105	N/A	\$700
60 x 120 x 42 high	UN2L6012042RES.L8-FT	2	\$11,295	\$2,120	N/A	\$700
60 x 144 x 29 high	UN2L6014429RES.L8-FT	3	\$16,510	\$3,160	N/A	\$700
60 x 144 x 36 high	UN2L6014436RES.L8-FT	3	\$16,580	\$3,175	N/A	\$700
60 x 144 x 42 high	UN2L6014442RES.L8-FT	3	\$16,650	\$3,190	N/A	\$700
60 x 168 x 29 high	UN2L6016829RES.L8-FT	3	\$17,420	\$3,345	N/A	\$700
60 x 168 x 36 high	UN2L6016836RES.L8-FT	3	\$17,490	\$3,360	N/A	\$700
60 x 168 x 42 high	UN2L6016842RES.L8-FT	3	\$17,560	\$3,370	N/A	\$700

FOR POWER & A/V OPTIONS  
SEE PAGES 8-20



Power location code includes location on the table and the orientation of the power box.

Use these codes for mounting Cove power into Union panel bases.

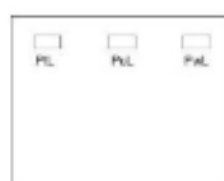
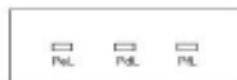

# Union 2.0 Full Modesty Panel

www.hi5furniture.com Questions? 816-774-4050

March 1, 2018



**FINISHES NEEDED:** <http://hi5furniture.com/finishes/>

HPL Color: Hi5 Graded-in laminates or Non-Premium Wilsonart or Formica  
 Edge Color: Hi5 Graded-in laminates or Non-Premium Wilsonart or Formica  
 Modesty Panel Color: Hi5 Graded-in laminates or Non-Premium Wilsonart or Formica  
 Panel Base Bracket Color: Any Hi5 standard  
 Modesty Panel Corner Bracket Color:

Table Size	Model Code:	Base QTY	Price for: Full Modesty	Upcharge for VDL/Premium Laminate	Upcharge for Color Core
24 x 60 x 29 high	UN2 L 246029RES.L8-FML	2	\$6,690	\$1,030	\$1,805
24 x 60 x 36 high	UN2 L 246036RES.L8-FML	2	\$6,815	\$1,055	\$1,850
24 x 60 x 42 high	UN2 L 246042RES.L8-FML	2	\$6,970	\$1,090	\$1,905
24 x 72 x 29 high	UN2 L 247229RES.L8-FML	2	\$7,130	\$1,120	\$1,960
24 x 72 x 36 high	UN2 L 247236RES.L8-FML	2	\$7,190	\$1,130	\$1,980
24 x 72 x 42 high	UN2 L 247242RES.L8-FML	2	\$7,315	\$1,155	\$2,025
24 x 84 x 29 high	UN2 L 248429RES.L8-FML	2	\$7,650	\$1,170	\$2,045
24 x 84 x 36 high	UN2 L 248436RES.L8-FML	2	\$7,680	\$1,175	\$2,060
24 x 84 x 42 high	UN2 L 248442RES.L8-FML	2	\$7,710	\$1,180	\$2,070
24 x 96 x 29 high	UN2 L 249629RES.L8-FML	2	\$7,775	\$1,195	\$2,090
24 x 96 x 36 high	UN2 L 249636RES.L8-FML	2	\$7,835	\$1,205	\$2,110
24 x 96 x 42 high	UN2 L 249642RES.L8-FML	2	\$7,900	\$1,220	\$2,135
24 x 120 x 29 high	UN2 L 2412029RES.L8-FML	2	\$8,860	\$1,230	\$2,155
24 x 120 x 36 high	UN2 L 2412036RES.L8-FML	2	\$8,925	\$1,245	\$2,180
24 x 120 x 42 high	UN2 L 2412042RES.L8-FML	2	\$8,985	\$1,255	\$2,200
24 x 144 x 29 high	UN2 L 2414429RES.L8-FML	3	\$12,855	\$1,795	\$3,145
24 x 144 x 36 high	UN2 L 2414436RES.L8-FML	3	\$12,920	\$1,810	\$3,170
24 x 144 x 42 high	UN2 L 2414442RES.L8-FML	3	\$12,980	\$1,820	\$3,190
24 x 168 x 29 high	UN2 L 2416829RES.L8-FML	3	\$14,230	\$2,070	\$3,625
24 x 168 x 36 high	UN2 L 2416836RES.L8-FML	3	\$14,325	\$2,090	\$3,660
24 x 168 x 42 high	UN2 L 2416842RES.L8-FML	3	\$14,420	\$2,110	\$3,690

**FOR POWER & A/V OPTIONS**  
SEE PAGES 8-20



Power location code includes location on the table and the orientation of the power box.

Use these codes for mounting Cove power into Union panel bases.



# Union 2.0 Full Modesty Panel

www.hi5furniture.com Questions? 816-774-4050

March 1, 2018



**FINISHES NEEDED:** <http://hi5furniture.com/finishes/>

HPL Color: Hi5 Graded-in laminates or Non-Premium Wilsonart or Formica  
 Edge Color: Hi5 Graded-in laminates or Non-Premium Wilsonart or Formica  
 Modesty Panel Color: Hi5 Graded-in laminates or Non-Premium Wilsonart or Formica  
 Panel Base Bracket Color: Any Hi5 standard  
 Modesty Panel Corner Bracket Color:

Table Size	Model Code:	Base QTY	Price for: Full Modesty	Upcharge for VDL/Premium Laminate	Upcharge for Color Core
30 x 60 x 29 high	UN2 L 306029RES.L8-FML	2	\$6,880	\$1,070	\$1,870
30 x 60 x 36 high	UN2 L 306036RES.L8-FML	2	\$6,940	\$1,080	\$1,895
30 x 60 x 42 high	UN2 L 306042RES.L8-FML	2	\$7,190	\$1,130	\$1,980
30 x 72 x 29 high	UN2 L 307229RES.L8-FML	2	\$7,315	\$1,155	\$2,025
30 x 72 x 36 high	UN2 L 307236RES.L8-FML	2	\$7,380	\$1,170	\$2,045
30 x 72 x 42 high	UN2 L 307242RES.L8-FML	2	\$7,440	\$1,180	\$2,070
30 x 84 x 29 high	UN2 L 308429RES.L8-FML	2	\$7,775	\$1,195	\$2,090
30 x 84 x 36 high	UN2 L 308436RES.L8-FML	2	\$7,835	\$1,205	\$2,110
30 x 84 x 42 high	UN2 L 308442RES.L8-FML	2	\$7,900	\$1,220	\$2,135
30 x 96 x 29 high	UN2 L 309629RES.L8-FML	2	\$7,960	\$1,230	\$2,155
30 x 96 x 36 high	UN2 L 309636RES.L8-FML	2	\$8,025	\$1,245	\$2,180
30 x 96 x 42 high	UN2 L 309642RES.L8-FML	2	\$8,085	\$1,255	\$2,200
30 x 120 x 29 high	UN2 L 3012029RES.L8-FML	2	\$9,050	\$1,270	\$2,225
30 x 120 x 36 high	UN2 L 3012036RES.L8-FML	2	\$9,110	\$1,280	\$2,245
30 x 120 x 42 high	UN2 L 3012042RES.L8-FML	2	\$9,175	\$1,295	\$2,265
30 x 144 x 29 high	UN2 L 3014429RES.L8-FML	3	\$13,605	\$1,945	\$3,405
30 x 144 x 36 high	UN2 L 3014436RES.L8-FML	3	\$13,670	\$1,960	\$3,430
30 x 144 x 42 high	UN2 L 3014442RES.L8-FML	3	\$13,730	\$1,970	\$3,450
30 x 168 x 29 high	UN2 L 3016829RES.L8-FML	3	\$14,420	\$2,110	\$3,690
30 x 168 x 36 high	UN2 L 3016836RES.L8-FML	3	\$14,480	\$2,120	\$3,715
30 x 168 x 42 high	UN2 L 3016842RES.L8-FML	3	\$14,545	\$2,135	\$3,735

**FOR POWER & A/V OPTIONS**  
SEE PAGES 8-20



Power location code includes location on the table and the orientation of the power box.

Use these codes for mounting Cove power into Union panel bases.



# Union 2.0 Full Modesty Panel

www.hi5furniture.com Questions? 816-774-4050

March 1, 2018



**FINISHES NEEDED:** <http://hi5furniture.com/finishes/>

HPL Color: Hi5 Graded-in laminates or Non-Premium Wilsonart or Formica  
 Edge Color: Hi5 Graded-in laminates or Non-Premium Wilsonart or Formica  
 Modesty Panel Color: Hi5 Graded-in laminates or Non-Premium Wilsonart or Formica  
 Panel Base Bracket Color: Any Hi5 standard  
 Modesty Panel Corner Bracket Color:

Table Size	Model Code:	Base QTY	Price for: Full Modesty	Upcharge for VDL/Premium Laminate	Upcharge for Color Core
36 x 60 x 29 high	UN2 L 366029RES.L8-FML	2	\$7,065	\$1,105	\$1,935
36 x 60 x 36 high	UN2 L 366036RES.L8-FML	2	\$7,130	\$1,120	\$1,960
36 x 60 x 42 high	UN2 L 366042RES.L8-FML	2	\$7,380	\$1,170	\$2,045
36 x 72 x 29 high	UN2 L 367229RES.L8-FML	2	\$7,505	\$1,195	\$2,090
36 x 72 x 36 high	UN2 L 367236RES.L8-FML	2	\$7,565	\$1,205	\$2,110
36 x 72 x 42 high	UN2 L 367242RES.L8-FML	2	\$7,630	\$1,220	\$2,135
36 x 84 x 29 high	UN2 L 368429RES.L8-FML	2	\$7,960	\$1,230	\$2,155
36 x 84 x 36 high	UN2 L 368436RES.L8-FML	2	\$8,025	\$1,245	\$2,180
36 x 84 x 42 high	UN2 L 368442RES.L8-FML	2	\$8,085	\$1,255	\$2,200
36 x 96 x 29 high	UN2 L 369629RES.L8-FML	2	\$8,150	\$1,270	\$2,225
36 x 96 x 36 high	UN2 L 369636RES.L8-FML	2	\$8,210	\$1,280	\$2,245
36 x 96 x 42 high	UN2 L 369642RES.L8-FML	2	\$8,275	\$1,295	\$2,265
36 x 120 x 29 high	UN2 L 3612029RES.L8-FML	2	\$9,360	\$1,330	\$2,330
36 x 120 x 36 high	UN2 L 3612036RES.L8-FML	2	\$9,425	\$1,345	\$2,355
36 x 120 x 42 high	UN2 L 3612042RES.L8-FML	2	\$9,485	\$1,355	\$2,375
36 x 144 x 29 high	UN2 L 3614429RES.L8-FML	3	\$14,545	\$2,135	\$3,735
36 x 144 x 36 high	UN2 L 3614436RES.L8-FML	3	\$14,605	\$2,145	\$3,755
36 x 144 x 42 high	UN2 L 3614442RES.L8-FML	3	\$14,670	\$2,160	\$3,780
36 x 168 x 29 high	UN2 L 3616829RES.L8-FML	3	\$15,355	\$2,295	\$4,020
36 x 168 x 36 high	UN2 L 3616836RES.L8-FML	3	\$15,420	\$2,310	\$4,040
36 x 168 x 42 high	UN2 L 3616842RES.L8-FML	3	\$15,480	\$2,320	\$4,065

**FOR POWER & A/V OPTIONS**  
SEE PAGES 8-20



Power location code includes location on the table and the orientation of the power box.

Use these codes for mounting Cove power into Union panel bases.



# Union 2.0 Full Modesty Panel

www.hi5furniture.com Questions? 816-774-4050

March 1, 2018



**FINISHES NEEDED:** <http://hi5furniture.com/finishes/>

HPL Color: Hi5 Graded-in laminates or Non-Premium Wilsonart or Formica  
 Edge Color: Hi5 Graded-in laminates or Non-Premium Wilsonart or Formica  
 Modesty Panel Color: Hi5 Graded-in laminates or Non-Premium Wilsonart or Formica  
 Panel Base Bracket Color: Any Hi5 standard  
 Modesty Panel Corner Bracket Color:

Table Size	Model Code:	Base QTY	Price for: Full Modesty	Upcharge for VDL/Premium Laminate	Upcharge for Color Core
42 x 60 x 29 high	UN2 L 426029RES.L8-FML	2	\$7,380	\$1,170	\$2,045
42 x 60 x 36 high	UN2 L 426036RES.L8-FML	2	\$7,440	\$1,180	\$2,070
42 x 60 x 42 high	UN2 L 426042RES.L8-FML	2	\$7,690	\$1,230	\$2,155
42 x 72 x 29 high	UN2 L 427229RES.L8-FML	2	\$7,815	\$1,255	\$2,200
42 x 72 x 36 high	UN2 L 427236RES.L8-FML	2	\$7,880	\$1,270	\$2,225
42 x 72 x 42 high	UN2 L 427242RES.L8-FML	2	\$7,940	\$1,280	\$2,245
42 x 84 x 29 high	UN2 L 428429RES.L8-FML	2	\$8,585	\$1,355	\$2,375
42 x 84 x 36 high	UN2 L 428436RES.L8-FML	2	\$8,650	\$1,370	\$2,400
42 x 84 x 42 high	UN2 L 428442RES.L8-FML	2	\$8,710	\$1,380	\$2,420
42 x 96 x 29 high	UN2 L 429629RES.L8-FML	2	\$8,775	\$1,395	\$2,440
42 x 96 x 36 high	UN2 L 429636RES.L8-FML	2	\$8,835	\$1,405	\$2,460
42 x 96 x 42 high	UN2 L 429642RES.L8-FML	2	\$8,900	\$1,420	\$2,485
42 x 120 x 29 high	UN2 L 4212029RES.L8-FML	2	\$10,300	\$1,520	\$2,660
42 x 120 x 36 high	UN2 L 4212036RES.L8-FML	2	\$10,360	\$1,530	\$2,680
42 x 120 x 42 high	UN2 L 4212042RES.L8-FML	2	\$10,425	\$1,545	\$2,705
42 x 144 x 29 high	UN2 L 4214429RES.L8-FML	3	\$15,795	\$2,385	\$4,175
42 x 144 x 36 high	UN2 L 4214436RES.L8-FML	3	\$15,855	\$2,395	\$4,195
42 x 144 x 42 high	UN2 L 4214442RES.L8-FML	3	\$15,920	\$2,410	\$4,220
42 x 168 x 29 high	UN2 L 4216829RES.L8-FML	3	\$16,605	\$2,545	\$4,455
42 x 168 x 36 high	UN2 L 4216836RES.L8-FML	3	\$16,670	\$2,560	\$4,480
42 x 168 x 42 high	UN2 L 4216842RES.L8-FML	3	\$16,730	\$2,570	\$4,500

**FOR POWER & A/V OPTIONS**  
SEE PAGES 8-20



Power location code includes location on the table and the orientation of the power box.

Use these codes for mounting Cove power into Union panel bases.



# Union 2.0 Full Modesty Panel

www.hi5furniture.com Questions? 816-774-4050

March 1, 2018



**FINISHES NEEDED:** <http://hi5furniture.com/finishes/>

HPL Color: Hi5 Graded-in laminates or Non-Premium Wilsonart or Formica  
 Edge Color: Hi5 Graded-in laminates or Non-Premium Wilsonart or Formica  
 Modesty Panel Color: Hi5 Graded-in laminates or Non-Premium Wilsonart or Formica  
 Panel Base Bracket Color: Any Hi5 standard  
 Modesty Panel Corner Bracket Color:

Table Size	Model Code:	Base QTY	Price for: Full Modesty	Upcharge for VDL/Premium Laminate	Upcharge for Color Core
48 x 60 x 29 high	UN2L486029RES.L8-FML	2	\$7,690	\$1,230	\$2,155
48 x 60 x 36 high	UN2L486036RES.L8-FML	2	\$7,755	\$1,245	\$2,180
48 x 60 x 42 high	UN2L486042RES.L8-FML	2	\$8,005	\$1,295	\$2,265
48 x 72 x 29 high	UN2L487229RES.L8-FML	2	\$8,130	\$1,320	\$2,310
48 x 72 x 36 high	UN2L487236RES.L8-FML	2	\$8,190	\$1,330	\$2,330
48 x 72 x 42 high	UN2L487242RES.L8-FML	2	\$8,255	\$1,345	\$2,355
48 x 84 x 29 high	UN2L488429RES.L8-FML	2	\$9,210	\$1,480	\$2,595
48 x 84 x 36 high	UN2L488436RES.L8-FML	2	\$9,275	\$1,495	\$2,615
48 x 84 x 42 high	UN2L488442RES.L8-FML	2	\$9,335	\$1,505	\$2,635
48 x 96 x 29 high	UN2L489629RES.L8-FML	2	\$9,400	\$1,520	\$2,660
48 x 96 x 36 high	UN2L489636RES.L8-FML	2	\$9,460	\$1,530	\$2,680
48 x 96 x 42 high	UN2L489642RES.L8-FML	2	\$9,525	\$1,545	\$2,705
48 x 120 x 29 high	UN2L4812029RES.L8-FML	2	\$11,235	\$1,705	\$2,985
48 x 120 x 36 high	UN2L4812036RES.L8-FML	2	\$11,300	\$1,720	\$3,010
48 x 120 x 42 high	UN2L4812042RES.L8-FML	2	\$11,360	\$1,730	\$3,030
48 x 144 x 29 high	UN2L4814429RES.L8-FML	3	\$18,280	\$2,880	\$5,045
48 x 144 x 36 high	UN2L4814436RES.L8-FML	3	\$18,350	\$2,895	\$5,070
48 x 144 x 42 high	UN2L4814442RES.L8-FML	3	\$18,420	\$2,910	\$5,095
48 x 168 x 29 high	UN2L4816829RES.L8-FML	3	\$19,190	\$3,065	\$5,360
48 x 168 x 36 high	UN2L4816836RES.L8-FML	3	\$19,260	\$3,080	\$5,385
48 x 168 x 42 high	UN2L4816842RES.L8-FML	3	\$19,330	\$3,090	\$5,410

FOR POWER & A/V OPTIONS  
SEE PAGES 8-20



Power location code includes location on the table and the orientation of the power box.

Use these codes for mounting Cove power into Union panel bases.



# Union 2.0 Full Modesty Panel

www.hi5furniture.com Questions? 816-774-4050  
March 1, 2018



**FINISHES NEEDED:** <http://hi5furniture.com/finishes/>

HPL Color: Hi5 Graded-in laminates or Non-Premium Wilsonart or Formica  
Edge Color: Hi5 Graded-in laminates or Non-Premium Wilsonart or Formica  
Modesty Panel Color: Hi5 Graded-in laminates or Non-Premium Wilsonart or Formica  
Panel Base Bracket Color: Any Hi5 standard  
Modesty Panel Corner Bracket Color:

Table Size	Model Code:	Base QTY	Price for: Full Modesty	Upcharge for VDL/Premium Laminate	Upcharge for Color Core
60 x 60 x 29 high	UN2 L 606029SQS.L8-FML	2	\$8,625	\$1,420	N/A
60 x 60 x 36 high	UN2 L 606036SQS.L8-FML	2	\$8,695	\$1,435	N/A
60 x 60 x 42 high	UN2 L 606042SQS.L8-FML	2	\$8,975	\$1,490	N/A
60 x 72 x 29 high	UN2 L 607229RES.L8-FML	2	\$9,115	\$1,515	N/A
60 x 72 x 36 high	UN2 L 607236RES.L8-FML	2	\$9,185	\$1,530	N/A
60 x 72 x 42 high	UN2 L 607242RES.L8-FML	2	\$9,255	\$1,545	N/A
60 x 84 x 29 high	UN2 L 608429RES.L8-FML	2	\$10,645	\$1,770	N/A
60 x 84 x 36 high	UN2 L 608436RES.L8-FML	2	\$10,715	\$1,785	N/A
60 x 84 x 42 high	UN2 L 608442RES.L8-FML	2	\$10,785	\$1,795	N/A
60 x 96 x 29 high	UN2 L 609629RES.L8-FML	2	\$10,855	\$1,810	N/A
60 x 96 x 36 high	UN2 L 609636RES.L8-FML	2	\$10,925	\$1,825	N/A
60 x 96 x 42 high	UN2 L 609642RES.L8-FML	2	\$10,995	\$1,840	N/A
60 x 120 x 29 high	UN2 L 6012029RES.L8-FML	2	\$13,155	\$2,090	N/A
60 x 120 x 36 high	UN2 L 6012036RES.L8-FML	2	\$13,225	\$2,105	N/A
60 x 120 x 42 high	UN2 L 6012042RES.L8-FML	2	\$13,295	\$2,120	N/A
60 x 144 x 29 high	UN2 L 6014429RES.L8-FML	3	\$19,680	\$3,160	N/A
60 x 144 x 36 high	UN2 L 6014436RES.L8-FML	3	\$19,750	\$3,175	N/A
60 x 144 x 42 high	UN2 L 6014442RES.L8-FML	3	\$19,820	\$3,190	N/A
60 x 168 x 29 high	UN2 L 6016829RES.L8-FML	3	\$20,590	\$3,345	N/A
60 x 168 x 36 high	UN2 L 6016836RES.L8-FML	3	\$20,660	\$3,360	N/A
60 x 168 x 42 high	UN2 L 6016842RES.L8-FML	3	\$20,730	\$3,370	N/A

**FOR POWER & A/V OPTIONS**  
SEE PAGES 8-20



Power location code includes location on the table and the orientation of the power box.

Use these codes for mounting Cove power into Union panel bases.

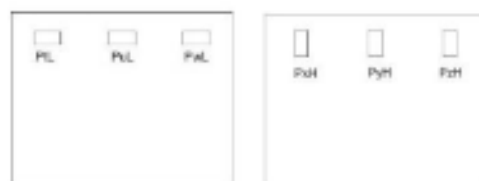



# Union 2.0 Half Modesty Panel

www.hi5furniture.com Questions? 816-774-4050

March 1, 2018



**FINISHES NEEDED:** <http://hi5furniture.com/finishes/>

HPL Color: Hi5 Graded-in laminates or Non-Premium Wilsonart or Formica  
 Edge Color: Hi5 Graded-in laminates or Non-Premium Wilsonart or Formica  
 Modesty Panel Color: Hi5 Graded-in laminates or Non-Premium Wilsonart or Formica  
 Panel Base Bracket Color: Any Hi5 standard  
 Modesty Panel Corner Bracket Color:

Table Size	Model Code:	Base QTY	Price for: Half Modesty	Upcharge for VDL/Premium Laminate	Upcharge for Color Core
24 x 60 x 29 high	UN2 L 246029RES.L8-HML	2	\$6,510	\$1,030	\$1,805
24 x 60 x 36 high	UN2 L 246036RES.L8-HML	2	\$6,635	\$1,055	\$1,850
24 x 60 x 42 high	UN2 L 246042RES.L8-HML	2	\$6,790	\$1,090	\$1,905
24 x 72 x 29 high	UN2 L 247229RES.L8-HML	2	\$6,950	\$1,120	\$1,960
24 x 72 x 36 high	UN2 L 247236RES.L8-HML	2	\$7,010	\$1,130	\$1,980
24 x 72 x 42 high	UN2 L 247242RES.L8-HML	2	\$7,135	\$1,155	\$2,025
24 x 84 x 29 high	UN2 L 248429RES.L8-HML	2	\$7,470	\$1,170	\$2,045
24 x 84 x 36 high	UN2 L 248436RES.L8-HML	2	\$7,500	\$1,175	\$2,060
24 x 84 x 42 high	UN2 L 248442RES.L8-HML	2	\$7,530	\$1,180	\$2,070
24 x 96 x 29 high	UN2 L 249629RES.L8-HML	2	\$7,595	\$1,195	\$2,090
24 x 96 x 36 high	UN2 L 249636RES.L8-HML	2	\$7,655	\$1,205	\$2,110
24 x 96 x 42 high	UN2 L 249642RES.L8-HML	2	\$7,720	\$1,220	\$2,135
24 x 120 x 29 high	UN2 L 2412029RES.L8-HML	2	\$8,680	\$1,230	\$2,155
24 x 120 x 36 high	UN2 L 2412036RES.L8-HML	2	\$8,745	\$1,245	\$2,180
24 x 120 x 42 high	UN2 L 2412042RES.L8-HML	2	\$8,805	\$1,255	\$2,200
24 x 144 x 29 high	UN2 L 2414429RES.L8-HML	3	\$12,585	\$1,795	\$3,145
24 x 144 x 36 high	UN2 L 2414436RES.L8-HML	3	\$12,650	\$1,810	\$3,170
24 x 144 x 42 high	UN2 L 2414442RES.L8-HML	3	\$12,710	\$1,820	\$3,190
24 x 168 x 29 high	UN2 L 2416829RES.L8-HML	3	\$13,960	\$2,070	\$3,625
24 x 168 x 36 high	UN2 L 2416836RES.L8-HML	3	\$14,055	\$2,090	\$3,660
24 x 168 x 42 high	UN2 L 2416842RES.L8-HML	3	\$14,150	\$2,110	\$3,690

**FOR POWER & A/V OPTIONS**  
SEE PAGES 8-20



Power location code includes location on the table and the orientation of the power box.

Use these codes for mounting Cove power into Union panel bases.



# Union 2.0 Half Modesty Panel

www.hi5furniture.com Questions? 816-774-4050

March 1, 2018



**FINISHES NEEDED:** <http://hi5furniture.com/finishes/>

HPL Color: Hi5 Graded-in laminates or Non-Premium Wilsonart or Formica

Edge Color: Hi5 Graded-in laminates or Non-Premium Wilsonart or Formica

Modesty Panel Color: Hi5 Graded-in laminates or Non-Premium Wilsonart or Formica

Panel Base Bracket Color: Any Hi5 standard

Modesty Panel Corner Bracket Color:

Table Size	Model Code:	Base QTY	Price for: Half Modesty	Upcharge for VDL/Premium Laminate	Upcharge for Color Core
30 x 60 x 29 high	UN2 L 306029RES.L8-HML	2	\$6,700	\$1,070	\$1,870
30 x 60 x 36 high	UN2 L 306036RES.L8-HML	2	\$6,760	\$1,080	\$1,895
30 x 60 x 42 high	UN2 L 306042RES.L8-HML	2	\$7,010	\$1,130	\$1,980
30 x 72 x 29 high	UN2 L 307229RES.L8-HML	2	\$7,135	\$1,155	\$2,025
30 x 72 x 36 high	UN2 L 307236RES.L8-HML	2	\$7,200	\$1,170	\$2,045
30 x 72 x 42 high	UN2 L 307242RES.L8-HML	2	\$7,260	\$1,180	\$2,070
30 x 84 x 29 high	UN2 L 308429RES.L8-HML	2	\$7,595	\$1,195	\$2,090
30 x 84 x 36 high	UN2 L 308436RES.L8-HML	2	\$7,655	\$1,205	\$2,110
30 x 84 x 42 high	UN2 L 308442RES.L8-HML	2	\$7,720	\$1,220	\$2,135
30 x 96 x 29 high	UN2 L 309629RES.L8-HML	2	\$7,780	\$1,230	\$2,155
30 x 96 x 36 high	UN2 L 309636RES.L8-HML	2	\$7,845	\$1,245	\$2,180
30 x 96 x 42 high	UN2 L 309642RES.L8-HML	2	\$7,905	\$1,255	\$2,200
30 x 120 x 29 high	UN2 L 3012029RES.L8-HML	2	\$8,870	\$1,270	\$2,225
30 x 120 x 36 high	UN2 L 3012036RES.L8-HML	2	\$8,930	\$1,280	\$2,245
30 x 120 x 42 high	UN2 L 3012042RES.L8-HML	2	\$8,995	\$1,295	\$2,265
30 x 144 x 29 high	UN2 L 3014429RES.L8-HML	3	\$13,335	\$1,945	\$3,405
30 x 144 x 36 high	UN2 L 3014436RES.L8-HML	3	\$13,400	\$1,960	\$3,430
30 x 144 x 42 high	UN2 L 3014442RES.L8-HML	3	\$13,460	\$1,970	\$3,450
30 x 168 x 29 high	UN2 L 3016829RES.L8-HML	3	\$14,150	\$2,110	\$3,690
30 x 168 x 36 high	UN2 L 3016836RES.L8-HML	3	\$14,210	\$2,120	\$3,715
30 x 168 x 42 high	UN2 L 3016842RES.L8-HML	3	\$14,275	\$2,135	\$3,735

FOR POWER & A/V OPTIONS  
SEE PAGES 8-20



Power location code includes location on the table and the orientation of the power box.

Use these codes for mounting Cove power into Union panel bases.



# Union 2.0 Half Modesty Panel

www.hi5furniture.com Questions? 816-774-4050

March 1, 2018



**FINISHES NEEDED:** <http://hi5furniture.com/finishes/>

HPL Color: Hi5 Graded-in laminates or Non-Premium Wilsonart or Formica

Edge Color: Hi5 Graded-in laminates or Non-Premium Wilsonart or Formica

Modesty Panel Color: Hi5 Graded-in laminates or Non-Premium Wilsonart or Formica

Panel Base Bracket Color: Any Hi5 standard

Modesty Panel Corner Bracket Color:

Table Size	Model Code:	Base QTY	Price for: Half Modesty	Upcharge for VDL/Premium Laminate	Upcharge for Color Core
36 x 60 x 29 high	UN2 L 366029RES.L8-HML	2	\$6,885	\$1,105	\$1,935
36 x 60 x 36 high	UN2 L 366036RES.L8-HML	2	\$6,950	\$1,120	\$1,960
36 x 60 x 42 high	UN2 L 366042RES.L8-HML	2	\$7,200	\$1,170	\$2,045
36 x 72 x 29 high	UN2 L 367229RES.L8-HML	2	\$7,325	\$1,195	\$2,090
36 x 72 x 36 high	UN2 L 367236RES.L8-HML	2	\$7,385	\$1,205	\$2,110
36 x 72 x 42 high	UN2 L 367242RES.L8-HML	2	\$7,450	\$1,220	\$2,135
36 x 84 x 29 high	UN2 L 368429RES.L8-HML	2	\$7,780	\$1,230	\$2,155
36 x 84 x 36 high	UN2 L 368436RES.L8-HML	2	\$7,845	\$1,245	\$2,180
36 x 84 x 42 high	UN2 L 368442RES.L8-HML	2	\$7,905	\$1,255	\$2,200
36 x 96 x 29 high	UN2 L 369629RES.L8-HML	2	\$7,970	\$1,270	\$2,225
36 x 96 x 36 high	UN2 L 369636RES.L8-HML	2	\$8,030	\$1,280	\$2,245
36 x 96 x 42 high	UN2 L 369642RES.L8-HML	2	\$8,095	\$1,295	\$2,265
36 x 120 x 29 high	UN2 L 3612029RES.L8-HML	2	\$9,180	\$1,330	\$2,330
36 x 120 x 36 high	UN2 L 3612036RES.L8-HML	2	\$9,245	\$1,345	\$2,355
36 x 120 x 42 high	UN2 L 3612042RES.L8-HML	2	\$9,305	\$1,355	\$2,375
36 x 144 x 29 high	UN2 L 3614429RES.L8-HML	3	\$14,275	\$2,135	\$3,735
36 x 144 x 36 high	UN2 L 3614436RES.L8-HML	3	\$14,335	\$2,145	\$3,755
36 x 144 x 42 high	UN2 L 3614442RES.L8-HML	3	\$14,400	\$2,160	\$3,780
36 x 168 x 29 high	UN2 L 3616829RES.L8-HML	3	\$15,085	\$2,295	\$4,020
36 x 168 x 36 high	UN2 L 3616836RES.L8-HML	3	\$15,150	\$2,310	\$4,040
36 x 168 x 42 high	UN2 L 3616842RES.L8-HML	3	\$15,210	\$2,320	\$4,065

FOR POWER & A/V OPTIONS  
SEE PAGES 8-20



Power location code includes location on the table and the orientation of the power box.

Use these codes for mounting Cove power into Union panel bases.

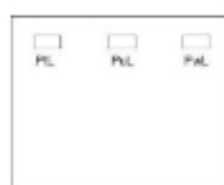

# Union 2.0 Half Modesty Panel

www.hi5furniture.com Questions? 816-774-4050

March 1, 2018



**FINISHES NEEDED:** <http://hi5furniture.com/finishes/>

HPL Color: Hi5 Graded-in laminates or Non-Premium Wilsonart or Formica

Edge Color: Hi5 Graded-in laminates or Non-Premium Wilsonart or Formica

Modesty Panel Color: Hi5 Graded-in laminates or Non-Premium Wilsonart or Formica

Panel Base Bracket Color: Any Hi5 standard

Modesty Panel Corner Bracket Color:

Table Size	Model Code:	Base QTY	Price for: Half Modesty	Upcharge for VDL/Premium Laminate	Upcharge for Color Core
42 x 60 x 29 high	UN2 L 426029RES.L8-HML	2	\$7,200	\$1,170	\$2,045
42 x 60 x 36 high	UN2 L 426036RES.L8-HML	2	\$7,260	\$1,180	\$2,070
42 x 60 x 42 high	UN2 L 426042RES.L8-HML	2	\$7,510	\$1,230	\$2,155
42 x 72 x 29 high	UN2 L 427229RES.L8-HML	2	\$7,635	\$1,255	\$2,200
42 x 72 x 36 high	UN2 L 427236RES.L8-HML	2	\$7,700	\$1,270	\$2,225
42 x 72 x 42 high	UN2 L 427242RES.L8-HML	2	\$7,760	\$1,280	\$2,245
42 x 84 x 29 high	UN2 L 428429RES.L8-HML	2	\$8,405	\$1,355	\$2,375
42 x 84 x 36 high	UN2 L 428436RES.L8-HML	2	\$8,470	\$1,370	\$2,400
42 x 84 x 42 high	UN2 L 428442RES.L8-HML	2	\$8,530	\$1,380	\$2,420
42 x 96 x 29 high	UN2 L 429629RES.L8-HML	2	\$8,595	\$1,395	\$2,440
42 x 96 x 36 high	UN2 L 429636RES.L8-HML	2	\$8,655	\$1,405	\$2,460
42 x 96 x 42 high	UN2 L 429642RES.L8-HML	2	\$8,720	\$1,420	\$2,485
42 x 120 x 29 high	UN2 L 4212029RES.L8-HML	2	\$10,120	\$1,520	\$2,660
42 x 120 x 36 high	UN2 L 4212036RES.L8-HML	2	\$10,180	\$1,530	\$2,680
42 x 120 x 42 high	UN2 L 4212042RES.L8-HML	2	\$10,245	\$1,545	\$2,705
42 x 144 x 29 high	UN2 L 4214429RES.L8-HML	3	\$15,525	\$2,385	\$4,175
42 x 144 x 36 high	UN2 L 4214436RES.L8-HML	3	\$15,585	\$2,395	\$4,195
42 x 144 x 42 high	UN2 L 4214442RES.L8-HML	3	\$15,650	\$2,410	\$4,220
42 x 168 x 29 high	UN2 L 4216829RES.L8-HML	3	\$16,335	\$2,545	\$4,455
42 x 168 x 36 high	UN2 L 4216836RES.L8-HML	3	\$16,400	\$2,560	\$4,480
42 x 168 x 42 high	UN2 L 4216842RES.L8-HML	3	\$16,460	\$2,570	\$4,500

FOR POWER & A/V OPTIONS  
SEE PAGES 8-20



Power location code includes location on the table and the orientation of the power box.

Use these codes for mounting Cove power into Union panel bases.



# Union 2.0 Half Modesty Panel

www.hi5furniture.com Questions? 816-774-4050

March 1, 2018



**FINISHES NEEDED:** <http://hi5furniture.com/finishes/>

HPL Color: Hi5 Graded-in laminates or Non-Premium Wilsonart or Formica

Edge Color: Hi5 Graded-in laminates or Non-Premium Wilsonart or Formica

Modesty Panel Color: Hi5 Graded-in laminates or Non-Premium Wilsonart or Formica

Panel Base Bracket Color: Any Hi5 standard

Modesty Panel Corner Bracket Color:

Table Size	Model Code:	Base QTY	Price for: Half Modesty	Upcharge for VDL/Premium Laminate	Upcharge for Color Core
48 x 60 x 29 high	UN2L486029RES.L8-HML	2	\$7,510	\$1,230	\$2,155
48 x 60 x 36 high	UN2L486036RES.L8-HML	2	\$7,575	\$1,245	\$2,180
48 x 60 x 42 high	UN2L486042RES.L8-HML	2	\$7,825	\$1,295	\$2,265
48 x 72 x 29 high	UN2L487229RES.L8-HML	2	\$7,950	\$1,320	\$2,310
48 x 72 x 36 high	UN2L487236RES.L8-HML	2	\$8,010	\$1,330	\$2,330
48 x 72 x 42 high	UN2L487242RES.L8-HML	2	\$8,075	\$1,345	\$2,355
48 x 84 x 29 high	UN2L488429RES.L8-HML	2	\$9,030	\$1,480	\$2,595
48 x 84 x 36 high	UN2L488436RES.L8-HML	2	\$9,095	\$1,495	\$2,615
48 x 84 x 42 high	UN2L488442RES.L8-HML	2	\$9,155	\$1,505	\$2,635
48 x 96 x 29 high	UN2L489629RES.L8-HML	2	\$9,220	\$1,520	\$2,660
48 x 96 x 36 high	UN2L489636RES.L8-HML	2	\$9,280	\$1,530	\$2,680
48 x 96 x 42 high	UN2L489642RES.L8-HML	2	\$9,345	\$1,545	\$2,705
48 x 120 x 29 high	UN2L4812029RES.L8-HML	2	\$11,055	\$1,705	\$2,985
48 x 120 x 36 high	UN2L4812036RES.L8-HML	2	\$11,120	\$1,720	\$3,010
48 x 120 x 42 high	UN2L4812042RES.L8-HML	2	\$11,180	\$1,730	\$3,030
48 x 144 x 29 high	UN2L4814429RES.L8-HML	3	\$18,010	\$2,880	\$5,045
48 x 144 x 36 high	UN2L4814436RES.L8-HML	3	\$18,080	\$2,895	\$5,070
48 x 144 x 42 high	UN2L4814442RES.L8-HML	3	\$18,150	\$2,910	\$5,095
48 x 168 x 29 high	UN2L4816829RES.L8-HML	3	\$18,920	\$3,065	\$5,360
48 x 168 x 36 high	UN2L4816836RES.L8-HML	3	\$18,990	\$3,080	\$5,385
48 x 168 x 42 high	UN2L4816842RES.L8-HML	3	\$19,060	\$3,090	\$5,410

FOR POWER & A/V OPTIONS  
SEE PAGES 8-20



Power location code includes location on the table and the orientation of the power box.

Use these codes for mounting Cove power into Union panel bases.



# Union 2.0 Half Modesty Panel

www.hi5furniture.com Questions? 816-774-4050

March 1, 2018



**FINISHES NEEDED:** <http://hi5furniture.com/finishes/>

HPL Color: Hi5 Graded-in laminates or Non-Premium Wilsonart or Formica

Edge Color: Hi5 Graded-in laminates or Non-Premium Wilsonart or Formica

Modesty Panel Color: Hi5 Graded-in laminates or Non-Premium Wilsonart or Formica

Panel Base Bracket Color: Any Hi5 standard

Modesty Panel Corner Bracket Color:

Table Size	Model Code:	Base QTY	Price for: Half Modesty	Upcharge for VDL/Premium Laminate	Upcharge for Color Core
60 x 60 x 29 high	UN2 L 606029SQS.L8-HML	2	\$8,445	\$1,420	N/A
60 x 60 x 36 high	UN2 L 606036SQS.L8-HML	2	\$8,515	\$1,435	N/A
60 x 60 x 42 high	UN2 L 606042SQS.L8-HML	2	\$8,795	\$1,490	N/A
60 x 72 x 29 high	UN2 L 607229RES.L8-HML	2	\$8,935	\$1,515	N/A
60 x 72 x 36 high	UN2 L 607236RES.L8-HML	2	\$9,005	\$1,530	N/A
60 x 72 x 42 high	UN2 L 607242RES.L8-HML	2	\$9,075	\$1,545	N/A
60 x 84 x 29 high	UN2 L 608429RES.L8-HML	2	\$10,465	\$1,770	N/A
60 x 84 x 36 high	UN2 L 608436RES.L8-HML	2	\$10,535	\$1,785	N/A
60 x 84 x 42 high	UN2 L 608442RES.L8-HML	2	\$10,605	\$1,795	N/A
60 x 96 x 29 high	UN2 L 609629RES.L8-HML	2	\$10,675	\$1,810	N/A
60 x 96 x 36 high	UN2 L 609636RES.L8-HML	2	\$10,745	\$1,825	N/A
60 x 96 x 42 high	UN2 L 609642RES.L8-HML	2	\$10,815	\$1,840	N/A
60 x 120 x 29 high	UN2 L 6012029RES.L8-HML	2	\$12,975	\$2,090	N/A
60 x 120 x 36 high	UN2 L 6012036RES.L8-HML	2	\$13,045	\$2,105	N/A
60 x 120 x 42 high	UN2 L 6012042RES.L8-HML	2	\$13,115	\$2,120	N/A
60 x 144 x 29 high	UN2 L 6014429RES.L8-HML	3	\$19,410	\$3,160	N/A
60 x 144 x 36 high	UN2 L 6014436RES.L8-HML	3	\$19,480	\$3,175	N/A
60 x 144 x 42 high	UN2 L 6014442RES.L8-HML	3	\$19,550	\$3,190	N/A
60 x 168 x 29 high	UN2 L 6016829RES.L8-HML	3	\$20,320	\$3,345	N/A
60 x 168 x 36 high	UN2 L 6016836RES.L8-HML	3	\$20,390	\$3,360	N/A
60 x 168 x 42 high	UN2 L 6016842RES.L8-HML	3	\$20,460	\$3,370	N/A

FOR POWER & A/V OPTIONS  
SEE PAGES 8-20



Power location code includes location on the table and the orientation of the power box.

Use these codes for mounting Cove power into Union panel bases.



# Union 2.0 Hybrid

www.hi5furniture.com Questions? 816-774-4050

March 1, 2018



**FINISHES NEEDED:** <http://hi5furniture.com/finishes/>

HPL Color: Hi5 Graded-in laminates or Non-Premium Wilsonart or Formica  
Edge Color: Hi5 Graded-in laminates or Non-Premium Wilsonart or Formica  
Accent Laminate Color, if any.

Panel Base Bracket Color: Any Hi5 standard

Base Color: Any Hi5 standard

Table Size	Model Code:	Base QTY	Price for: CobySquare Hybrid	Upcharge for VDL/Premium Laminate	Upcharge for Color Core
24 x 60 x 29 high	UN2 L 246029 RES.L8-CYSQ	2	\$5,535	\$1,030	\$1,805
24 x 60 x 36 high	UN2 L 246036 RES.L8-CYSQ	2	\$5,660	\$1,055	\$1,850
24 x 60 x 42 high	UN2 L 246042 RES.L8-CYSQ	2	\$5,815	\$1,090	\$1,905
24 x 72 x 29 high	UN2 L 247229 RES.L8-CYSQ	2	\$5,975	\$1,120	\$1,960
24 x 72 x 36 high	UN2 L 247236 RES.L8-CYSQ	2	\$6,035	\$1,130	\$1,980
24 x 72 x 42 high	UN2 L 247242 RES.L8-CYSQ	2	\$6,160	\$1,155	\$2,025
24 x 84 x 29 high	UN2 L 248429 RES.L8-CYSQ	2	\$6,225	\$1,170	\$2,045
24 x 84 x 36 high	UN2 L 248436 RES.L8-CYSQ	2	\$6,255	\$1,175	\$2,060
24 x 84 x 42 high	UN2 L 248442 RES.L8-CYSQ	2	\$6,285	\$1,180	\$2,070
30 x 60 x 29 high	UN2 L 306029 RES.L8-CYSQ	2	\$5,725	\$1,070	\$1,870
30 x 60 x 36 high	UN2 L 306036 RES.L8-CYSQ	2	\$5,785	\$1,080	\$1,895
30 x 60 x 42 high	UN2 L 306042 RES.L8-CYSQ	2	\$6,035	\$1,130	\$1,980
30 x 72 x 29 high	UN2 L 307229 RES.L8-CYSQ	2	\$6,160	\$1,155	\$2,025
30 x 72 x 36 high	UN2 L 307236 RES.L8-CYSQ	2	\$6,225	\$1,170	\$2,045
30 x 72 x 42 high	UN2 L 307242 RES.L8-CYSQ	2	\$6,285	\$1,180	\$2,070
30 x 84 x 29 high	UN2 L 308429 RES.L8-CYSQ	2	\$6,350	\$1,195	\$2,090
30 x 84 x 36 high	UN2 L 308436 RES.L8-CYSQ	2	\$6,410	\$1,205	\$2,110
30 x 84 x 42 high	UN2 L 308442 RES.L8-CYSQ	2	\$6,475	\$1,220	\$2,135

FOR POWER & A/V OPTIONS  
SEE PAGES 8-20



Power location code includes location on the table and the orientation of the power box.

Use these codes for mounting Cove power into Union panel bases.



# Union 2.0 Hybrid

www.hi5furniture.com Questions? 816-774-4050

March 1, 2018

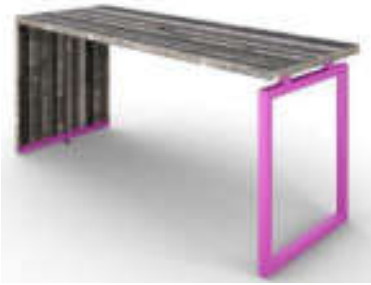

**FINISHES NEEDED:** <http://hi5furniture.com/finishes/>

HPL Color: Hi5 Graded-in laminates or Non-Premium Wilsonart or Formica  
Edge Color: Hi5 Graded-in laminates or Non-Premium Wilsonart or Formica  
Accent Laminate Color, if any.

Panel Base Bracket Color: Any Hi5 standard

Base Color: Any Hi5 standard

Table Size	Model Code:	Base QTY	Price for: CobySquare Hybrid	Upcharge for VDL/Premium Laminate	Upcharge for Color Core
36 x 60 x 29 high	UN2 L 366029 RES.L8-CYSQ	2	\$5,910	\$1,105	\$1,935
36 x 60 x 36 high	UN2 L 366036 RES.L8-CYSQ	2	\$5,975	\$1,120	\$1,960
36 x 60 x 42 high	UN2 L 366042 RES.L8-CYSQ	2	\$6,225	\$1,170	\$2,045
36 x 72 x 29 high	UN2 L 367229 RES.L8-CYSQ	2	\$6,350	\$1,195	\$2,090
36 x 72 x 36 high	UN2 L 367236 RES.L8-CYSQ	2	\$6,410	\$1,205	\$2,110
36 x 72 x 42 high	UN2 L 367242 RES.L8-CYSQ	2	\$6,475	\$1,220	\$2,135
36 x 84 x 29 high	UN2 L 368429 RES.L8-CYSQ	2	\$6,535	\$1,230	\$2,155
36 x 84 x 36 high	UN2 L 368436 RES.L8-CYSQ	2	\$6,600	\$1,245	\$2,180
36 x 84 x 42 high	UN2 L 368442 RES.L8-CYSQ	2	\$6,660	\$1,255	\$2,200
42 x 60 x 29 high	UN2 L 426029 RES.L8-CYSQ	2	\$6,225	\$1,170	\$2,045
42 x 60 x 36 high	UN2 L 426036 RES.L8-CYSQ	2	\$6,285	\$1,180	\$2,070
42 x 60 x 42 high	UN2 L 426042 RES.L8-CYSQ	2	\$6,535	\$1,230	\$2,155
42 x 72 x 29 high	UN2 L 427229 RES.L8-CYSQ	2	\$6,660	\$1,255	\$2,200
42 x 72 x 36 high	UN2 L 427236 RES.L8-CYSQ	2	\$6,725	\$1,270	\$2,225
42 x 72 x 42 high	UN2 L 427242 RES.L8-CYSQ	2	\$6,785	\$1,280	\$2,245
42 x 84 x 29 high	UN2 L 428429 RES.L8-CYSQ	2	\$7,160	\$1,355	\$2,375
42 x 84 x 36 high	UN2 L 428436 RES.L8-CYSQ	2	\$7,225	\$1,370	\$2,400
42 x 84 x 42 high	UN2 L 428442 RES.L8-CYSQ	2	\$7,285	\$1,380	\$2,420

FOR POWER & A/V OPTIONS  
SEE PAGES 8-20



Power location code includes location on the table and the orientation of the power box.

Use these codes for mounting Cove power into Union panel bases.

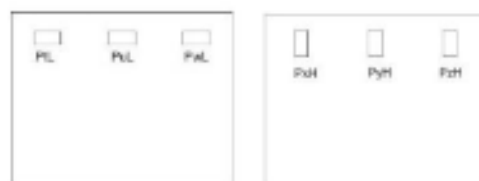



# Union 2.0 Hybrid

www.hi5furniture.com Questions? 816-774-4050

March 1, 2018

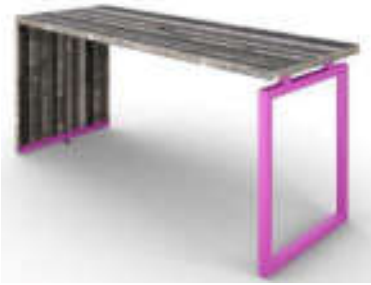

**FINISHES NEEDED:** <http://hi5furniture.com/finishes/>

HPL Color: Hi5 Graded-in laminates or Non-Premium Wilsonart or Formica  
Edge Color: Hi5 Graded-in laminates or Non-Premium Wilsonart or Formica  
Accent Laminate Color, if any.

Panel Base Bracket Color: Any Hi5 standard

Base Color: Any Hi5 standard

Table Size	Model Code:	Base QTY	Price for: CobySquare Hybrid	Upcharge for VDL/Premium Laminate	Upcharge for Color Core
48 x 60 x 29 high	UN2 L486029RES.L8-CYSQ	2	\$6,535	\$1,230	\$2,155
48 x 60 x 36 high	UN2 L486036RES.L8-CYSQ	2	\$6,600	\$1,245	\$2,180
48 x 60 x 42 high	UN2 L486042RES.L8-CYSQ	2	\$6,850	\$1,295	\$2,265
48 x 72 x 29 high	UN2 L487229RES.L8-CYSQ	2	\$6,975	\$1,320	\$2,310
48 x 72 x 36 high	UN2 L487236RES.L8-CYSQ	2	\$7,035	\$1,330	\$2,330
48 x 72 x 42 high	UN2 L487242RES.L8-CYSQ	2	\$7,100	\$1,345	\$2,355
48 x 84 x 29 high	UN2 L488429RES.L8-CYSQ	2	\$7,785	\$1,480	\$2,595
48 x 84 x 36 high	UN2 L488436RES.L8-CYSQ	2	\$7,850	\$1,495	\$2,615
48 x 84 x 42 high	UN2 L488442RES.L8-CYSQ	2	\$7,910	\$1,505	\$2,635
60 x 60 x 29 high	UN2 L606029SQS.L8-CYSQ	2	\$7,470	\$1,420	N/A
60 x 60 x 36 high	UN2 L606036SQS.L8-CYSQ	2	\$7,540	\$1,435	N/A
60 x 60 x 42 high	UN2 L606042SQS.L8-CYSQ	2	\$7,820	\$1,490	N/A
60 x 72 x 29 high	UN2 L607229RES.L8-CYSQ	2	\$7,960	\$1,515	N/A
60 x 72 x 36 high	UN2 L607236RES.L8-CYSQ	2	\$8,030	\$1,530	N/A
60 x 72 x 42 high	UN2 L607242RES.L8-CYSQ	2	\$8,100	\$1,545	N/A
60 x 84 x 29 high	UN2 L608429RES.L8-CYSQ	2	\$9,220	\$1,770	N/A
60 x 84 x 36 high	UN2 L608436RES.L8-CYSQ	2	\$9,290	\$1,785	N/A
60 x 84 x 42 high	UN2 L608442RES.L8-CYSQ	2	\$9,360	\$1,795	N/A

FOR POWER & A/V OPTIONS  
SEE PAGES 8-20



Power location code includes location on the table and the orientation of the power box.

Use these codes for mounting Cove power into Union panel bases.

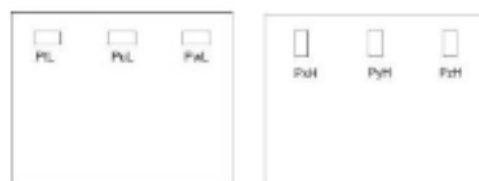

# Union 2.0 Multi-Height Models

www.hi5furniture.com Questions? 816-774-4050

March 1, 2018



**FINISHES NEEDED:** <http://hi5furniture.com/finishes/>

HPL Color: Hi5 Graded-in laminates or Non-Premium Wilsonart or Formica

Edge Color: Hi5 Graded-in laminates or Non-Premium Wilsonart or Formica

Panel Base Bracket Color: Any Hi5 standard

Accent Color: Hi5 Graded-in laminates or Non-Premium Wilsonart or Formica

ONLY AVAILABLE INSIDE SURFACE OF THE TWO OUTSIDE BASES ON MULTI-HEIGHT TABLES

Size of Each Section	Overall Width & Length	Model Code:	Base QTY	Price for: Multi Height
24x72x29 24x72x42	24 x 144	UN2L247229x247242 RES.L8	3	\$11,385
24x72x29 24x72x36 24x72x42	24 x 216	UN2L247229x247236x247242 RES.L8	4	\$17,170
30x72x29 30x72x42	30 x 144	UN2L307229x307242 RES.L8	3	\$11,695
30x72x29 30x72x36 30x72x42	30 x 216	UN2L307229x307236x307242 RES.L8	4	\$17,545
36x72x29 36x72x42	36 x 144	UN2L367229x367242 RES.L8	3	\$12,075
36x72x29 36x96x36 36x96x42	36 x 264	UN2L367229x369636x369642 RES.L8	4	\$18,920
42x72x29 42x72x42	42 x 144	UN2L427229x427242 RES.L8	3	\$12,695
42x72x29 42x96x36 42x96x42	42 x 264	UN2L427229x429636x429642 RES.L8	4	\$20,420
48x72x29 48x72x42	48 x 144	UN2L487229x487242 RES.L8	3	\$13,325
48x72x29 48x96x36 48x96x42	48 x 264	UN2L487229x489636x489642 RES.L8	4	\$21,985
60x72x29 60x72x42	60 x 144	UN2L607229x607242 RES.L8	3	\$15,310
60x72x29 60x96x36 60x96x42	60 x 264	UN2L607229x609636x609642 RES.L8	4	\$25,905

Due to the endless size options – please email [Sales@Hi5Furniture.com](mailto:Sales@Hi5Furniture.com) with your size requirements for a quote.

NOTE: Extremely heavy product - minimum 6 experienced installers are required to install this model.

FOR POWER & A/V OPTIONS  
SEE PAGES 8-20



Power location code includes location on the table and the orientation of the power box.

Use these codes for mounting Cove power into Union panel bases.

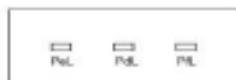

**Base Model Code :**

**CY**      **ST**      **3696**      **42**      **RE**      **S**      **L3**      **-Options in Alphabetical Order**  
 Product Line      Base style      Top size      Table Height      Top shape      Table function      Top edge

PRODUCT LINE CODES		BASE STYLE CODES		TOP SHAPE CODES		TABLE FUNCTION CODE	
AN	Arlington	C1	C base with 1 column	BT	Boat	BN	Beam Nesting
AX	aFIX	T1	T base with 1 column	CR	Crescent	E2	Electric 2stage
CY	Coby	T2	TT base with 2 columns	CS	Custom Shaped	E3	Electric 3stage
EE	Empire	X1	X base with 1 column	DS	D Shape	F	Folding
GY	Gateway	X4	X base with 4 columns	EL	Elliptical / Oval	H	Hand Crank
HR	Harbor	Y0	Y base without stretcher	GP	Guitar Pick	P	Pneumatic
ID	Island	Y1	Y base with 1 stretcher	HR	Half Round	N	Nesting
LN	Lincoln	D1	Disc Round with 1 column	HX	Hexagon	S	Stationary
OC/S/R	Pinnacle	Q1	Disc Square with 1 column	KD	Kidney		
RY	Railway	D8	8" aFIX base	PE	Pie		
SP	Supreme	P2	Square 2" Post Bases	QR	Quarter Round		
UN2L	Union 2.0	P2	Round 2" Post Leg	RD	Round		
		P3	Round 3" Post Leg	RE	Rectangle		
		P4	Round 4" Post Leg	RT	Racetrack		
		P6	Round 6" Post Leg	SQ	Square		
			<b><u>COBY APRON</u></b>	SR	Soft Rectangle		
		A0	Apron Base without Footrail	ST	Soft Trapezoid		
		A1	Apron Base with 1 Footrail	TD	Tear Drop		
		A2	Apron Base with 2 Footrails	TW	Tele-wedge		
			<b><u>COBY SQUARE</u></b>	TZ	Trapezoid		
		SC	Square   Post Combo	VH	Video Conference		
		ST	Square Bases				
		SM	Square Inset   Post Combo				
			<b><u>LINCOLN</u></b>				
		UC	U   Post Combo				
		UT	U Bases				
		UM	U Inset   Post Combo				
			<b><u>RAILWAY</u></b>				
		CL	Conference   Cube HPL				
		PL	Panel HPL base				
		RL	Rectangle HPL base				
		UL	U shaped base in HPL				
			<b><u>DISCONTINUED:</u></b>				
		CV	Conference   Cube Veneer				
		PV	Panel Veneer base				
		RV	Rectangle Veneer base				
		TL	Training HPL base				
		TV	Training Veneer base				
		UV	U shaped base in Veneer				

**DISCONTINUED:**

AH Spring Pin Adjustable  
R Ratchet

## Ordering Information:

**How to Order:** Email orders to: [sales@hi5furniture.com](mailto:sales@hi5furniture.com)

1. Choose your base model code
2. Add edge code and options
3. Select finishes

When placing your order with Hi5 Furniture please be sure to include the following information:

- The Hi5 Quote Number, if applicable
- Net prices
- Any special discounts
- Complete and valid model code numbers
- All relevant laminate, edge, grommet and base colors – codes and description
- Sold to and Ship to addresses
- A purchase order number
- A contact name and phone number
- A requested ship date
- Clearly stated special instructions, if any.

## Purchase Orders

Orders may be placed by:

Fax 816-817-4910

E-mail: [SALES@hi5furniture.com](mailto:SALES@hi5furniture.com)

All orders must be confirmed in writing with a signature of authorized buyer before beginning production.

## Eligibility

Hi5 Furniture, Inc.'s products are sold nationally through authorized furniture dealers. Possession of this price list does constitute authorization to sell and/or purchase products listed herein.

## New Dealer Accounts

All orders are subject to Hi5 Furniture's credit department. First time orders under \$2,000 net must be paid in advance. Orders over \$2,000 net require a 50% deposit. New account orders in MO and FL must be accompanied by a State Resale/Exemption Certificate or sales tax will be charged. Hi5 Furniture's is not responsible for collecting sales tax in any other state. If you are not tax exempt, sales tax must be self-assessed. Credit approval process could take up to 10 days. Orders will not begin production until credit approval is complete unless prepaid. Hi5 Furniture may review, change, or cancel credit terms and/or request advance payment at any time.

## Terms

Orders over \$20,000 net require a 50% deposit with standard approved terms of Net 30 from the date of invoice. All past due accounts will accrue a 2% per month service charge. Hi5 Furniture reserves the right to withhold production or shipment of completed products due to any past due invoices or failure to satisfy credit requirements.

## Choice of Law and Choices of Form

By placing an order with Hi5 Furniture, Inc. this order, and the contract hereby created, shall be deemed to be made in Platte County, Missouri regardless of the location of any office or representative of the customer or location of any of the equipment or furniture or place of signing by any party. This Agreement shall be governed by Missouri law. The venue for any claim arising under this Agreement shall be in the Platte County, Missouri.

## Credit Card

Hi5 accepts MasterCard and Visa. There is a 5% convenience fee charged on all charges.

## Prices

All prices listed herein are effective on the date printed on the cover and supersede all previous contract price lists and/or brochures. Prices do not include storage, installation or freight charges. See freight policy for details. Products specifications and pricing can change at any time without prior notice.

## Custom Products

Hi5 Furniture has made every effort to offer a broad range of standard products. We welcome the opportunity to provide a custom quote based on your input. Please Contact Factory for details. Hi5 Furniture cannot be responsible for space layout/design of products. We will provide recommendations based on your input. Custom products cannot be cancelled or returned. Custom products require a 50% deposit before production begins.

## Storage

Items held at Hi5 Furniture's more than thirty days after completed scheduled ship date are invoiced and storage charges will begin accruing at that time. Storage fees are based on the net total and are charged as follows: One month 2%, Two months 4%, Three months 8%, Four months 12%, and so on.

## Order Acknowledgements

All orders are acknowledged upon entering as Hi5 Furniture interprets them. All acknowledgements are sent via fax or e-mail at attention the contact name on the purchase order received. It is the customer's responsibility to note any discrepancies on the acknowledgement and notify Hi5 Furniture within 48 hours. If Hi5 Furniture does not receive a signed approval sheet or notification of any changes within 48 hours, we will assume that the order is correct and are not responsible for changes or errors. Hi5 Furniture lists an estimated ship date on every acknowledgement. Any order that is time sensitive or requires any special instructions, please note instructions and/or requirements on purchase order and we will make every attempt to accommodate your request. Hi5 Furniture is not responsible for any labor charges or installation fees if the shipping date does not meet your requirements.

# Warranty & Terms

Questions ? 816-774-4050

March 1, 2018

## Order Changes – Restocking Fees

Hi5 Furniture is a contract furniture company producing quality, finished products on a "just-in-time" basis to the purchaser's specifications. No finished product is inventoried. Should changes to a submitted purchase order be necessary and depending on where the order stands in the manufacturing timeline, every effort will be made to accommodate the change. Canceled orders are permitted 48 hours after the order has been entered at no charge. All other cancelled orders are subject to a 50% restocking fee. No returns are allowed.

All requests for cancellations or returns must be submitted in writing for approval by Hi5 Furniture. Please include the following information with your request; Copy of your original sales order and reason for requested cancellation or return.

## Orders Approved for Return

An RMA (Return Materials Authorization) will be sent with details for return. All products must be packed as they were originally received and returned freight prepaid to our factory unless otherwise noted on RMA. Customer is responsible for any additional damages in transit due to improper packaging. No collect shipments will be accepted for any reason. Please clearly mark all packages with RMA# to expedite RMA process.

## Freight

All products are shipped in compliance with the National Motor Freight Classification Code. All products ship unassembled unless otherwise specified by Hi5 Furniture. Hi5 Furniture can not be held accountable for delivery of goods to installation sites that are not equipped with elevators, loading docks that accommodate 53-foot trailers or for the inspection of such sites prior to delivery. Freight is dock-to-dock bases using Hi5's carrier.

Freight Zone #1: Please add \$200 net for orders less than \$2k net. Freight prepaid otherwise.

Freight Zone #2: Please add \$300 net for orders less than \$3k net. Freight prepaid otherwise.

Freight Program is within the Continental United States Only. All freight from that point is the responsibility of the Dealership and/or purchasing customer.

Hi5 Furniture shall not be held liable for delays caused by strikes, catastrophes, wars, riots or any other cause beyond our control.

## Additional Freight Charges

All products are shipped FOB origin based on a dock to dock delivery only. Additional expenses will be debited from customer account and billed on as "shipping/handling." Examples of additional expenses are: Inside delivery, Residential delivery and Lift gate requirements all have variable charges.

Failure to inspect product at time of receipt, note damages on delivery receipt and/or notify Hi5 Furniture of damages within 10 days of the original date of receipt constitutes acceptance of products and a waiver of all claims. Neither Hi5 Furniture nor the carrier will be responsible for concealed damage claims if shipments are left unopened. CONCEALED DAMAGE MUST BE REPORTED WITHIN 7 DAYS FROM DELIVERY TO BE VALID. Any concealed damage reported after 7 days will not be accepted by Hi5 Furniture and is the responsibility of the customer.

## Damaged Freight

All products are loaded on carrier trucks free from defects and/or damage. Responsibility of safe delivery and transport of products is assumed by the carrier upon loading. It is the customer's responsibility that all cartons, crates and packages be opened and inspected at time of delivery for damages or shortages regardless of condition. Any damages found during inspection must be clearly noted on the delivery receipt. The carriers should be notified and all packages left in original condition as received for inspection from carrier. Hi5 Furniture factory should be notified immediately. All freight claims are to be processed with the carrier, not Hi5 Furniture.

## LIMITED LIFETIME WARRANTY

The following Hi5 Furniture warranty applies to products manufactured after August 1, 2017.

This warranty is given to the end user and is valid for as long as the product is owned by that user. All warranties are considered registered unless, the end user is not provided at the time of the order, then the warranty does not apply. The warranty, which runs from the date of shipment, covers defects in materials and craftsmanship found during normal usage of the product during the warranty period. If a product is defective, and if written notice of the defect is given to Hi5 Furniture within the Applicable Warranty Period, Hi5 Furniture at its option will either repair or replace the defective product with a comparable component or product. Defective product shall be returned at the discretion of Hi5 Furniture and all returns must be authorized in writing in advance including a Return Materials Authorization Number. Hi5 Furniture, Inc. assumes no responsibility for labor or delivery charges. Freight charges for defective products and parts will be covered by Hi5 Furniture within the 48 continental United States with the method of shipping at Hi5 Furniture's discretion. The limitations of the Limited Lifetime Warranty include:

Electrical Products: Five (5) years

Wood, wood edges, glass, base glides, casters, adjustable height mechanisms, folding mechanisms, nesting or flipping mechanisms, self edges, table gangers, self adhesive wire management parts, modesty panels, hardware, CPU holders, divider panels, or any moving parts have a (1) year warranty.

Non-standard products: One (1) year

Third party specified and supplied products: Suppliers Warranty

WARRANTY IS VOID IF INVOICE IS NOT PAID ON TIME FOR ANY REASON.

All items should be inspected at two month intervals for missing glides, loose screws, broken or cracked welds, loose or unseated columns, etc. All specifications are subject to change without notice.

This warranty does not apply to damage caused by a carrier, alterations to the product not expressly authorized by Hi5 Furniture. It also does not apply to "Customer's Own Material" (i.e. material supplied by the customer that is not a standard Hi5 Furniture product offering) used in the manufacture of Hi5 Furniture products. Hi5 Furniture does not warrant the matching of color, grain or texture except to within commercially acceptable standards. A Product will not be considered defective and Hi5 Furniture will not be obligated to replace it, if the product is not installed or used as recommended by Hi5 Furniture.